

HÄFELE

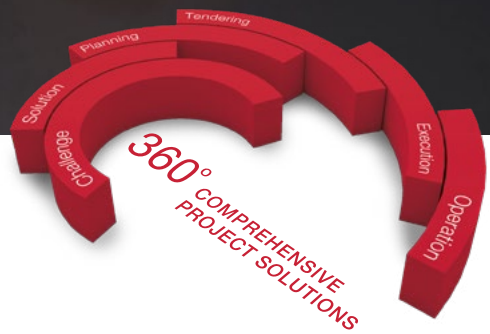

HÄFELE PROJECTS 360°
ARCHITECTURAL IRONMONGERY





CONTENTS



SERVICES 2



LEVER HANDLES 6



PULL HANDLES 36



DOOR KNOBS 46



HINGES 52



DOOR CONTROL 66



LOCKS & LATCHES 82



FLUSH HANDLES 100



ANCILLARY ITEMS 106



WELCOME TO THE HÄFELE PROJECTS 360° ARCHITECTURAL IRONMONGERY BROCHURE.

Our ranges consist of a vast assortment of items. The products we specify have been carefully chosen to suit any building project from hospitality, commercial, education, retail and leisure.

We work closely with architects and interior designers as well as clients, developers, and a host of main and sub-contractors. Häfele can specify, source and supply any product to suit the functionality and design of your building. If you can't find the design that you're looking for, we offer a bespoke manufacturing service to your exact requirements.

The Projects 360° team are all Dip GAI qualified and collectively have racked up over 100 years of experience in the architectural hardware industry. The team adopts 'cradle-to-grave' approach when supporting clients and as well as first class product knowledge can offer assistance through a number of services and solutions.

Thank you for choosing Häfele as your architectural ironmongery partner, we look forward to working with you.

Paul Smith
Head of Specification Sales
HÄFELE UK

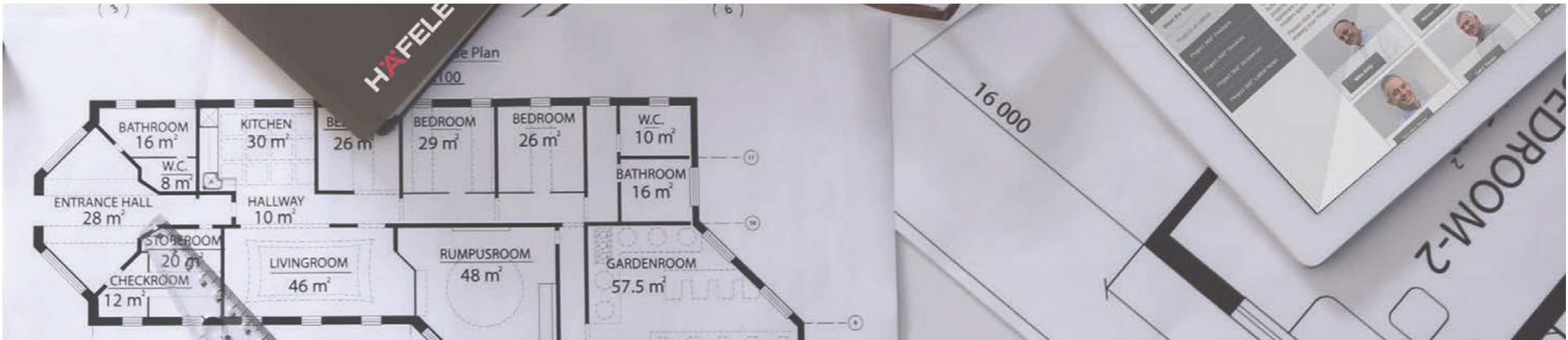

The Projects 360° team are so called because of their complete service approach to client support in design, specification and implementation. We can offer a broad range of services to aid the planning, design and functionality of your project from start to finish, connecting you with the solutions to meet your projects' requirements and objectives.

DOOR-BY-DOOR SCHEDULING

Using our industry standard door scheduling software, the Projects 360° team can create accurate and detailed door-by-door schedules for projects of any shape or size. This document can be tailored to your requirements to include product imagery and pricing information, grouping similar products in hardware sets.

PRODUCT SPECIFICATION SERVICES

Häfele have a number of market-led architectural ironmongery solutions available in stock but the combination of a global supplier network and the knowledge of the Projects 360° team, means they are perfectly placed to support in the specification of the product you need, whatever the size of project, design or sector.

ASSET MANAGEMENT AND ACCESS

The Projects 360° team can offer a variety of 2D and 3D CAD drawings. We also have an increasing number of products being added to our BIM library. As an NBS partner we also enjoy a comprehensive range of NBS classed products through the NBS Chorus platform, as well as over 200 products within NBS source.

RIBA APPROVED CPDS

As a manufacturing supplier of RIBA members, we are able to offer two architectural ironmongery CPD presentations both face-to-face and delivered remotely. Specifying Architectural Hardware for Inclusive Design will help you understand the various legislation relating to universal access. Specifying Door Ironmongery: A Basic Guide is exactly that, a good introduction touching on the main considerations.

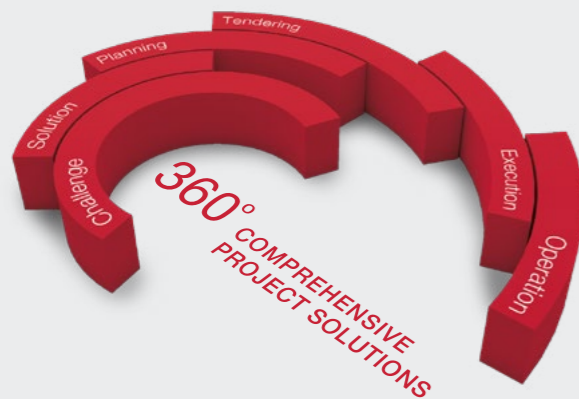

PLANNING SERVICES

We understand the importance of accuracy, attention to detail, and absolute functionality. The Projects 360° team can help with legislative and operational requirements to ensure your project meets building and fire safety standards and regulations, as well as providing strategy for fire and security access control.

IMPLEMENTATION SERVICES

The Häfele Projects 360° team can help ensure that your project runs smoothly throughout implementation with secure and reliable delivery from our international network. This means that we can ensure the safe arrival of products on site as and when they are needed and can offer bespoke logistics such as phased deliveries or door packed consignments.

TENDERING AND QUOTATION SERVICES

As part of the planning phase, here at Häfele we will provide honest, helpful and expert advice. Our experts can offer product or manufacturer specific or independent advice as and when required, meaning the Häfele Projects 360° team is a one-stop shop for all your architectural hardware planning needs.

TECHNICAL DATA SHEETS

Data sheets containing specific technical information can be found to view on-line on the NBS Source website. All products can also be "Copied to Spec" and used for your specification. Furthermore NBS Chorus members can add directly into their Project NBS Specification. Please click on this [link](#) here for immediate access.





LEVER HANDLES

The door furniture of a building makes a statement. Not only does it have to be aesthetically pleasing, with the finish to suit the overall decor, but it also has to be functional and durable. That's why Häfele's Project 360° team has worked closely with leading industry manufacturers from across the globe to bring you a selection of the most suitable lever handles on the market today.

Featured product CURVED LEVER HANDLE 316 STAINLESS STEEL
PROJECT CODE: HUKP-0101-29

SERVICES

LEVER HANDLES

PULL HANDLES

DOOR KNOBS

HINGES

DOOR CONTROLS

LOCKS & LATCHES

FLUSH HANDLES

ANCILLARY HARDWARE

<

>

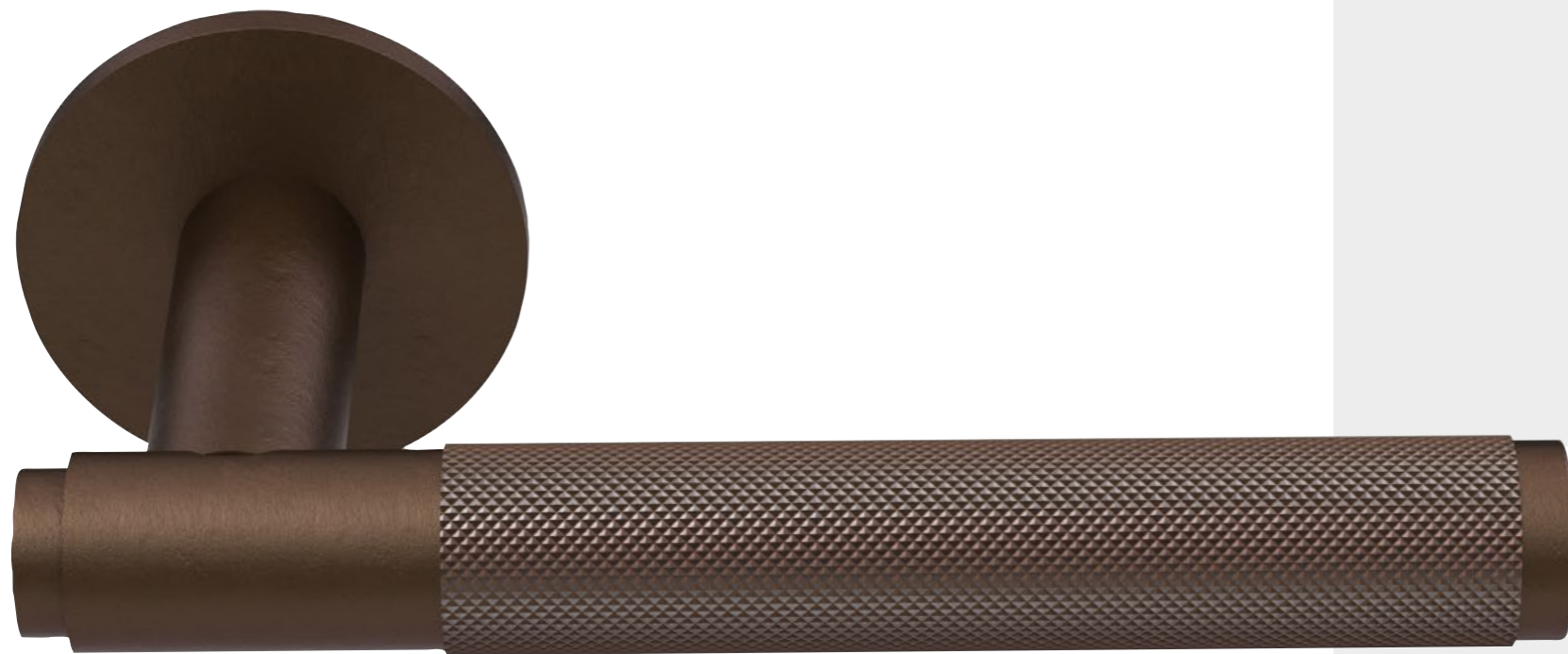

Satin
Stainless Steel



Polished
Stainless Steel

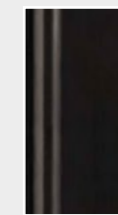

Matt
Black

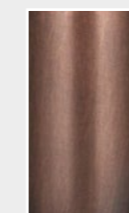

Light
Bronze*

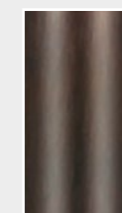

Dark
Bronze*



Häfele
Black



Polished
Brass



Satin
Brass



RAL
Colour*



FINISHES - A

Häfele door furniture in Grade 316 Stainless Steel is available as Polished or Satin Stainless Steel, with options of Electro-lacquer or PVD in Bronze, Brass & Black as shown with other finishes in RAL colour coating. Other PVD & Electro-lacquer colours are available to special order.

*Other finishes available to special order



RTD LEVER HANDLE 316 STAINLESS STEEL 16MM

PROJECT CODE: **HUKP-0101-01**

Return to Door design lever handle in solid bar stainless steel. Ball bearing concealed fixed rose with 4 point back to back fixing. Unsprung, for use with heavy duty followers. 52mm Ø and 4mm thick rose, 38mm c.c. for bolt through fixings. To suit door thickness from 35-54mm

Manufactured to BS EN1906: 2012 Class code: 4/7/-/1/1/4/0/U
316L Grade Stainless Steel for use in corrosive environments
Suitable for high frequency of use
EN1634-1:2000 suitable for use on fire resisting doors



Colours shown above correspond to finishes A - Page 9

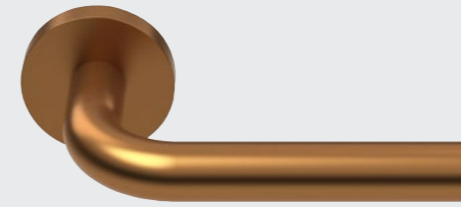

STRAIGHT LEVER HANDLE 316 STAINLESS STEEL 19MM

PROJECT CODE: **HUKP-0101-05**

Straight design lever handle in solid bar stainless steel. Ball bearing concealed fixed rose with 4 point back to back fixing. Unsprung, for use with heavy duty followers. 52mm Ø and 4mm thick rose, 38mm c.c. for bolt through fixings. To suit door thickness from 35-54mm

Manufactured to BS EN1906: 2012 Class code: 4/7/-/1/1/4/0/U
316L Grade Stainless Steel for use in corrosive environments
Suitable for high frequency of use EN4
EN1634-1:2000 suitable for use on fire resisting doors



Colours shown above correspond to finishes A - Page 9



RTD LEVER HANDLE 316 STAINLESS STEEL 19MM

PROJECT CODE: **HUKP-0101-02**

Return to Door design lever handle in solid bar stainless steel. Ball bearing concealed fixed rose with 4 point back to back fixing. Unsprung, for use with heavy duty followers. 52mm Ø and 4mm thick rose, 38mm c.c. for bolt through fixings. To suit door thickness from 35-54mm

Manufactured to BS EN1906: 2012 Class code: 4/7/-/1/1/4/0/U
316L Grade Stainless Steel for use in corrosive environments
Suitable for high frequency of use and for BS8300 applications
EN1634-1:2000 suitable for use on fire resisting doors



Colours shown above correspond to finishes A - Page 9

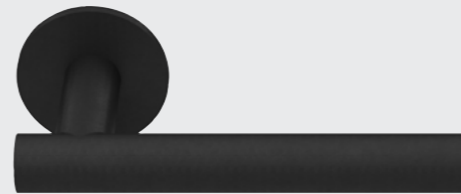

SOLID "T" BAR LEVER 316 STAINLESS STEEL

PROJECT CODE: **HUKP-0101-57**

Lever handle straight design in solid bar stainless steel. Ball bearing concealed fixed rose with 4 point back to back fixing. Unsprung, for use with heavy duty followers. 52mm Ø and 4mm thick rose, 38mm c.c. for bolt through fixings. To suit door thickness from 35-54mm

Manufactured to BS EN1906: 2012 Class code: 4/7/-/1/1/4/0/U
316L Grade Stainless Steel for use in corrosive environments
Suitable for high frequency to EN4
EN1634-1:2000 suitable for use on fire resisting doors



Colours shown above correspond to finishes A - Page 9



STRAIGHT LEVER HANDLE 316 STAINLESS STEEL 16MM

PROJECT CODE: **HUKP-0101-03**

Straight design lever handle in solid bar stainless steel. Ball bearing concealed fixed rose with 4 point back to back fixing. Unsprung, for use with heavy duty followers. 52mm Ø and 4mm thick rose, 38mm c.c. for bolt through fixings. To suit door thickness from 35-54mm

Manufactured to BS EN1906: 2012 Class code: 4/7/-/1/1/4/0/U
316L Grade Stainless Steel for use in corrosive environments
Suitable for high frequency of use EN4
EN1634-1:2000 suitable for use on fire resisting doors



Colours shown above correspond to finishes A - Page 9

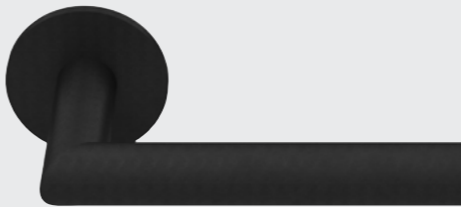

MITRED LEVER HANDLE 316 STAINLESS STEEL 19MM

PROJECT CODE: **HUKP-0101-06**

Mitred design lever handle in solid bar stainless steel. Ball bearing concealed fixed rose with 4 point back to back fixing. Unsprung, for use with heavy duty followers. 52mm Ø and 4mm thick rose, 38mm c.c. for bolt through fixings. To suit door thickness from 35-54mm

Manufactured to BS EN1906: 2012 Class code: 4/7/-/1/1/4/0/U
316L Grade Stainless Steel for use in corrosive environments
Suitable for high frequency of use EN4
EN1634-1:2000 suitable for use on fire resisting doors



Colours shown above correspond to finishes A - Page 9



HALF RADIUS LEVER HANDLE 316 STAINLESS STEEL 12 X 135MM

PROJECT CODE: **HUKP-0101-11**

Half Moon design lever handle in solid bar stainless steel. Ball bearing concealed fixed rose with 4 point back to back fixing. Unsprung, for use with heavy duty followers. 52mm Ø and 4mm thick rose, 38mm c.c. for bolt through fixings. To suit door thickness from 35-54mm

Manufactured to BS EN1906: 2012 Class code: 4/7/-/1/1/4/0/U
316L Grade Stainless Steel for use in corrosive environments
Suitable for high frequency of use EN4
EN1634-1:2000 suitable for use on fire resisting doors



Colours shown above correspond to finishes A - Page 9

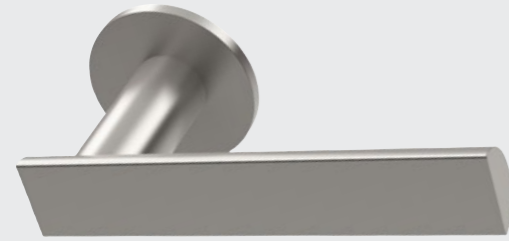

KNURLED LEVER HANDLE 316 STAINLESS STEEL 19MM

PROJECT CODE: **HUKP-0101-19**

Knurled design lever handle in solid bar stainless steel. Ball bearing concealed fixed rose with 4 point back to back fixing. Unsprung, for use with heavy duty followers. 52mm Ø and 4mm thick rose, 38mm c.c. for bolt through fixings. To suit door thickness from 35-54mm

Manufactured to BS EN1906: 2012 Class code: 4/7/-/1/1/4/0/U
316L Grade Stainless Steel for use in corrosive environments
Suitable for high frequency of use EN4
EN1634-1:2000 suitable for use on fire resisting doors



Colours shown above correspond to finishes A - Page 9

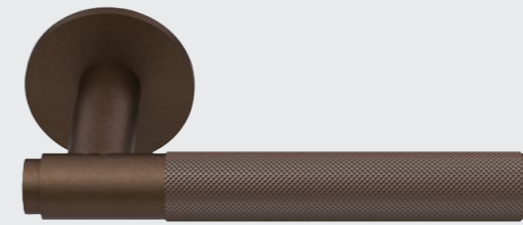

FLAT LEVER HANDLE 316 STAINLESS STEEL 6 X 135MM

PROJECT CODE: **HUKP-0101-13**

Flat design lever handle in solid bar stainless steel. Ball bearing concealed fixed rose with 4 point back to back fixing. Unsprung, for use with heavy duty followers. 52mm Ø and 4mm thick rose, 38mm c.c. for bolt through fixings. To suit door thickness from 35-54mm

Manufactured to BS EN1906: 2012 Class code: 4/7/-/1/1/4/0/U
316L Grade Stainless Steel for use in corrosive environments
Suitable for high frequency of use EN4
EN1634-1:2000 suitable for use on fire resisting doors



Colours shown above correspond to finishes A - Page 9



WEDGE LEVER HANDLE 316 STAINLESS STEEL 22 X 130MM

PROJECT CODE: **HUKP-0101-21**

Wedge design lever handle in solid bar stainless steel. Ball bearing concealed fixed rose with 4 point back to back fixing. Unsprung, for use with heavy duty followers. 52mm Ø and 4mm thick rose, 38mm c.c. for bolt through fixings. To suit door thickness from 35-54mm

Manufactured to BS EN1906: 2012 Class code: 4/7/-/1/1/4/0/U
316L Grade Stainless Steel for use in corrosive environments
Suitable for high frequency of use EN4
EN1634-1:2000 suitable for use on fire resisting doors



Colours shown above correspond to finishes A - Page 9



WEDGE LEVER HANDLE SHOT-BLASTED SILVER 22 X 130MM

PROJECT CODE: **HUKP-0101-24**

Wedge design lever handle in stainless steel shot-blasted. Ball bearing concealed fixed rose with 4 point back to back fixing. Unsprung, for use with heavy duty followers. 52mm Ø and 4mm thick rose, 38mm c.c. for bolt through fixings. To suit door thickness from 35-54mm

Manufactured to BS EN1906: 2012 Class code: 4/7/-/1/1/4/0/U
316L Grade Stainless Steel for use in corrosive environments
Suitable for high frequency of use EN4
EN1634-1:2000 suitable for use on fire resisting doors



Colours shown above correspond to finishes A - Page 9

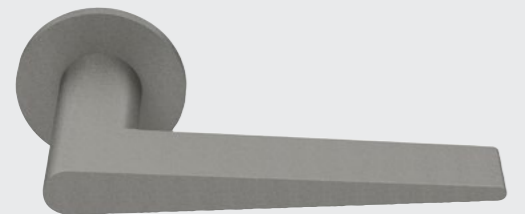

TAPERED LEVER HANDLE 316 STAINLESS STEEL 20 X 145MM

PROJECT CODE: **HUKP-0101-16**

Tapered design lever handle in solid bar stainless steel. Ball bearing concealed fixed rose with 4 point back to back fixing. Unsprung, for use with heavy duty followers. 52mm Ø and 4mm thick rose, 38mm c.c. for bolt through fixings. To suit door thickness from 35-54mm

Manufactured to BS EN1906: 2012 Class code: 4/7/-/1/1/4/0/U
316L Grade Stainless Steel for use in corrosive environments
Suitable for high frequency of use EN4
EN1634-1:2000 suitable for use on fire resisting doors



Colours shown above correspond to finishes A - Page 9





CURVED LEVER HANDLE 316 STAINLESS STEEL

PROJECT CODE: **HUKP-0101-29**

Curved design lever handle in solid stainless steel. Ball bearing concealed fixed rose with 4 point back to back fixing. Unsprung, for use with heavy duty followers. 52mm Ø and 4mm thick rose, 38mm c.c. for bolt through fixings. To suit door thickness from 35-54mm

Manufactured to BS EN1906: 2012 Class code: 4/7/-/1/1/4/0/U
316L Grade Stainless Steel for use in corrosive environments
Suitable for high frequency of use
EN1634-1:2000 suitable for use on fire resisting doors



Colours shown above correspond to finishes A - Page 9



FLAT LEVER HANDLE STAINLESS STEEL 316 GRADE

PROJECT CODE: **HUK-0101-59**

Straight design lever handle in 25mm flat section. 4mm depth round rose (square design rose available on request). Ball bearing concealed fixed rose with 4 point back to back fixing. Unsprung, for use with heavy duty followers. 52mm Ø and 4mm thick rose, 38mm c.c. for bolt through fixings. To suit door thickness from 35-54mm

Manufactured to BS EN1906: 2012 Class code: 4/7/-/1/1/4/0/U
Suitable for high frequency of use
EN1634-1:2000 suitable for use on fire resisting doors



Colours shown above correspond to finishes A - Page 9

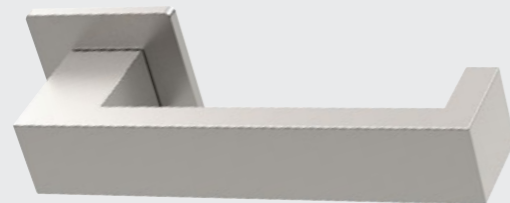

FLAT RTD LEVER HANDLE 316 STAINLESS STEEL

PROJECT CODE: **HUKP-0101-31**

"L" Shape Return to Door lever handle in solid stainless steel. Ball bearing concealed fixed rose with 4 point back to back fixing. Unsprung, for use with heavy duty followers. 52mm Ø and 4mm thick rose, 38mm c.c. for bolt through fixings. To suit door thickness from 35-54mm

Manufactured to BS EN1906: 2012 Class code: 4/7/-/1/1/4/0/U
316L Grade Stainless Steel for use in corrosive environments
Suitable for high frequency of use EN4
EN1634-1:2000 suitable for use on fire resisting doors



Colours shown above correspond to finishes A - Page 9



SQUARE LEVER HANDLE 316 STAINLESS STEEL 20MM

PROJECT CODE: **HUKP-0101-41**

Square section design lever handle in solid bar stainless steel. Ball bearing concealed fixed rose with 4 point back to back fixing. Unsprung, square rose for use with heavy duty followers. 52mm Sq. and 4mm thick rose, 38mm c.c. for bolt through fixings. To suit door thickness from 35-54mm

Manufactured to BS EN1906: 2012 Class code: 4/7/-/1/1/4/0/U
316L Grade Stainless Steel for use in corrosive environments
Suitable for high frequency of use
EN1634-1:2000 suitable for use on fire resisting doors



Colours shown above correspond to finishes A - Page 9

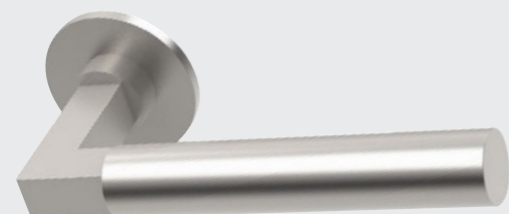

LEVER HANDLE ON ROSE 316 STAINLESS STEEL 22MM

PROJECT CODE: **HUKP-0101-62**

22mm Ø designer lever handle in solid bar stainless steel. Square elbow 15 x 15mm. Concealed bush fixing rose. Unsprung, for use with heavy duty followers. 52mm Ø and 4mm thick rose, 38mm c.c. for bolt through fixings. To suit door thickness from 35-54mm

Manufactured to BS EN1906: 2012 Class code: 4/7/-/1/1/4/0/U
316L Grade Stainless Steel for use in corrosive environments
Suitable for high frequency of use
EN1634-1:2000 suitable for use on fire resisting doors



Colours shown above correspond to finishes A - Page 9



SOFT-TOUCH LEVER HANDLE 316 STAINLESS / EPOXY RESIN

PROJECT CODE: **HUKP-0101-25**

Dual finish straight lever in stainless steel / soft-touch epoxy resin. Ball bearing concealed fixed rose with 4 point back to back fixing. Unsprung, for use with heavy duty followers. 52mm Ø and 4mm thick rose, 38mm c.c. for bolt through fixings. To suit door thickness from 35-54mm

Manufactured to BS EN1906: 2012 Class code: 4/7/-/1/1/4/0/U
316L Grade Stainless Steel for use in corrosive environments
Suitable for high frequency use and consideration for warm touch
EN1634-1:2000 suitable for use on fire resisting doors



Colours shown above correspond to finishes A - Page 9





FINISHES - B

Häfele is a proud distributor of the FSB range of door furniture which is manufactured in Grade 304 Stainless Steel, Aluminium & Real Bronze materials. Designs are available as Polished or Satin Stainless Steel, Aluminium based material in Satin Anodised or Shot-Blasted in a variety of finishes*, and finally Real Bronze which in Light Patinated or Dark Oxidized finishes.



Satin
Stainless Steel



Polished
Stainless Steel



Satin
Anodised



RAL Colour



Light
Bronze



Medium
Bronze*

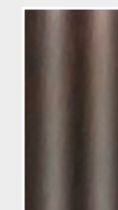

Dark
Bronze*

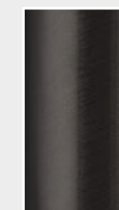

Matt Black*



*Aluminium Shot-Blasted finish

Real Bronze

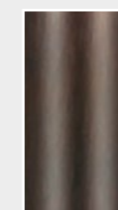

Dark
Bronze*

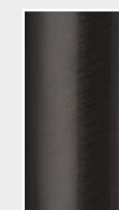

Matt Black*



FSB 1021 LEVER HANDLE

PROJECT CODE: **HUKP-0401-01**

Design: Hartmut Weise version of classic Bauhaus design. ASL® sprung adapter-system with inseparable sliding bearings. M5 Stainless bolts and lugs for secure bolt through fixing. Suitable for 39-58mm door thickness (other thicknesses available). Other back plate options available.

EN1906: 2012 Classification code 4/7/-/0/1/4/0/A
EN1634-1 suitable for use on fire resisting doors



Colours shown above correspond to finishes B - Page 17



FSB 1051 LEVER HANDLE

PROJECT CODE: **HUKP-0401-21**

Design: Johannes Potente - the sleek "Schneider Handle". Square section dimension: 21x21mm grip cross section. ASL® sprung adapter-system with inseparable sliding bearings. M5 Stainless bolts and lugs for secure bolt through fixing. Suitable for 39-58mm door thickness (other thicknesses available). Other back plate options available.

EN1906: 2012 Classification code 4/7/-/0/1/4/0/A
EN1634-1 suitable for use on fire resisting doors



Colours shown above correspond to finishes B - Page 17



FSB 1144 LEVER HANDLE

PROJECT CODE: **HUKP-0401-02**

Design: Jasper Morrison modern spoon-shaped design. ASL® sprung adapter-system with inseparable sliding bearings. M5 Stainless bolts and lugs for secure bolt through fixing. Suitable for 39-58mm door thickness (other thicknesses available). Other back plate options available.

EN1906: 2012 Classification code 4/7/-/0/1/4/0/A
EN1634-1 suitable for use on fire resisting doors



Colours shown above correspond to finishes B - Page 17



FSB 1001 LEVER HANDLE

PROJECT CODE: **HUKP-0401-09**

Design: Peter Bastian - a square lever for large-format doors. Square section dimension: 21x21mm grip cross section. ASL® sprung adapter-system with inseparable sliding bearings. M5 Stainless bolts and lugs for secure bolt through fixing. Suitable for 39-58mm door thickness (other thicknesses available). Other back plate options available.

EN1906: 2012 Classification code 4/7/-/0/1/4/0/A
EN1634-1 suitable for use on fire resisting doors



Colours shown above correspond to finishes B - Page 17



FSB 1023 LEVER HANDLE

PROJECT CODE: **HUKP-0401-06**

Design: Johannes Potente take on the handle by Max Bill for the Ulm Design College as alternative to U-shaped models. ASL® sprung adapter-system with inseparable sliding bearings. M5 Stainless bolts and lugs for secure bolt through fixing. Suitable for 39-58mm door thickness (other thicknesses available). Other back plate options available.

EN1906: 2012 Classification code 4/7/-/0/1/4/0/A
EN1634-1 suitable for use on fire resisting doors



Colours shown above correspond to finishes B - Page 17



FSB 1002 LEVER HANDLE

PROJECT CODE: **HUKP-0401-10**

Design: Peter Bastian - a square lever for large-format doors. Square section with return to door section : 21x21mm grip. High performance bearing rose AGL® system 9mm spindle. M5 Stainless bolts and lugs for secure bolt through fixing. Suitable for 39-48mm door thickness.

Tested to BS EN1906: 2012 Classification code 4/7/-/0/1/5/0/B
Highest grade 7 - tested to over 200,000 cycles to EN1906
AGL® rose 0° stop ensures lever handle always come to rest at the horizontal position



Colours shown above correspond to finishes B - Page 17



FSB 1003 LEVER HANDLE

PROJECT CODE: **HUKP-0401-11**

Design: Johannes Potente created design of a slim door profile. ASL® sprung adapter-system with inseparable sliding bearings. M5 Stainless bolts and lugs for secure bolt through fixing. Suitable for 39-58mm door thickness (other thicknesses available). Other back plate options available.

EN1906: 2012 Classification code 4/7/-/0/1/4/0/A
EN1634-1 suitable for use on fire resisting doors



Colours shown above correspond to finishes B - Page 17



FSB 1035 LEVER HANDLE

PROJECT CODE: **HUKP-0401-20**

Design: Heike Falkenberg - a slender grip "L" shaped lever. ASL® sprung adapter-system with inseparable sliding bearings. M5 Stainless bolts and lugs for secure bolt through fixing. Suitable for 39-58mm door thickness (other thicknesses available). Square rose - other back plate options available.

EN1906: 2012 Classification code 4/7/-/0/1/4/0/A
EN1634-1 suitable for use on fire resisting doors



Colours shown above correspond to finishes B - Page 17



FSB 1004 LEVER HANDLE

PROJECT CODE: **HUKP-0401-13**

Design: David Chipperfield lever - clean-lined for interior projects. ASL® sprung adapter-system with inseparable sliding bearings. M5 Stainless bolts and lugs for secure bolt through fixing. Suitable for 39-58mm door thickness (other thicknesses available). Other back plate options available.

EN1906: 2012 Classification code 4/7/-/0/1/4/0/A
EN1634-1 suitable for use on fire resisting doors



Colours shown above correspond to finishes B - Page 17



FSB 1106 LEVER HANDLE

PROJECT CODE: **HUKP-0401-27**

Design: Christoph Mäckler "L" shape lever with indent on neck. ASL® sprung adapter-system with inseparable sliding bearings. M5 Stainless bolts and lugs for secure bolt through fixing. Suitable for 39-58mm door thickness (other thicknesses available). Other back plate options available.

EN1906: 2012 Classification code 4/7/-/0/1/4/0/A
EN1634-1 suitable for use on fire resisting doors



Colours shown above correspond to finishes B - Page 17



FSB 1015 LEVER HANDLE

PROJECT CODE: **HUKP-0401-15**

Design: Johannes Potente - visible indent for a more positive grip. ASL® sprung adapter-system with inseparable sliding bearings. M5 Stainless bolts and lugs for secure bolt through fixing. Suitable for 39-58mm door thickness (other thicknesses available). Other back plate options available.

EN1906: 2012 Classification code 4/7/-/0/1/4/0/A
EN1634-1 suitable for use on fire resisting doors



Colours shown above correspond to finishes B - Page 17



FSB 1102 LEVER HANDLE

PROJECT CODE: **HUKP-0401-26**

Design: Alessandro Mendini redesign of the iconic Gropius lever. ASL® sprung adapter-system with inseparable sliding bearings. M5 Stainless bolts and lugs for secure bolt through fixing. Suitable for 39-58mm door thickness (other thicknesses available). Other back plate options available.

EN1906: 2012 Classification code 4/7/-/0/1/4/0/A
EN1634-1 suitable for use on fire resisting doors



Colours shown above correspond to finishes B - Page 17

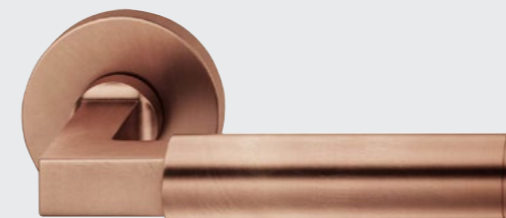



FINISHES - C

Häfele is a proud distributor of Italian design Manital door furniture, manufactured in Solid Brass, available in a wide choice of contemporary finishes including Polished Chrome, Satin Nickel and Anthracite, as well as traditional Polished and Satin Brass finishes. The No Hand lever handle is constructed in Grade 304 Stainless Steel, and is available in a variety of finishes including: Satin, Polished and Powder Coated White or Black and also Copper CU+ tube* available in Polished and Satin finishes.



Polished Chrome

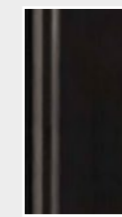

Matt Black



Satin Chrome



Anthracite

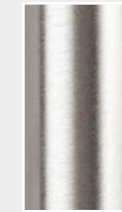

Satin Nickel



Satin Brass



Satin Stainless Steel†



Polished Stainless Steel†



Satin Copper††



Polished Copper††



White Powder Coat



*Copper tube version (CU+) known for natural anti-microbial properties that protect. Minimum production only on application.

†Stainless and Copper finishes refer to no-lever handles only

LEVER HANDLE SPRUNG, ON ROUND ROSE

PROJECT CODE: **HUKP-0501-01**

Modern design lever handle pivot fitted into rose. Designer Maurizio Giordano and Roberto Grossi. Sprung, for use with standard duty followers. 50mm Ø and 10mm thick rose, tested to over 200,000 cycles.

Manufactured to BS EN1906: 2012 Class code: 3/7/-/0/0/5/0/B
Roses pierced at 38mm c.c for M4 Bolt through fixing
To suit door thickness from 38-50mm



Colours shown above correspond to finishes C - Page 23

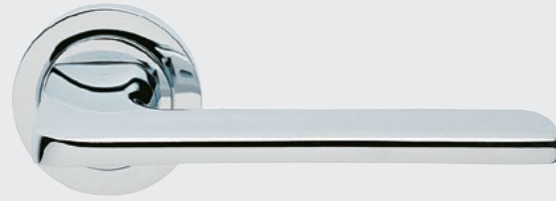

LEVER HANDLE SPRUNG, ON ROUND ROSE

PROJECT CODE: **HUKP-0501-05**

Modern design lever handle pivot fitted into a round rose. Designer: Mario Mazzer. Sprung, for use with standard duty followers. 50mm Ø and 10mm thick rose, tested to over 200,000 cycles

Manufactured to BS EN1906: 2012 Class code: 3/7/-/0/0/5/0/B
Roses pierced at 38mm c.c for M4 Bolt through fixing
To suit door thickness from 38-50mm



Colours shown above correspond to finishes C - Page 23



LEVER HANDLE SPRUNG, ON SQUARE ROSE

PROJECT CODE: **HUKP-0501-02**

Modern design lever handle pivot fitted into a square rose. Designer: Maurizio Giordano. Sprung, for use with standard duty followers. 50mm Sq, and 10mm thick rose, tested to over 200,000 cycles.

Manufactured to BS EN1906: 2012 Class code: 3/7/-/0/0/5/0/B
Roses pierced at 38mm c.c for M4 Bolt through fixing
To suit door thickness from 38-50mm



Colours shown above correspond to finishes C - Page 23

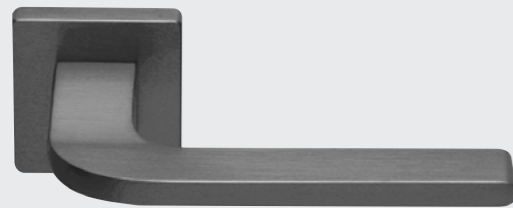

LEVER HANDLE SPRUNG, ON ROUND ROSE

PROJECT CODE: **HUKP-0501-07**

Modern design lever handle pivot fitted into a round rose. Designer: Mario Mazzer and Giovanni Crosera. Sprung, for use with standard duty followers. 50mm Ø and 10mm thick rose, tested to over 200,000 cycles.

Manufactured to BS EN1906: 2012 Class code: 3/7/-/0/0/5/0/B
Roses pierced at 38mm c.c for M4 Bolt through fixing
To suit door thickness from 38-50mm



Colours shown above correspond to finishes C - Page 23

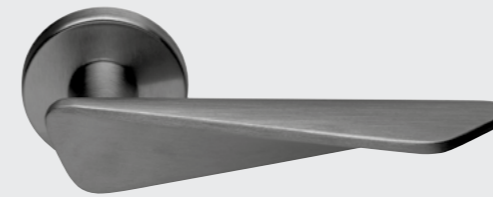

LEVER HANDLE SPRUNG, ON SQUARE ROSE

PROJECT CODE: **HUKP-0501-04**

Modern design lever handle pivot fitted into a square rose. Designer: Mario Mazzer. Sprung, for use with standard duty followers. 50mm Sq, and 10mm thick rose, tested to over 200,000 cycles

Manufactured to BS EN1906: 2012 Class code: 3/7/-/0/0/5/0/B
Roses pierced at 38mm c.c for M4 Bolt through fixing
To suit door thickness from 38-50mm



Colours shown above correspond to finishes C - Page 23



LEVER HANDLE SPRUNG, ON ROUND ROSE

PROJECT CODE: **HUKP-0501-07**

Modern design lever handle pivot fitted into a round rose. Designer: Mario Mazzer and Giovanni Crosera. Sprung, for use with standard duty followers. 50mm Ø and 10mm thick rose, tested to over 200,000 cycles.

Manufactured to BS EN1906: 2012 Class code: 3/7/-/0/0/5/0/B
Roses pierced at 38mm c.c for M4 Bolt through fixing
To suit door thickness from 38-50mm



Colours shown above correspond to finishes C - Page 23



NO-HAND LEVER HANDLE SPRUNG, 304 STAINLESS STEEL

PROJECT CODE: **HUKP-0501-09**

Barrier-free lever handle set for opening doors with forearm. Designer: Mario Mazzer and Giovanni Crosera. Sprung, for use with standard duty followers. Lever length 192mm and 82mm projection. 52mm Ø and 8mm thick rose, tested to over 200,000 cycles.

Manufactured to BS EN1906: 2012 Class code: 3/7/-/0/0/5/0/B
Roses pierced at 38mm c.c for M4 Bolt through fixing
To suit door thickness from 38-50mm



Colours shown above correspond to finishes C - Page 23



SHORTLIST
2020



NO-HAND WC HANDLE SET SPRUNG, 304 STAINLESS STEEL

PROJECT CODE: **HUKP-0501-10**

Barrier-free Bathroom handle set for opening doors with forearm. Designer: Mario Mazzer and Giovanni Crosera. Sprung, for use with standard duty followers. Lever length 192mm and 82mm projection. 52mm Ø and 8mm thick rose, tested to over 200,000 cycles.

Manufactured to BS EN1906: 2012 Class code: 3/7/-/0/0/5/0/B
Roses pierced at 38mm c.c for M4 Bolt through fixing
To suit door thickness from 38-50mm



Colours shown above correspond to finishes C - Page 23



NO-HAND WC HANDLE SET SPRUNG, 304 STAINLESS STEEL

PROJECT CODE: **HUKP-0501-10**

Barrier-free Bathroom handle set for opening doors with forearm. Designer: Mario Mazzer and Giovanni Crosera. Sprung, for use with standard duty followers. Lever length 192mm and 82mm projection. 52mm Ø and 8mm thick rose, tested to over 200,000 cycles.

Manufactured to BS EN1906: 2012 Class code: 3/7/-/0/0/5/0/B
Roses pierced at 38mm c.c for M4 Bolt through fixing
To suit door thickness from 38-50mm



Colours shown above correspond to finishes C - Page 23

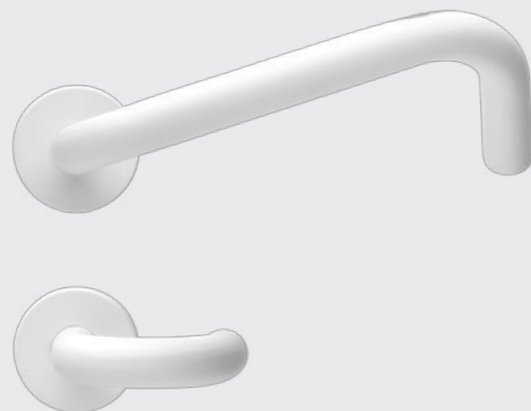

The **patented model** is destined to improve safety thanks to an innovative movement: the elbow and forearm are now the body parts delegated to the function of opening and closing doors in order from contamination of dangerous bacteria and viruses.

The handle is constructed in type **304 Stainless Steel**, and is available in a variety of finishes including: satin, polished and powder coated white or black.

NoHAND is characterised by a cylinder and an upward curve that facilitates the opening of doors with the elbow or forearm: a simple and modern design that focuses on functionality and practicality.



FINISHES - D

Häfele is a proud distributor of the Croft door furniture range. Made in England from handcrafted Solid Brass available in a wide choice of both traditional and contemporary plated finishes including Polished Chrome, Satin Nickel and Matt Black Bronze, as well as traditional finishes such as Polished Brass, Satin Brass, Autumn Bronze and Imitation Bronze Metal Antique finishes. Other finishes and patinas available to special order expertly applied in both lacquered and unlacquered finish as required.



Polished Nickel

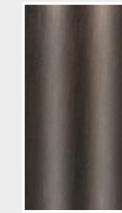

Matt Black Bronze

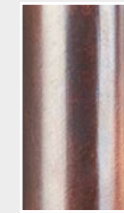

Imm. Bronze Metal Antique



Satin Brass



Polished Chrome



Polished Brass

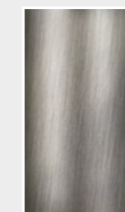

Antique Nickel

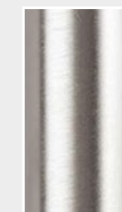

Satin Nickel



Autumn Bronze



*Other finishes available to special order



LEVER HANDLE LINEAR DESIGN SOLID BRASS

PROJECT CODE: **HUKP-0201-01**

Brass Lever on 6mm reeded sprung round concealed rose. Suitable for door thickness 44mm - 65mm as standard. Options on square rose with matching accessories.

Supplied with 8mm grooved spindle for grub screw fixing 2 wood screws and 1 Hex head c/snk screw with allen key



Colours shown above correspond to finishes D - Page 29



LEVER HANDLE BAMBOO DESIGN SOLID BRASS

PROJECT CODE: **HUKP-0201-06**

Brass Lever on 6mm plain sprung round concealed rose. Suitable for door thickness 44mm - 65mm. Options on square rose with matching accessories

Supplied with 8mm grooved spindle for grub screw fixing 2 wood screws and 1 Hex head c/snk screw with allen key



Colours shown above correspond to finishes D - Page 29



LEVER HANDLE HEXAGONAL SOLID BRASS

PROJECT CODE: **HUKP-0201-03**

Brass Lever on 6mm reeded sprung round concealed rose. Suitable for door thickness 44mm - 65mm. Options on square rose with matching accessories.

Supplied with 8mm grooved spindle for grub screw fixing 2 wood screws and 1 Hex head c/snk screw with allen key



Colours shown above correspond to finishes D - Page 29

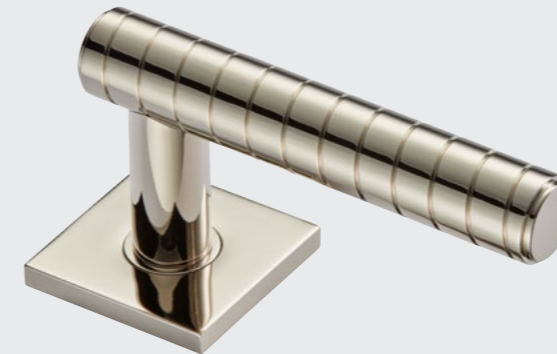

LEVER HANDLE ON SQUARE ROSE SOLID BRASS

PROJECT CODE: **HUKP-0201-28**

Brass Lever on 6mm plain sprung square concealed rose. Suitable for door thickness 44mm - 65mm. Options on round rose also available with matching accessories

Supplied with 8mm grooved spindle for grub screw fixing 2 wood screws & 1 Hex head c/snk screw with allen key



Colours shown above correspond to finishes D - Page 29



LEVER HANDLE STRAIGHT DESIGN SOLID BRASS

PROJECT CODE: **HUKP-0201-04**

Brass Lever on 6mm plain sprung round concealed rose. Suitable for door thickness 44mm - 65mm. Options on square rose with matching accessories.

Supplied with 8mm grooved spindle for grub screw fixing 2 wood screws and 1 Hex head c/snk screw with allen key



Colours shown above correspond to finishes D - Page 29



LEVER HANDLE CURVED DESIGN SOLID BRASS

PROJECT CODE: **HUKP-0201-33**

Brass Lever on 6mm plain sprung round concealed rose. Suitable for door thickness 44mm - 65mm.

Supplied with 8mm grooved spindle for grub screw fixing 2 wood screws and 1 Hex head c/snk screw with allen key



Colours shown above correspond to finishes D - Page 29



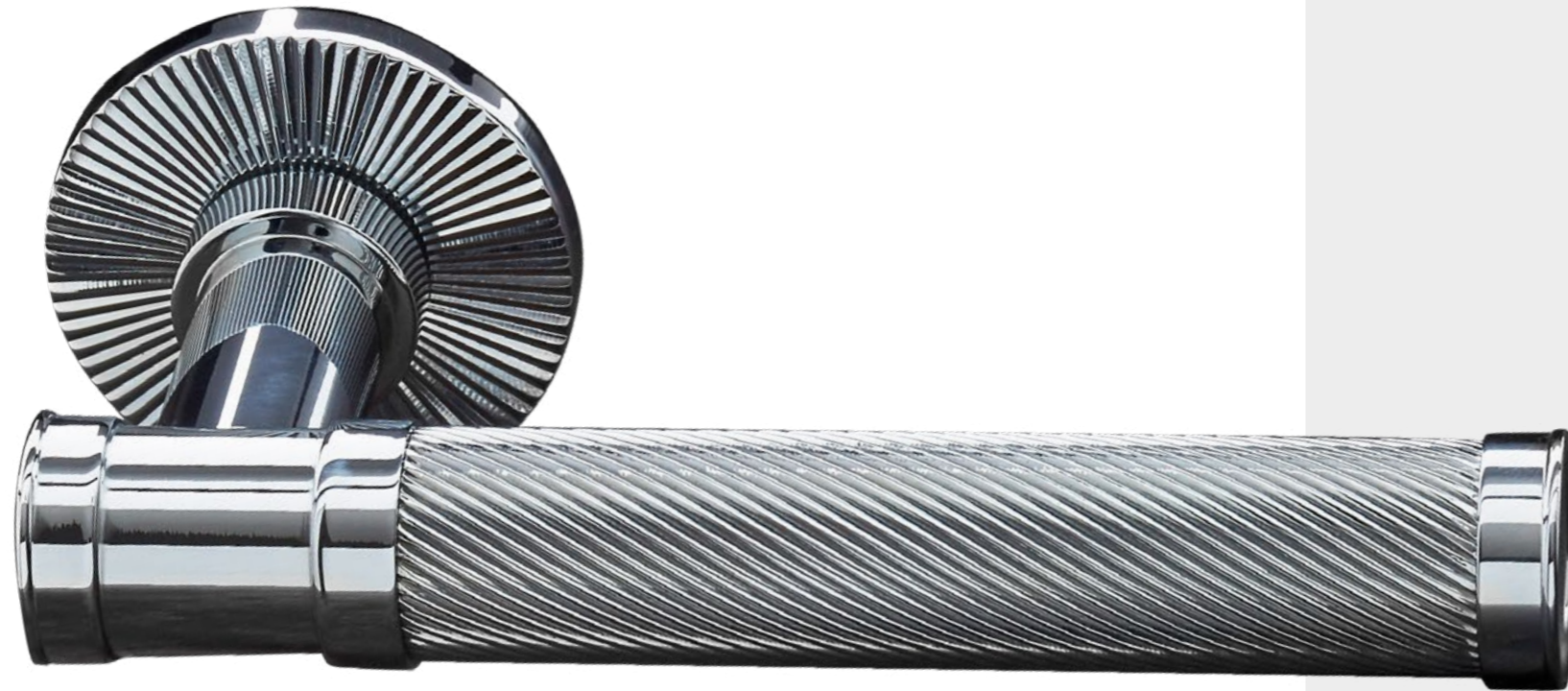

Polished
Chrome

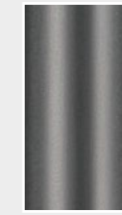

Matt Black
Nickel

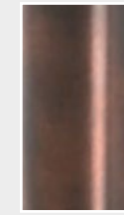

Chestnut
Bronze



Satin
Brass



Polished
Nickel

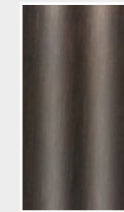

Ebony
Bronze



Satin
Copper

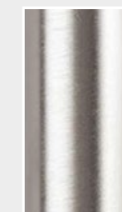

Satin
Nickel



Pearl
Nickel



FINISHES - E

Häfele is a proud distributor of the Frank Allart door furniture range. Made in England from handcrafted Solid Brass available in a wide choice of both contemporary plated finishes including Polished Chrome, Polished Nickel, Satin Copper and Matt Black Nickel, as well as traditional finishes such as Polished Brass, Satin Brass, Ebony Bronze and Chestnut Bronze finishes. Other exclusive metal finishes and patinas available to special order expertly applied in both lacquered and unlacquered finish as required.



LEVER HANDLE DIAMOND MESH SOLID BRASS

PROJECT CODE: **HUKP-0301-02**

Brass Lever on 10mm diamond mesh sprung concealed rose. Plain neck and end (options for ringed available). Standard sprung lock cases required. Suitable for door thickness 44- 57mm as standard. Options on 16mm, 19mm or 22mm Ø handle grip.

Supplied with 8mm lockpoint spindle for grub screw fixing
2 x M5 machine screws for 38mm c.c. bolt through fixing
54mm Ø rose cover screws onto spring mechanism
Options for 5mm depth sprung rose on application



Colours shown above correspond to finishes E - Page 33



LEVER HANDLE SPIRAL DESIGN SOLID BRASS

PROJECT CODE: **HUKP-0301-01**

Brass Lever on 10mm sunburst design sprung round concealed rose. Ringed neck and ring tipped design (options for plain available). Standard sprung lock cases required. Suitable for door thickness 44- 57mm as standard. Options on 16mm, 19mm or 22mm Ø handle grip.

Supplied with 8mm lockpoint spindle for grub screw fixing
2 x M5 machine screws for 38mm c.c. bolt through fixing
54mm Ø rose cover screws onto spring mechanism
Options for 5mm depth sprung rose on application



Colours shown above correspond to finishes E - Page 33



LEVER HANDLE DIAMOND KNURL SOLID BRASS

PROJECT CODE: **HUKP-0301-03**

Brass Lever on 10mm diamond knurl sprung concealed rose. Plain neck and end (options for ringed available). Standard sprung lock cases required. Suitable for door thickness 44- 57mm as standard. Options on 16mm, 19mm or 22mm Ø handle grip.

Supplied with 8mm lockpoint spindle for grub screw fixing
2 x M5 machine screws for 38mm c.c. bolt through fixing
54mm Ø rose cover screws onto spring mechanism
Options for 5mm depth sprung rose on application



Colours shown above correspond to finishes E - Page 33



LEVER HANDLE LINEAR DESIGN SOLID BRASS

PROJECT CODE: **HUKP-0301-05**

Brass Lever on 10mm linear design sprung concealed rose. Plain neck and end (options for ringed design available). Standard sprung lock cases required. Suitable for door thickness 44- 57mm as standard. Options on 16mm, 19mm or 22mm Ø handle grip.

Supplied with 8mm lockpoint spindle for grub screw fixing
2 x M5 machine screws for 38mm c.c. bolt through fixing
54mm Ø rose cover screws onto spring mechanism
Options for 5mm depth sprung rose on application



Colours shown above correspond to finishes E - Page 33



LEVER HANDLE GROOVE DESIGN SOLID BRASS

PROJECT CODE: **HUKP-0301-04**

Brass Lever on 10mm groove design sprung concealed rose. Ringed neck and end (options for plain design available). Standard sprung lock cases required. Suitable for door thickness 44- 57mm as standard. Options on 16mm, 19mm or 22mm Ø handle grip.

Supplied with 8mm lockpoint spindle for grub screw fixing
2 x M5 machine screws for 38mm c.c. bolt through fixing
54mm Ø rose cover screws onto spring mechanism
Options for 5mm depth sprung rose on application



Colours shown above correspond to finishes E - Page 33



LEVER HANDLE SMOOTH DESIGN SOLID BRASS

PROJECT CODE: **HUKP-0301-16**

Brass Lever on 10mm sprung rose Plain neck. Standard sprung lockcase required. Suitable for door thickness 44mm-57mm. options for 16mm, 19mm or 22mm Ø handle grip.

Supplied with 8mm lockpoint spindle for grub screw fixing
2 x M5 machine screws for 38mm c.c. bolt through fixing
54mm Ø rose cover screws onto spring mechanism
Options for 5mm depth sprung rose on application



Colours shown above correspond to finishes E - Page 33





PULL HANDLES

Pull handles, like lever handles, make a statement. They can deliver on functionality, finish, design & durability - equally important for any project. Full height pull handles can complete a grand entrance, or a simple pull handle can finish a corridor door. Whatever your requirements the Häfele Projects 360° curated range of pull handles, selected from leading industry manufacturers, are a perfect accompaniment to our range of lever handles.

Featured product HALF RADIUS PULL HANDLE 316 STAINLES STEEL
ON PILLARS
PROJECT CODE: HUKP-0101-12

“D” SHAPE PULL HANDLE 316 GRADE STAINLESS STEEL

PROJECT CODE: **HUKP-0101-55**

Pull handle “D” Shape design section. Hole centres standard at: 300, 425, 650, 900 and 1000mm. Diameters available: 16mm, 19mm, 25mm and 32mm. Fixing types: Bolt through, Back to Back or Secret fixing. To suit doors up to 60mm thick and glass doors 8-12mm.

Manufactured in grade 316 stainless steel



Colours shown above correspond to finishes A - Page 9



MITRED PULL HANDLE 316 STAINLESS STEEL

PROJECT CODE: **HUKP-0101-56**

Pull handle Mitred shape section. Hole centres standard at: 300, 425, 650, 900, 1000 and 1200mm. Diameters available: 19, 25, 32 and 38mm. Fixing types: Bolt through, Back to Back or Secret fixing. To suit doors up to 60mm thick and glass doors 8-12mm.

Manufactured in grade 316 stainless steel



Colours shown above correspond to finishes A - Page 9



CRANKED PULL HANDLE 316 GRADE STAINLESS STEEL

PROJECT CODE: **HUKP-0101-61**

Pull handle Cranked design section. Hole centres standard at: 300, 425, 650, 900 and 1000mm. Diameters available: 19mm, 25mm and 32mm. Fixing types: Bolt Through, Back to Back or Secret fixing. To suit doors up to 60mm thick and glass doors 8-12mm.

Manufactured in grade 316 stainless steel



Colours shown above correspond to finishes A - Page 9



HALF RADIUS PULL HANDLE 316 STAINLESS STEEL ON PILLARS

PROJECT CODE: **HUK-0101-12**

Pull handle “Half Moon” design section on pillars. Hole centres standard at: 300, 425, 600, 900 and 1000mm. Fixing types: Bolt through, Back to Back or Secret fixing. To suit doors up to 60mm thick and glass doors 8-12mm.

Manufactured in grade 316 stainless steel



Colours shown above correspond to finishes A - Page 9



GUARDSMAN PULL HANDLE 316 STAINLESS STEEL ON PILLARS

PROJECT CODE: **HUKP-0101-43**

Pull handle Guardsman design section on pillars. Hole centres standard at: 300, 425, 600, 900 and 1000mm. Diameters available: 19, 25, 32, 38, 45 and 50mm. Fixing types: Bolt through, Back to Back or Secret fixing. To suit doors up to 60mm thick and glass doors 8-12mm.

Manufactured in grade 316 stainless steel



Colours shown above correspond to finishes A - Page 9



FLAT PULL HANDLE 316 STAINLESS STEEL

PROJECT CODE: **HUKP-0101-14**

Pull handle Flat design solid section. Hole centres standard at: 300, 425, 600, 900 and 1000mm. Fixing types: Bolt through, Back to Back or Secret fixing. To suit doors up to 60mm thick and glass doors 8-12mm.

Manufactured in grade 316 stainless steel



Colours shown above correspond to finishes A - Page 9

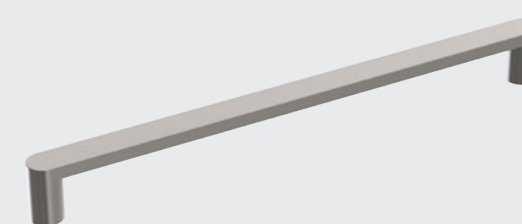

FLAT BAR PULL HANDLE 316 STAINLESS STEEL ON PILLARS

PROJECT CODE: **HUKP-0101-36**

Pull handle 25mm section flat bar design on pillars. Hole centres standard at: 300, 425, 600, 900 and 1000mm. Fixing types: Bolt through, Back to Back or Secret fixing. Available in 20mm flat section. To suit doors up to 60mm thick and glass doors 8-12mm.

Manufactured in grade 316 stainless steel



Colours shown above correspond to finishes A - Page 9



KNURLED PULL HANDLE 316 STAINLESS STEEL ON PILLARS

PROJECT CODE: **HUKP-0101-52**

Pull handle knurled design solid section on pillars. Hole centres standard at: 300, 425, 600, 900 and 1000mm. Fixing types: Bolt through, Back to Back or Secret fixing. To suit doors up to 60mm thick and glass doors 8-12mm.

Manufactured in grade 316 stainless steel



Colours shown above correspond to finishes A - Page 9



PULL HANDLE STRAIGHT 316 GRADE STAINLESS STEEL 22MM

PROJECT CODE: **HUKP-0101-63**

Straight design pull handle solid bar stainless steel section. Diameter Ø 22mm with 15 x 15mm square elbows. Lengths available 300, 425 and 600mm c.c. Lengths of mid-section: 215, 540 and 515mm respectively. Fixing types: Bolt Through, Back to Back or Secret fixing.

Manufactured in solid section st/steel round bar grade 316L
To suit doors up to 60mm thick and glass doors 8-12mm



Colours shown above correspond to finishes A - Page 9

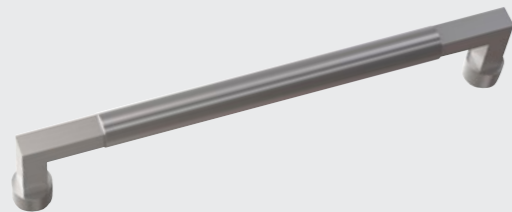

SOFT-TOUCH PULL HANDLE 316 STAINLESS / EPOXY RESIN

PROJECT CODE: **HUKP-0101-26**

Pull handle Soft-Touch straight design section on pillars. Hole centres standard at: 300, 425, 600, 900 and 1000mm. Fixing types: Bolt through, Back to Back or Secret fixing. To suit doors up to 60mm thick and glass doors 8-12mm.

Manufactured in grade 316 stainless steel and overclad in epoxy resin for a more comfortable soft touch



Colours shown above correspond to finishes A - Page 9



SQUARE PULL HANDLE 316 STAINLESS STEEL 20MM

PROJECT CODE: **HUKP-0101-42**

Pull handle in stainless steel 20mm or 25mm square section. Hole centres standard at: 300, 425, 600, 900 and 1000mm. Fixing types: Bolt through, Back to Back or Secret fixing. To suit doors up to 60mm thick and glass doors 8-12mm.

Manufactured in grade 316 stainless steel



Colours shown above correspond to finishes A - Page 9

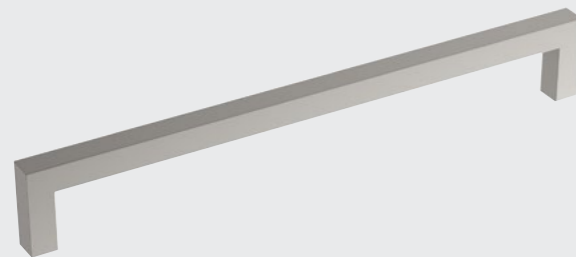

TAPERED PULL HANDLE 316 SOLID STAINLESS STEEL

PROJECT CODE: **HUKP-0101-18**

Pull handle Tapered design solid section on circular ends. Centres c.c. standard at 300, 425 and 600mm. Maximum length 1500mm. Fixing types: Bolt through, Back to Back or Secret fixing. To suit doors up to 60mm thick and glass doors 8-12mm.

Solid section stainless steel in grade 316L



Colours shown above correspond to finishes A - Page 9

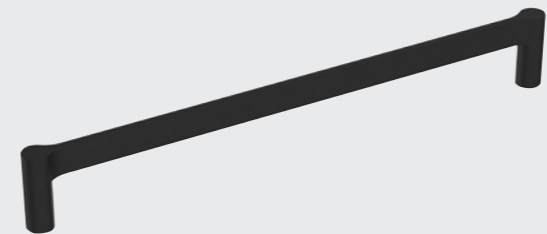



FSB 6550 PULL HANDLE

PROJECT CODE: **HUKP-0401-46**

FSB In-Line pull handle aluminium in flat design on face. Curved on back of pull for ergonomic grip. Circular stems mitred onto end of pull handle. Overall length standard: 600mm. Bolt through application shown.

Fixing types: Bolt through, Back to Back or Secret fixing
To suit doors up to 60mm thick and glass doors 8-10mm



Colours shown above correspond to finishes B - Page 17



Shown with Bolt Through fixing
* Aluminium Shot-Blasted finish



FSB 6550 PULL HANDLE

PROJECT CODE: **HUKP-0401-46**

FSB In-Line pull handle aluminium in flat design on face. Curved on back of pull for ergonomic grip. Circular stems mitred onto end of pull handle. Overall length standard: 600mm. Back to Back application shown.

Fixing types: Bolt through, Back to Back or Secret fixing
To suit doors up to 60mm thick and glass doors 8-10mm



Colours shown above correspond to finishes B - Page 17



Shown with Back to Back fixing
* Aluminium Shot-Blasted finish



FSB 6552 PULL CRANKED PULL HANDLE 450MM ALUMINIUM

PROJECT CODE: **HUKP-0401-47**

FSB Cranked pull handle in a flat design on face. Bolt through application shown. Circular stems 30mm mitred onto end of pull handle. Overall length standard: 450mm - Handed (right hand shown). Aluminium

Fixing types: Bolt through, Back to Back or Secret fixing
To suit doors up to 60mm thick and glass doors 8-10mm



Colours shown above correspond to finishes B - Page 17



Shown with Bolt Through fixing
* Aluminium Shot-Blasted finish



FSB 6552 PULL CRANKED PULL HANDLE 450MM ALUMINIUM

PROJECT CODE: **HUKP-0401-47**

FSB Cranked pull handle in a flat design on face. Back to Back application shown. Circular stems 30mm mitred onto end of pull handle. Overall length standard: 450mm - Handed (right hand shown). Aluminium

Fixing types: Bolt through, Back to Back or Secret fixing
To suit doors up to 60mm thick and glass doors 8-10mm



Colours shown above correspond to finishes B - Page 17



Shown with Back to Back fixing
* Aluminium Shot-Blasted finish



FSB 6551 PULL CRANKED PULL HANDLE 450MM ALUMINIUM

PROJECT CODE: **HUKP-0401-48**

FSB Cranked symmetrical pull handle in a flat design on face. Bolt through application shown. Circular stems 30mm mitred onto end of pull handle. Overall length standard: 450mm - Handed (right hand shown). Aluminium.

Fixing types: Bolt through, Back to Back or Secret fixing
To suit doors up to 60mm thick and glass doors 8-10mm



Colours shown above correspond to finishes B - Page 17



Shown with Bolt Through fixing
* Aluminium Shot-Blasted finish



FSB 6551 PULL CRANKED PULL HANDLE 450MM ALUMINIUM

PROJECT CODE: **HUKP-0401-48**

FSB Cranked symmetrical pull handle in a flat design on face. Bolt through application shown. Circular stems 30mm mitred onto end of pull handle. Overall length standard: 450mm - Handed (right hand shown). Aluminium.

Fixing types: Bolt through, Back to Back or Secret fixing
To suit doors up to 60mm thick and glass doors 8-10mm



Colours shown above correspond to finishes B - Page 17



Shown with Back to Back fixing
* Aluminium Shot-Blasted finish



PULLHANDLE SPIRAL DESIGN SOLID BRASS

PROJECT CODE: **HUKP-0301-11**

Brass pull handle spiral / sunburst design on 4mm roses. Ringed ends (options for plain ends and without rose available). Lengths available: 348mm, 444mm and 600mm. Options on 19mm, 22mm and 25mm Ø available.

Supplied with M8 Bolt for bolt through fixing
Options for back to back also available
44mm Ø rose with 4mm depth shown



Colours shown above correspond to finishes E - Page 33



PULLHANDLE DIAMOND MESH SOLID BRASS

PROJECT CODE: **HUKP-0301-12**

Brass pull handle diamond mesh design on 4mm depth roses. Plain ends (options for ringed ends and without rose available). Lengths available: 348mm, 444mm and 600mm. Options on 19mm, 22mm and 25mm Ø available.

Supplied with M8 Bolt for bolt through fixing
Options for back to back also available
44mm Ø rose with 4mm depth shown



Colours shown above correspond to finishes E - Page 33



PULLHANDLE SQUARE MESH SOLID BRASS

PROJECT CODE: **HUKP-0301-15**

Brass pull handle square mesh design on 4mm depth roses. Plain ends (options for ringed ends and without rose available). Lengths available: 348mm, 444mm and 600mm. Options on 19mm, 22mm and 25mm Ø available.

Supplied with M8 Bolt for bolt through fixing
Options for back to back also available
44mm Ø rose with 4mm depth shown



Colours shown above correspond to finishes E - Page 33





DOOR KNOBS

Whether you need a door knob as a decorative fixture or one to perform a function, the designs, styles and finishes on offer are varied to suit every period or look and of course budget.

Featured product MORTICE KNOBSET MODERN DESIGN SOLID BRASS
PROJECT CODE: HUKP-0201-26

MORTICE KNOBSET KNURLED SOLID BRASS

PROJECT CODE: **HUKP-0201-25**

Pair of operating knurled design mortice knobs. 64mm Ø knob and 55mm Ø rose. Two-part concealed fixing roses. Unsprung (light sprung lock case recommended).

Supplied with wood screws and M4 bolt through fixings
Supplied with special "boat" spindle secured by grub screw



Colours shown above correspond to finishes D - Page 29



MORTICE KNOBSET MODERN DESIGN SOLID BRASS

PROJECT CODE: **HUKP-0201-26**

Pair of operating modern design mortice knobs. 70mm Ø knob and 60mm Ø rose. Two-part concealed fixing roses. Unsprung (light sprung lock case recommended).

Supplied with wood screws and M4 bolt through fixings
Supplied with special "boat" spindle secured by grub screw



Colours shown above correspond to finishes D - Page 29



MORTICE KNOBSET PLAIN SOLID BRASS

PROJECT CODE: **HUKP-0201-27**

Pair of operating modern design mortice knobs. 70mm Ø knob and 60mm Ø rose. Two-part concealed fixing roses. Unsprung (light sprung lock case recommended).

Supplied with wood screws and M4 bolt through fixings
Supplied with special "boat" spindle secured by grub screw



Colours shown above correspond to finishes D - Page 29



MORTICE KNOBSET REEDED BALL SOLID BRASS

PROJECT CODE: **HUKP-0201-32**

Pair of operating mortice reeded design ball knobs. 46mm Ø knob and 57mm Ø reeded concealed rose. Two-part concealed fixing roses. Unsprung (light sprung lock case recommended).

Supplied with 3 x wood screws per rose for face fixing
Supplied with special "boat" spindle secured by grub screw



Colours shown above correspond to finishes D - Page 29



MORTICE KNOBSET BALL KNOB SOLID BRASS

PROJECT CODE: **HUKP-0201-31**

Pair of operating mortice ball knobs. 50mm Ø knob and 44mm Ø plain concealed rose. Two-part concealed fixing roses. Unsprung (light sprung lock case recommended).

Supplied with 3 x wood screws per rose for face fixing
Supplied with special "boat" spindle secured by grub screw



Colours shown above correspond to finishes D - Page 29



MORTICE KNOBSET HAMMERED SOLID BRASS

PROJECT CODE: **HUKP-0201-30**

Pair of operating hammered cushion mortice knobs. 54mm Ø knob and 57mm Ø plain concealed rose. Two-part concealed fixing roses. Unsprung (light sprung lock case recommended).

Supplied with 3 x wood screws per rose for face fixing
Supplied with special "boat" spindle secured by grub screw



Colours shown above correspond to finishes D - Page 29



FSB 0802 KNOBSET

PROJECT CODE: **HUKP-0401-40**

Door knob available in stainless steel, aluminium or bronze. Fixed dead knob option (through fix or single side fix) available. Optional backplates available. Supplied in pairs for ASL® applications. Suitable for 39-58mm door thickness.

Supplied with wood screws and M4 bolt through fixings
Supplied with special "boat" spindle secured by grub screw



Colours shown above correspond to finishes B - Page 17



FSB 0811 KNOBSET

PROJECT CODE: **HUKP-0401-43**

Door knob available in stainless steel, aluminium or bronze. Fixed dead knob option (through fix or single side fix) available. Supplied as through fixing one side or as a pair. Suitable for 39-58mm door thickness.

EN1906: 2012 Classification 4/7/-/0/1/4/0/A



Colours shown above correspond to finishes B - Page 17



FSB 0804 KNOBSET

PROJECT CODE: **HUKP-0401-41**

Knob golf club design available in stainless steel or aluminium. Fixed dead knob option (through fix or single side fix) available. Optional backplates available. Supplied in pairs for ASL® applications. Suitable for 39-58mm door thickness.

EN1906: 2012 Classification 4/7/-/0/1/4/0/A



Colours shown above correspond to finishes B - Page 17



FSB 0844 KNOBSET

PROJECT CODE: **HUKP-0401-45**

Design: Jasper Morrison. Door knob available in stainless steel, or aluminium. Fixed dead knob option (through fix or single side fix) available. Optional backplates available. Supplied in pairs for ASL® applications. Suitable for 39-58mm door thickness.

EN1906: 2012 Classification 4/7/-/0/1/4/0/A



Colours shown above correspond to finishes B - Page 17



FSB 0809 KNOBSET

PROJECT CODE: **HUKP-0401-42**

Door knob available in stainless steel, aluminium or bronze. Fixed dead knob option through fix. Supplied only as through fixing one side only. Suitable for 39-58mm door thickness.

EN1906: 2012 Classification 4/7/-/0/1/4/0/A



Colours shown above correspond to finishes B - Page 17



FSB 0828 KNOBSET

PROJECT CODE: **HUKP-0401-49**

Design: Cylindrical. Door knob available in stainless steel, or aluminium. Fixed dead knob option (through fix or single side fix) available. Optional backplates available. Supplied in pairs for ASL® applications. Suitable for 39-58mm door thickness.

EN1906: 2012 Classification 4/7/-/0/1/4/0/A



Colours shown above correspond to finishes B - Page 17





HINGES

Choosing the right product to hang your door is fundamentally important. If you have chosen the correct hardware then all other items fitted will function as intended. Doors provide a wide range of functions and you will need the perfect hinge to match your requirements, ensuring your designs operate in the way you intended for years to come.

Featured product 3 KNUCKLE BUTT HINGE CONCEALED BEARING STAINLESS STEEL
PROJECT CODE: HUKP-0202-02

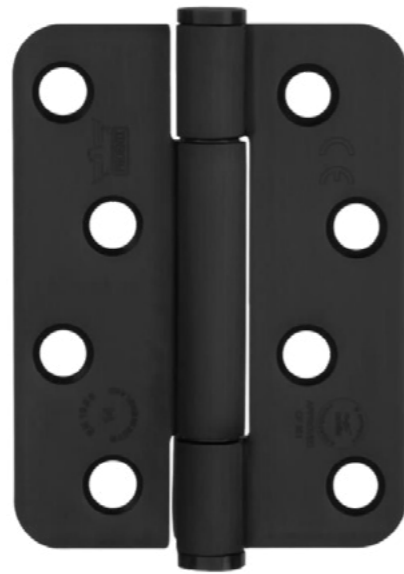

102 x 76mm in square or radius corners

3 KNUCKLE BUTT HINGE CONCEALED BEARING STAINLESS STEEL

PROJECT CODE: **HUKP-0102-02**

Concealed bearing triple knuckle butt hinge 102 x 76mm. Staggered hole pattern. EN14 maximum adjusted door weight 160kg. Square and radiused corners available. Maintenance free, low friction design. Supplied with stainless steel No.12 woodscrews/ M6 machine screws x 12mm length for metal doors.

CE marked and Certifire accredited CF 351
EN1935:2002 Classification No. 4/7/7/1/1/4/0/14
304 stainless steel (also available in 316 stainless steel)
Suitable for up to 120 min on timber doors (ITT*)
Suitable for up to 240 mins on metal doors and frames (IMM)



Colours shown above right



FINISHES

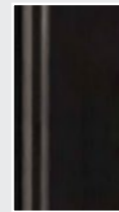

Matt Black



Polished Stainless Steel



Satin Stainless Steel



Light Bronze*

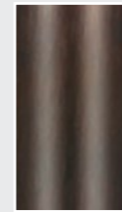

Dark Bronze*



Häfele Black



*Other finishes available to special order

HÄFELE CONCEALED BEARING HINGES

Häfele Concealed Bearing Hinges are simple and robust hinges using a fixed-pin 3-knuckle with concealed advanced polymer bushes reducing friction and providing a 25 year maintenance-free solution.

Our Concealed Bearing hinges are available in both radius and square corners as well as being independently tested to 1 million cycles and come with a 25-year guarantee suitable for quality commercial applications.



102 x 89mm in square or radius corners

3 KNUCKLE BUTT HINGE CONCEALED BEARING STAINLESS STEEL

PROJECT CODE: **HUKP-0102-01**

Concealed bearing triple knuckle butt hinge 102 x 89mm. Staggered hole pattern. EN14 maximum adjusted door weight 160kg. Square and radiused corners available. Maintenance free, low friction design. Supplied with stainless steel No.12 woodscrews / M6 machine screws x 12mm for metal doors.

CE marked and Certifire accredited CF 351
EN1935:2002 Classification No. 4/7/7/1/1/4/0/14
304 stainless steel (also available in 316 stainless steel)
Suitable for up to 120 min on timber doors (ITT*)
Suitable for up to 240 mins on metal doors and frames (IMM)



Colours shown above left



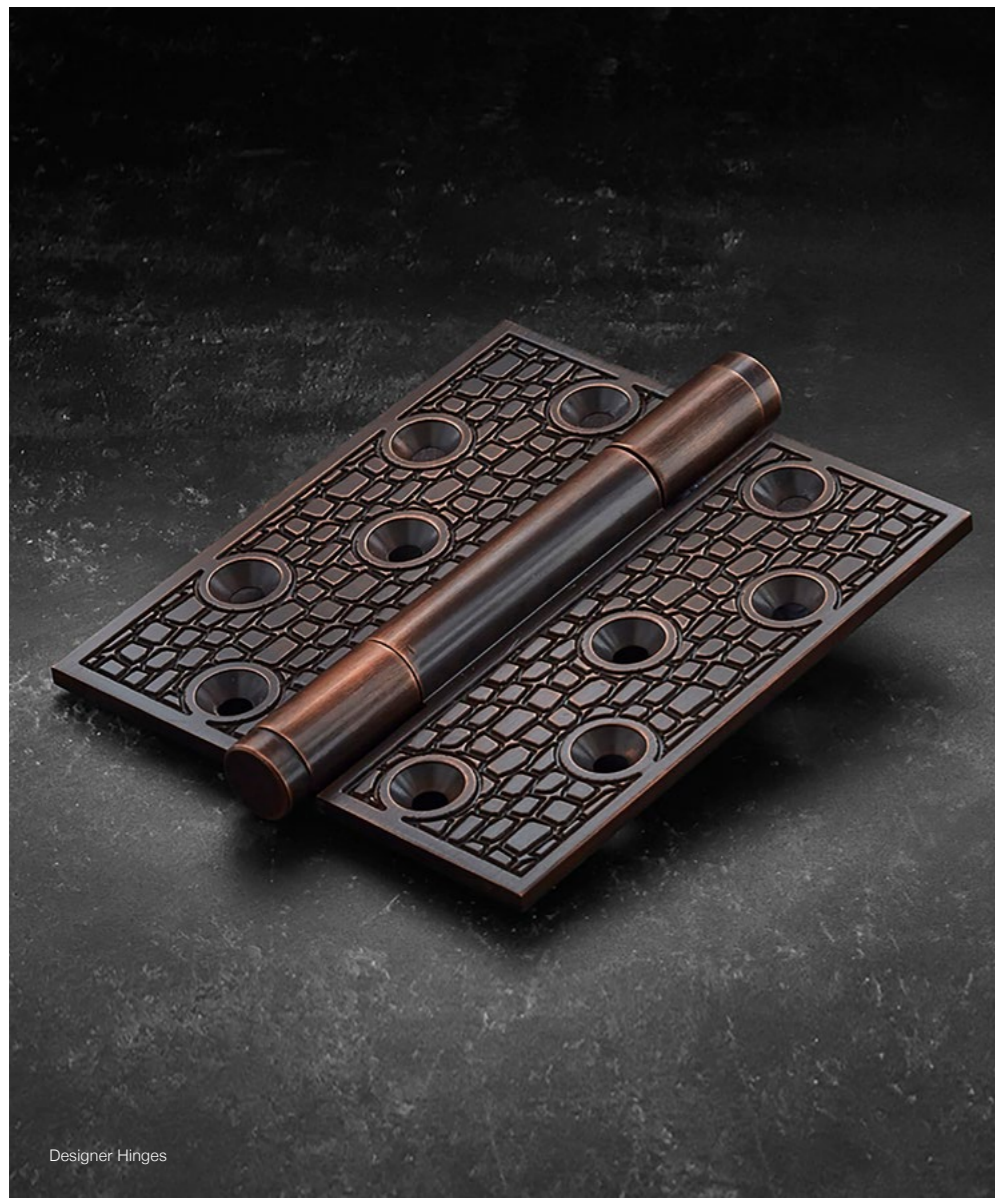

Designer Hinges

GATOR BUTT HINGE CONCEALED BEARING 100X75MM

PROJECT CODE: **HUKP-0202-07**

Brass high performance decorative concealed bearing hinge. Decorative Gator design on hinge leaves. Maximum load capacity 160 Kg - EN Grade 14. Maintenance free triple knuckle concealed bearings. Supplied complete with matching Pozi/slotted head woodscrews.

Tested to BS EN1935 Class code 4/7/7/0/1/4/0/14
Salt spray tested to over 240 hours
Maintenance Free 25-year performance guarantee



Colours shown above right



FINISHES

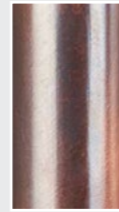

Copper
Bronze



Satin
Nickel

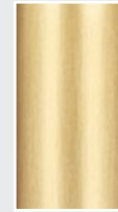

Satin
Brass

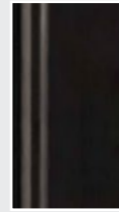

Matt Black
PVD



Polished
Chrome



Polished
Brass

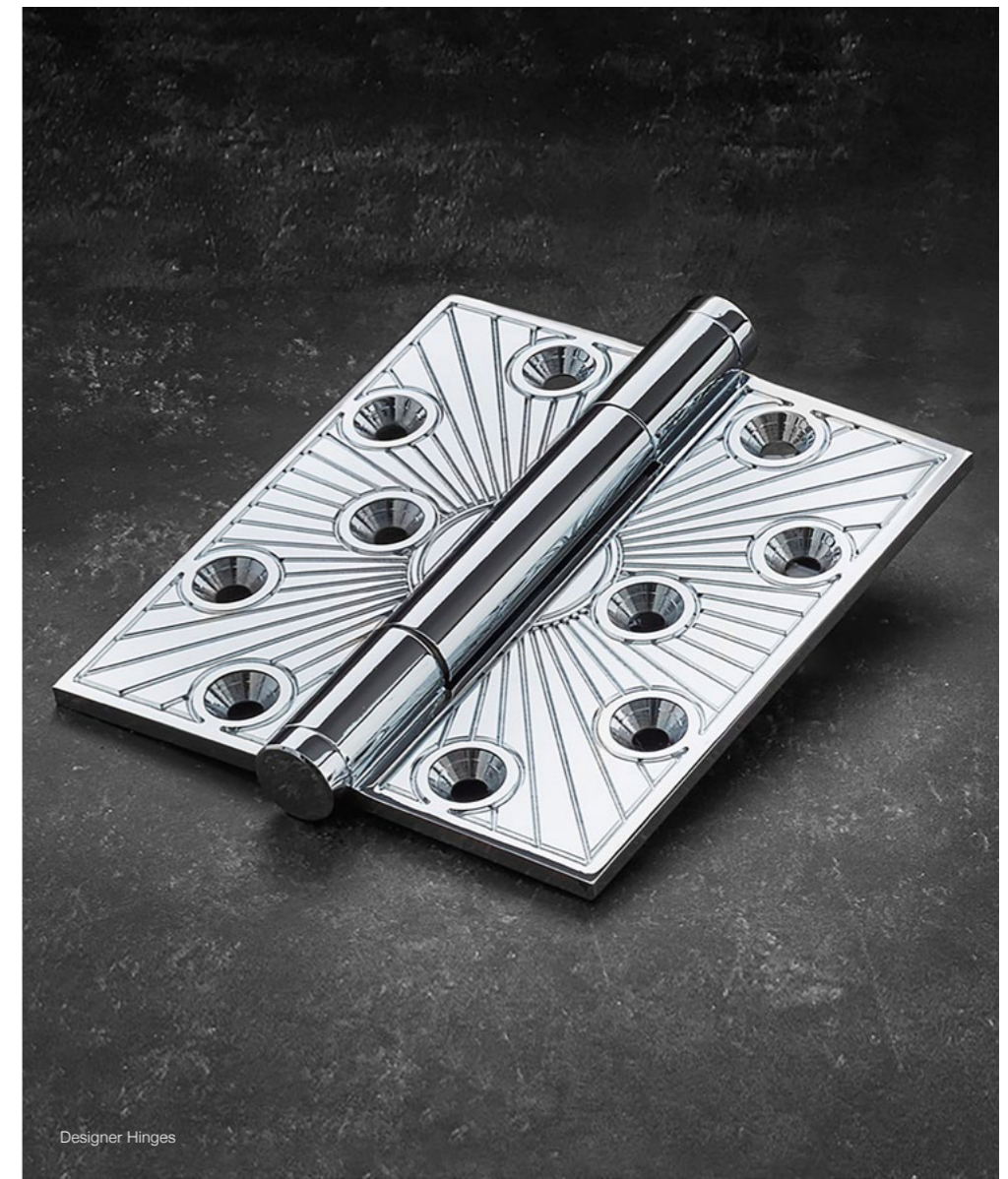

Designer Hinges

STARBURST BUTT HINGE CONCEALED BEARING 100X75MM

PROJECT CODE: **HUKP-0202-08**

Brass high performance decorative concealed bearing hinge. Decorative Starburst design on both hinge leaves. Maximum load capacity 160Kg - EN Grade 14. Maintenance free triple knuckle concealed bearings. Supplied complete with matching Pozi/slotted head woodscrews.

Tested to BS EN1935 Class code 4/7/7/0/1/4/0/14
Salt spray tested to over 240 hours
Maintenance Free 25-year performance guarantee



Colours shown above left





100 x 75 x 3.5mm

BUTT HINGE CE EN14 CONCEALED BEARING 100X75MM

PROJECT CODE: **HUKP-0202-09**

Brass high performance CE marked concealed bearing hinge. Load Capacity 160 Kg. Suitable for FD30 & FD60 fire rated applications c/w intumescent. Salt spray tested to over 1,000 hours (PVD). Complete with matching Pozi/slotted head brass woodscrews.

Tested to BS EN1935:2002 Class code 4/7/7/1/1/4/0/14
CE marked suitable for FD30 and FD60 fire rated application
Declaration of Performance DoP No.20455
Tested to BS EN1634-1 comes with Intumescent material
Maintenance Free 25-year performance guarantee



Colours shown above right



FINISHES

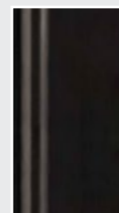

Matt Black
PVD



Satin
Nickel

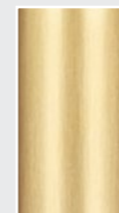

Satin
Brass



Honeycomb



Copper
Bronze



Polished
Brass



BRASS CONCEALED BEARING BUTT HINGES



100 x 88 x 3.5mm

BUTT HINGE CE EN14 CONCEALED BEARING 100 X 88MM

PROJECT CODE: **HUKP-0202-10**

Solid brass high performance concealed bearing projection hinge. Load Capacity 160Kg. Suitable for FD30 & FD60 fire rated applications c/w intumescent. Salt spray tested to over 240 hours. Complete with matching Pozi/slotted head brass woodscrews.

Tested to BS EN1935:2002 Class code 4/7/7/1/1/4/0/14
CE marked suitable for FD30 and FD60 fire rated application
Declaration of Performance DoP No. 20455
Tested to BS EN1634-1 comes with Intumescent material
Maintenance Free 25-year performance guarantee



Colours shown above left





TECTUS CONCEALED HINGES

TECTUS Concealed hinges keep the hinge fixing out of view for a subtle, refined solution. Our range is available in a selection of finishes: For access control solutions The TECTUS ENERGY range allows for permanent power transfer from frame side to door without weakening the door or frame geometry – details on request. All TECTUS “FR” variants are accredited with Certifire approval Certificate No. CF5810. [certifire](#)



FINISHES - F



Matt Black
(107)



Satin Stainless
Steel Look
(126)



Polished
Nickel
(038)



Matt
Nickel
(125)



Light
Bronze
(174)



Dark
Bronze
(176)



TECTUS TE 340 3D FR CONCEALED HINGE 160mm

PROJECT CODE: **HUKP-0202-01**

Concealed adjustable hinge. Integrated intumescent kit for un-rebated doors. Minimum door thickness 36mm. Maximum door weight 80 Kg with 180° opening angle. 3D Adjustment (side & height +/- 3.0mm compression +/- 1.0mm). Maintenance-free slide bearings for timber or aluminium frames.

WF No. 316349 suitable for use on timber FD30 fire doorsets
Approved for use on fire doors to BS EN1634-1 for FD30
Use 3 hinges for fire doors
DoP No. 2 850143 0 00000 - Class code 3/7/4/1/1*/0/11
Corrosion resistance digit* dependent on the finish
Certifire Certificate of Approval No. CF5810



certifire



Colours shown above correspond to finishes F - Page 61



TECTUS TEG 310 2D 80 ADJUSTABLE GLASS DOOR

PROJECT CODE: **HUKP-0202-06**

For flush glass doors 8-10 mm - maximum weight 80 Kg. Installation without need to drill the glass door leaf. For timber, steel or aluminium frames. Lateral side adjustment (+ 3,0/- 2,0 mm). Height adjustment (+/- 1,0 mm). Set c/w handle, closing magnet and magnetic plate (silver). Closing magnet in frame is contactless and closes silently

Using TECTUS hinge technology supports upto 80 Kg glass door
Maximum frameless glass door size approx. 2500x1300x10mm
High quality finish for residential and commercial projects



Colours shown above correspond to finishes F - Page 61



TECTUS TE 540 3D FR CONCEALED HINGE 200MM

PROJECT CODE: **HUKP-0202-02**

Concealed adjustable hinge. Integrated intumescent kit for un-rebated doors. Minimum door thickness 40mm. Maximum door weight 120 Kg with 180° opening angle. 3D Adjustment (side & height +/- 3.0mm compression +/- 1.0mm). Maintenance -free slide bearings for timber or aluminium frames.

WF No. 316349 suitable for use on timber FD30 fire doorsets
Approved for use on fire doors to BS EN1634-1 for FD30
Use 3 hinges for fire doors
DoP No. 2 850143 0 00000 - Class code 4/7/6/1/1*/1/13
Corrosion resistance digit* dependent on the finish
Certifire Certificate of Approval No. CF5810



certifire



Colours shown above correspond to finishes F - Page 61



TECTUS TE 540 3D A8 FR CONCEALED HINGE 200mm

PROJECT CODE: **HUKP-0202-04**

Concealed adjustable hinge for 8mm clearance on frame / door. Integrated intumescent kit for un-rebated doors. Min. door thickness 40mm allows for 8mm cladding both sides. Maximum door weight 100 Kg with 180° opening angle.

WF No. 316349 suitable for use on timber FD30 fire doorsets
Approved for use on fire doors to BS EN1634-1 for FD30
Use 3 hinges for fire doors
DoP No. 2 850143 0 00000 - Class code 4/7/5/1/1*/1/12
Corrosion resistance digit* dependent on the finish
Certifire Certificate of Approval No. CF5810



Colours shown above correspond to finishes F - Page 61

certifire



TECTUS TE 640 3D FR CONCEALED HINGE 240MM

PROJECT CODE: **HUKP-0202-03**

Concealed adjustable hinge. Integrated intumescent kit for un-rebated doors. Minimum door thickness 40mm. Maximum door weight 200 Kg with 180° opening angle. 3D Adjustment (side & height +/- 3.0mm compression +/- 1.0mm). Maintenance -free slide bearings for timber or aluminium frames

WF No. 316349 suitable for use on timber FD30 fire doorsets
Approved for use on fire doors to BS EN1634-1 for FD30
Use 3 hinges for fire doors
DoP No. 2 850143 0 00000 - Class code 4/7/6/1/1*/1/14
Corrosion resistance digit* dependent on the finish
Certifire Certificate of Approval No. CF5810



certifire



Colours shown above correspond to finishes F - Page 61



TECTUS TE 527 3D FD60 CONCEALED HINGE 155mm

PROJECT CODE: **HUKP-0202-05**

Concealed adjustable hinge with FD60 intumescent kit. All steel material construction. Minimum door thickness 34mm. Maximum door weight 120 Kg with 180° opening angle. 3D Adjustment (side & height +/- 3.0mm compression +/- 1.0mm). Maintenance -free slide bearings for timber or aluminium frames.

WF No.348445 suitable for use on timber FD60 fire doorsets
Approved for use on fire doors to BS EN1634-1 for FD60
Use 3 hinges for fire doors
DoP No. 2 850143 0 00000 - Class code 4/7/6/1/1*/1/13
Corrosion resistance digit* dependent on the finish
Certifire Certificate of Approval No. CF5810



Colours shown above correspond to finishes F - Page 61

certifire





CONCEALED HINGE SINGLE-AXIS STAINLESS STEEL

PROJECT CODE: **HUKP-0302-03**

Single-Axis concealed hinge - no visible knuckle when closed. Hi-Load maintenance free bearing. Maximum adjusted door weight 120 Kg. Fully adjustable 5mm vertical and 4mm horizontal adjustment. Door thickness 44 - 54mm. Maximum opening angle 110°. Stainless Steel Grade 304.

Tested to BS EN1935: Grade 13. Classification code 4/7/6/1/1/0/13
CE Certificate No. 2812-CPR-AC0007 (SS)
Suitable for FD30 & FD60 timber fire door sets to BS 476: Part 22
Intumescent pad set included for use on fire doors
8 No. Ø 4.8mm stainless steel countersunk screws included



Colours shown above correspond to finishes shown opposite - Page 65



FINISHES



Satin Stainless Steel



Polished Stainless Steel

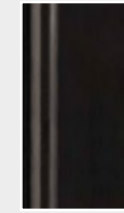

Matt Black

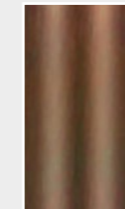

Mid Bronze*

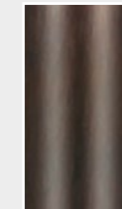

Dark Bronze*



Häfele Black



*Other finishes available to special order



RISING BUTT HINGE RIGHT HAND STAINLESS STEEL

PROJECT CODE: **HUKP-0302-01**

RH (Anti-Clockwise Closing) hinge self closes door on release. Door will rise 13.6mm over 180° (concealed cams when closed). Maximum adjusted door weight 50Kg. Radius corner hinges to R5 available on request. Minimum door thickness 29mm. Stainless Steel Grade 304.

Supplied with Metric No.5 x 32mm stainless steel woodscrews
Rising hinges are handed - see diagram below (right hand shown)
Head and frame detail require consideration to allow door to rise
Cam faces and hinge pin must be lubricated with grease supplied



Colours shown above correspond to finishes shown opposite - Page 65



RISING BUTT HINGE LEFT HAND STAINLESS STEEL

PROJECT CODE: **HUKP-0302-02**

LH (Clockwise Closing) hinge self closes door on release. Door will rise 13.6mm over 180° (concealed cams when closed). Maximum adjusted door weight 50 Kg. Radius corner hinges to R5 available on request. Minimum door thickness 29mm. Stainless Steel Grade 304.

Supplied with Metric No.5 x 32mm stainless steel woodscrews
Rising hinges are handed - see diagram below (left hand shown)
Head and frame detail require consideration to allow door to rise
Cam faces and hinge pin must be lubricated with grease supplied



Colours shown above correspond to finishes shown opposite - Page 65





DOOR CONTROLS

Our range of door closers has the functionality, design & finish for every project; whether it's fire protection or simply to add privacy. The expert advice of Häfele's Projects 360° team can help you find the right door closer to suit your project.

Featured product TS92-B CAM ACTION GUIDE RAILDOOR CLOSER EN1-4 CONTUR DESIGN
PROJECT CODE: HUKP-0304-03



FINISHES - K



Satin
Stainless Steel



Polished
Stainless Steel

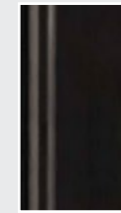

Matt
Black

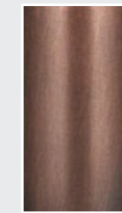

Mid
Bronze*

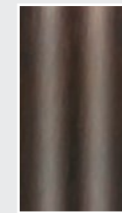

Dark
Bronze*



Häfele
Black



Polished
Brass

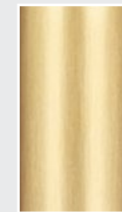

Satin
Brass



RAL
Colour*



*Other finishes available to special order



TS92-B CAM ACTION GUIDE RAIL DOOR CLOSER EN1-4 CONTUR DESIGN

PROJECT CODE: **HUKP-0304-03**

dormakaba TS92-B Cam Action Closer- Fig 1/61 Pull Side. Contur Design cover available in various finishes Suitable for door widths upto 1100mm. Suitable for left and right hand use. EN 1-4 adjustable and infinitely variable closing speed.

Tested and approved to BS EN1154:2003 Class 4/8/4-1/1/1/3
CE marked and Certifire approved CF 119
EN 1634-1 tested - suitable for upto 2 hours on timber door sets
Suitable for steel doors and frames upto 4 hours fire-resistance**
Torque curve compliance BS8300 to size EN3 (door size ≥ 767mm)



Colours shown above correspond to finishes K - Page 68



**Fully insulated steel door & frame



TS92-G CAM ACTION GUIDE RAIL DOOR CLOSER EN1-4 CONTUR DESIGN

PROJECT CODE: **HUKP-0304-04**

dormakaba TS92-G Cam Action Closer- Fig 1/61 Push Side. Contur Design cover available in various finishes. Suitable for door widths upto 1100mm. Suitable for left and right hand use. EN 1-4 adjustable and infinitely variable closing speed.

Tested and approved to BS EN1154:2003 Class 4/8/4-1/1/1/3
CE marked and Certifire approved CF 119
EN 1634-1 tested - suitable for upto 2 hours on timber door sets
Suitable for steel doors and frames upto 4 hours fire-resistance**
Torque curve compliance BS8300 to size EN3 (door size ≥ 767mm)



Colours shown above correspond to finishes K - Page 68



**Fully insulated steel door & frame



TS93-B CAM ACTION GUIDE RAIL DOOR CLOSER EN2-5 CONTUR DESIGN

PROJECT CODE: **HUKP-0304-01**

dormakaba TS93-B Cam Action Closer- Fig 1/61 Pull Side. Contur Design cover available in various finishes. Suitable for door widths upto 1250mm. Adjustable 'thinking' backcheck. Adjustable delayed action. EN 2-5 adjustable and infinitely variable closing speed

Tested and approved to BS EN1154:2003 Class 4/8/5-2/1/1/4
CE marked and Certifire approved CF 119
EN 1634-1 tested - suitable for upto 2 hours on timber door sets
Suitable for steel doors and frames upto 4 hours fire-resistance**
Torque curve compliance BS8300 to size EN3 (door size ≥ 767mm)



Colours shown above correspond to finishes K - Page 68



**Fully insulated steel door & frame



TS93-G CAM ACTION GUIDE RAIL DOOR CLOSER EN2-5 CONTUR DESIGN

PROJECT CODE: **HUKP-0304-02**

dormakaba TS93-G Cam Action Closer- Fig 1/61 Push Side. Contur Design cover available in various finishes. Suitable for door widths upto 1250mm. Adjustable 'thinking' backcheck. Adjustable delayed action. EN 2-5 adjustable and infinitely variable closing speed.

Tested and approved to BS EN1154:2003 Class 4/8/5-2/1/1/4
CE marked and Certifire approved CF 119
EN 1634-1 tested - suitable for upto 2 hours on timber door sets
Suitable for steel doors and frames upto 4 hours fire-resistance**
Torque curve compliance BS8300 to size EN3 (door size ≥ 767mm)



Colours shown above correspond to finishes K - Page 68



**Fully insulated steel door & frame



TS3000 V BC GUIDE RAIL DOOR CLOSER BACK CHECK EN1-4

PROJECT CODE: **HUKP-0404-03**

Closing force with variable adjustment from EN1-4. Hydraulic latching action and front adjustable back check. Closing speed can be individually adjusted. All functions can be set from the front (except for closing force). Single-action doors up to 1100 mm leaf width.

Tested and approved to BS EN1154:2003 Class 4/8/3/1/1/4
CE marked and Certifire approved CF 145
EN 1634-1 tested - suitable for upto 2 hours on timber door sets for all pull / push configurations on (hinge & opposite hinge side)
Suitable for steel doors and frames upto 4 hours fire-resistance**



Colours shown above correspond to finishes K - Page 68



**Fully insulated steel door & frame



TS5000 ECLINE GUIDE RAIL DOOR CLOSER EN3-5

PROJECT CODE: **HUKP-0404-02**

Closing force step-less between EN3-5 visual closing force display. Closing speed, closing force, integrated backcheck & latch action. Adjustments easily accesses from the front of the unit. Maximum 1250mm door width. Opening assistance integral to unit for easy opening of door leaf.

Tested and approved to BS EN1154:2003 Class 4/8/5-3/1/1/4
CE marked and Certifire approved CF 145
EN 1634-1 tested - suitable for upto 2 hours on timber door sets when closer body is door mounted on pull face and transom mounted on push face of the door
Suitable for steel doors and frames upto 4 hours fire-resistance**



Colours shown above correspond to finishes K - Page 68



**Fully insulated steel door & frame

TS5000 OVERHEAD GUIDE RAIL DOOR CLOSER EN 2-6

PROJECT CODE: **HUKP-0404-01**

Closing force step-less between EN2-6 visual closing force display. Closing speed, closing force, backcheck & latch action. Adjustments easily accesses from the front of the unit. Maximum 1100mm door width. Max door width 1400mm.

Tested and approved to BS EN1154:2003 Class 3/8/6-3/1/1/4
CE marked and Certifire approved CF 145
EN 1634-1 tested - suitable for upto 2 hours on timber door sets when closer body is door mounted on pull face and transom mounted on push face of the door
Suitable for steel doors and frames upto 4 hours fire-resistance**



Colours shown above correspond to finishes K - Page 69



**Fully insulated steel door & frame

DCL94 STARTEC GUIDE RAIL CLOSER WITH BACKCHECK EN3-6

PROJECT CODE: **HUKP-0504-01**

Guide rail door closer EN3-6 with Backcheck. B-Type for door mount pull side only. Adjustable closing speed and latch action. Adjustable backcheck. Opening angle to 180°. Maximum door width 1400mm

Tested and approved to BS EN1154:1996 Class 4/8/6-3/1/1/4
CE marked
Barrier -free in compliance with DIN 18040
EN 1634-1 tested on pull side (Fig1) only
Suitable for upto 60 minutes on timber doors



Colours shown above correspond to finishes K - Page 69



CAM ACTION DOOR CLOSER B-TYPE WITH GUIDE RAIL EN2-5

PROJECT CODE: **HUKP-0104-01**

Cam action spring adjustable door closer EN2-5 with slide arm. B-Type for door mount pull side & transom mount push side. Adjustable closing speed and latch action. Adjustable backcheck and delayed action. Min. door width 860mm to meet ADM at EN3 (800mm push side). Maximum door width 1250mm (shown with semi-radius cover).

Tested and approved to BS EN1154:1996 Class 4/8/5-3/1/1/3
CE marked and Certifire approved CF 5312
Capable of meeting opening force requirements for BS8300
EN 1634-1 tested - Suitable for upto 2 hours on timber door sets



Colours shown above correspond to finishes K - Page 69



CAM ACTION DOOR CLOSER G-TYPE WITH GUIDE RAIL EN2-5

PROJECT CODE: **HUKP-0104-02**

Cam action spring adjustable door closer EN2-5 with slide arm. G-Type for door mount push side & transom mount pull side. Adjustable closing speed and latch action. Adjustable backcheck and delayed action. Min. door width 860mm to meet ADM at EN3 (800mm push side). Maximum door width 1250mm (shown with semi-radius cover).

Tested and approved to BS EN1154:1996 Class 3/8/5-2/1/1/3
CE marked and Certifire approved CF 5312
Capable of meeting opening force requirements for BS8300
EN 1634-1 tested - Suitable for upto 2 hours on timber door sets



Colours shown above correspond to finishes K - Page 69



SLIMLINE CAM ACTION GUIDE RAIL DOOR CLOSER EN2-4

PROJECT CODE: **HUKP-0204-02**

Cam action closer with high efficiency for doors with high use. Power adjustable by spring, closing speed and latch action. Maximum opening angle 110° - single action Power size EN2-4. Maximum door weight 80Kg. Maximum door width 1100mm. Slimline design shown with satin stainless semi-radius cover.

Tested and approved to BS EN1154:2003 Class 3/8/4-2/1/1/3
CE marked and Certifire approved CF 5783 for Figure 1 only
Meets requirements for Approved Document M and BS830EN 1634-1 tested -
Suitable for upto 2 hours on timber door sets
Not suitable for steel doors and frames



Colours shown above correspond to finishes K - Page 69



GUIDE RAIL OVERHEAD DOOR CLOSER EN2-4

PROJECT CODE: **HUKP-0204-03**

Variable rack and pinion power closer for high use traffic. Slimline design (shown with with semi-radius cover). Power adjustable closing speed, backstop and latch action. Max opening angle 110° - single action. Power size EN2-4 (Pull side) EN3-4 (Push side). Maximum door weight 80Kg. Maximum door width 1100mm.

Tested in Fig. 1 (Pull) to BS EN1154:2003 Class 3/8/4-2/1/1/3
Tested in Fig.61 (Push) to BS EN1154:2003 Class 3/8/3-2/1/1/3
CE marked and Certifire approved CF 689 for Figure 1 + 61 only
EN 1634-1 tested - Suitable for upto 2 hours on timber door sets
Not Suitable for steel doors and frames



Colours shown above correspond to finishes K - Page 69





TS2000 NV BC OVERHEAD DOOR CLOSER WITH BACKCHECK EN2-4

PROJECT CODE: **HUKP-0404-07**

Closing force with variable step-less adjustment from EN2-4. Back-check function slows door down when door opened quickly. Hydraulic latching action accelerates door on final closing position. Shown with optional satin stainless steel semi radius cover/armset.

Tested and approved to BS EN1154:2003 Class 4/8/4-3/1/1/4
CE marked and Certifire approved CF 252
EN 1634-1 tested - suitable for upto 2 hours on timber door sets for all pull / push configurations on (hinge & opposite hinge side) when set to EN 3-4
Suitable for steel doors and frames upto 4 hours fire-resistance**



Colours shown above correspond to finishes K - Page 69



**Fully insulated steel door & frame

StarTec



DCL51 STARTEC DOOR CLOSER WITH BACKCHECK EN2-5

PROJECT CODE: **HUKP-0504-04**

Standard "V" arm door closer with backcheck function. Adjustable closing speed, backcheck and latch action. Maximum opening angle 180°. Maximum door weight 100Kg. EN2-5. Maximum door width 1250mm.

Tested & approved to BS EN1154:1996. Fig 1. Class 4/8/5-3/1/1/3
Fig 6. Classification (parallel arm) 4/8/4-3/1/1/3
CE marked and Certifire approved CF 799
Suitable for use on timber fire doors in Fig 1 and Fig 6 only
Fig 1. closer body door mounted pull face - standard installation
Fig 6. closer body door mounted on push face (parallel arm config)
EN 1634-1 tested - suitable for upto 120 mins on timber door sets



Colours shown above correspond to finishes K - Page 69



TS4000 S OVERHEAD DOOR CLOSER WITH DELAYED ACTION EN1-6

PROJECT CODE: **HUKP-0404-04**

Closing force with variable step-less adjustment from EN1-6. Delayed Action function adjustable between 120° to 80°. Hydraulic latching action and integrated back check. All functions can be set from the front of the unit. Max 1400 mm door leaf width.

Tested and approved to BS EN1154:2003 Class 4/8/6-3/1/1/4
CE marked and Certifire approved CF 252
EN 1634-1 tested - suitable for upto 2 hours on timber door sets for all pull / push configurations on (hinge & opposite hinge side)
Suitable for steel doors and frames upto 4 hours fire-resistance**



Colours shown above correspond to finishes K - Page 69



**Fully insulated steel door & frame

StarTec



DCL55 STARTEC DOOR CLOSER WITH BACKCHECK EN2-6

PROJECT CODE: **HUKP-0504-03**

Standard "V" arm door closer with backcheck function. Adjustable closing speed, backcheck and latch action. Maximum opening angle 180°. Maximum door weight 120Kg. EN2-6. Maximum door width 1400mm.

Tested & approved to BS EN1154:1996. Fig 1. Class 4/8/6-3/1/1/3
Fig 6. Classification (parallel arm) 4/8/5-4/1/1/3
CE marked and Certifire approved CF 799
Suitable for use on timber fire doors in Fig 1 and Fig 6 only
Fig 1. closer body door mounted pull face - standard installation
Fig 6. closer body door mounted on push face (parallel arm config)
EN 1634-1 tested - suitable for upto 120 mins on timber door sets



Colours shown above correspond to finishes K - Page 69



SLIMLINE DOOR CLOSER WITH BACKCHECK EN2-5

PROJECT CODE: **HUKP-0204-06**

Adjustable power rack and pinion door closer for high use traffic. Adjustable power, closing speed, backcheck and latch action. Maximum opening angle 180° - single action (pull side). Maximum door weight 100Kg. Maximum door width 1250mm. Slimline design with semi-radius cover shown.

Tested to BS EN1154:2002 Class 4/8/5-2/1/1/3 (Pull side Fig. 1)
Tested to BS EN1154:2002 Class 3/8/5-2/1/1/3 (Push side Fig 6)
CE marked and Certifire approved CF 689 for Figure 1 + 6 only
EN 1634-1 tested - Suitable for up to 2 hours on timber fire doors and up to 240 minutes on steel doors



Colours shown above correspond to finishes K - Page 69



SLIMLINE DOOR CLOSER BACKCHECK & DELAYED ACTION EN2-5

PROJECT CODE: **HUKP-0204-07**

Adjustable power rack and pinion door closer for high use traffic. Adjustable delayed action function. Maximum opening angle 180° - single action (pull side). Maximum door weight 100Kg. Maximum door width 1250mm. Slimline design with semi-radius cover shown.

Tested to BS EN1154:2002 Class 4/8/5-2/1/1/3 (Pull side Fig. 1)
Tested to BS EN1154:2002 Class 3/8/5-2/1/1/3 (Push side Fig 6)
CE marked and Certifire approved CF 689 for Figure 1 + 6 only
EN 1634-1 tested - Suitable for up to 2 hours on timber fire doors and up to 240 minutes on steel doors



Colours shown above correspond to finishes K - Page 69



ITS96 CONCEALED CAM ACTION DOOR CLOSER EN2-4

PROJECT CODE: **HUKP-0304-06**

dormakaba ITS96 Concealed Cam action for single action doors. Suitable for door widths upto 1100mm. Min 40mm thick. Closing force and latching action infinitely variable. Cam action technology for rapidly decreasing opening resistance. EN2-4 Max door opening angle approx 120° . Max door leaf 130 Kg.

Tested and approved to BS EN1154:2003 Class 3/8/4-3/1/1/4
CE marked and Certifire approved CF 140
Meets requirements for Approved Document M and BS8300
EN 1634-1 tested - suitable for upto 1 hour on timber door sets
Suitable for steel doors and frames upto 4 hours fire-resistance
Not to be fitted to timber door sets without Intumescent protection



Colours shown above correspond to finishes K - Page 68



BOXER CONCEALED CLOSER DOUBLE ACTION EN2-4

PROJECT CODE: **HUKP-0404-15**

Concealed installation into top rail of door. Double action. Maximum door weight 80 Kg. Power size EN2-4. All functions can be adjusted once installed. Latch action, closing speed and backcheck. Maximum door width 1100mm. Max opening angle 120°. Suitable for minimum door thickness 44mm

Tested and approved to BS EN1154:2003 Class 3/8/3/1/1/1
CE marked and Certifire approved CF 242
EN 1634-1 tested - suitable for upto 1 hour on timber door sets
Suitable for steel doors and frames upto 4 hours fire-resistance
Supplied with Intumescent protection kit



Colours shown above correspond to finishes K - Page 68

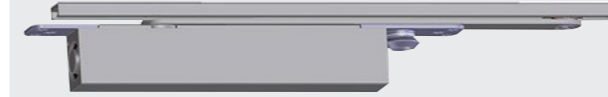

BOXER CONCEALED CLOSER SINGLE ACTION EN2-4

PROJECT CODE: **HUKP-0404-08**

Concealed installation into top rail of door. Power size EN2-4. Maximum door weight 130Kg. All functions can be adjusted once installed. Latch action, closing speed and backcheck. Maximum door width 1100mm. Max opening angle 120° Suitable for minimum door thickness 44mm

Tested and approved to BS EN1154:2003 Class 3/8/4-3/1/1/4
CE marked and Certifire approved CF 242
EN 1634-1 tested - suitable for upto 1 hour on timber door sets
Suitable for steel doors and frames upto 4 hours fire-resistance
Supplied with Intumescent protection kit



Colours shown above correspond to finishes K - Page 68



SLIMLINE CONCEALED CAM ACTION DOOR CLOSER EN2-4

PROJECT CODE: **HUKP-0204-01**

Concealed Cam action closer for installation into top rail of door. Power adjustable by spring, closing speed and latch action. Maximum opening angle 105° - single action. Power size EN2-4. Maximum door weight 80Kg. Maximum door width 1100mm. Suitable for minimum door thickness of 44mm

Tested and approved to BS EN1154:2003 Class 3/8/4-2/1/1/3
CE marked and Certifire approved CF 5783
Meets requirements for Approved Document M and BS8300
EN 1634-1 tested - suitable for upto 1 hour on timber door sets
Single action only. Not suitable for steel doors and frames
Suitable for use on timber fire doors with separate intumescent pack



Colours shown above correspond to finishes K - Page 68



BOXER CONCEALED CLOSER SINGLE ACTION EN3-6

PROJECT CODE: **HUKP-0404-09**

Concealed installation into top rail of door. Maximum door weight 180Kg. Power size EN3-6. All functions can be adjusted once installed. Latch action, closing speed and backcheck. Maximum door width 1400mm. Max opening angle 120°. Suitable for minimum door thickness 54mm

Tested and approved to BS EN1154:2003 Class 3/8/6-3/1/1/4
CE marked and Certifire approved CF 242
EN 1634-1 tested - suitable for upto 1 hour on timber door sets
Suitable for steel doors and frames upto 4 hours fire-resistance
Supplied with Intumescent protection kit



Colours shown above correspond to finishes K - Page 68



StarTec

DCL33 STARTEC CONCEALED DOOR CLOSER EN2-4

PROJECT CODE: **HUKP-0504-02**

Concealed door closer for installation into top rail of door. Power, closing speed and latch action continuously adjustable. Maximum opening angle 115° - single action. Power size EN2-4. Maximum door weight 80Kg. Maximum door width 1100mm. Suitable for minimum door thickness of 44mm

Tested and approved to BS EN1154:2003 Class 3/8/4-2/1/1/3
CE marked and Certifire approved CF 799
Meets requirements for Approved Document M and BS8300
Suitable for use on timber fire doors with separate intumescent pack
EN 1634-1 tested - suitable for upto 90 mins on timber door sets



Colours shown above correspond to finishes K - Page 68



TS99-FL FREE SWING CLOSER GUIDE RAIL EN2-5 CONTUR DESIGN

PROJECT CODE: **HUKP-0304-05**

dormakaba TS99-FL Free Swing Closer opening angle of >0°. Contur Design cover available in various finishes. Suitable for door widths upto 1250mm. EN2-5 Adjustable and infinitely variable closing speed. Mounted pull side on door leaf & transom mounted on push side only.

Tested and approved to BS EN1154:2003 Class 3/8/5-3/1/1/3
CE marked and Certifire approved CF 119
EN 1634-1 tested - suitable for upto 2 hours on timber door sets
Suitable for steel doors and frames upto 4 hours fire-resistance**
Meets requirements for Approved Document M and BS8300
Resistance-free opening in passive fire applications to EN1155



Colours shown above correspond to finishes K - Page 68



**Fully insulated steel door & frame

TS5000-EFS ELECTRO-H/OPEN FREE SWING GUIDE RAIL CLOSER EN3-6

PROJECT CODE: **HUKP-0404-14**

Closing force with variable step-less adjustment from EN3-6. Free Swing function normal swing action until fire alarm activated. Electro "Comfort -Hold -Open" feature area 85°-160° to EN1155. Comfort feature allows free swing or hold-open function all the time. Max 1400 mm door width (right & left hand doors without conversion).

Tested and approved to BS EN1154:2003 Class 3/8/5-3/1/1/4
CE marked and Certifire approved CF 145 + BS EN 1155
EN 1634-1 tested - suitable for upto 2 hours on timber door sets
for hinge / pull configuration only. Body of closer door mounted
Suitable for steel doors and frames upto 4 hours fire-resistance***



Colours shown above correspond to finishes K - Page 68



***Fully insulated steel door & frame

ELECTRO-MAGNETIC HOLD OPEN CAM ACTION DOOR CLOSER EN2-5

PROJECT CODE: **HUKP-0104-03**

24v DC Electro-magnetic cam action door closer with slide arm. Door mount pull side with electro-magnetic hold open track. Adjustable hold open point from 80° to 140°. Adjustable closing power, speed and latch action. Adjustable backcheck and delayed action functions. Maximum door width 1250mm (Min 860mm at EN3 to meet ADM).

Tested and approved to BS EN1154:1996 Class 4/8/5-2/1/1/3
Tested and approved to BS EN1155:1997 Class 3/8/5-3/1/1/3
Certifire approved CF 5312 for closer body mounted on pull side
Capable of meeting opening force requirements for BS8300
EN 1634-1 tested - Suitable for upto 2 hours on timber door sets
Door mount pull side only



Colours shown above correspond to finishes K - Page 68



ITS96-FL CONCEALED EN3-6 FREE SWING DOOR CLOSER

PROJECT CODE: **HUKP-0304-07**

dormakaba ITS96-FL Free Swing closer and guide rail. Mechanical opening angle restraint, E-Hydraulic H/open 24V DC. Suitable for door widths upto 1400mm. Min 54mm thick. Closing force and latching action infinitely variable. Cam action technology for rapidly decreasing opening resistance

Tested and approved to BS EN1154:2003 Class 3/8/6-3/1/1/4
CE marked and Certifire approved CF 140 / EN 1155
Meets requirements for Approved Document M and BS8300
EN 1634-1 tested - suitable for upto 1 hour on timber door sets
Not suitable for metal door leaves. FD30 timber doors min 54mm
Not to be fitted to timber door sets without Intumescent protection



Colours shown above correspond to finishes K - Page 68



TS4000-EFS ELECTRO-H/OPEN FREE SWING DOOR CLOSER EN1-6

PROJECT CODE: **HUKP-0404-06**

Closing force with variable step-less adjustment from EN1-6. Free Swing function normal swing action until fire alarm activated. Electro hold-open device area 80°-175° to EN1155. Adjustable hydraulic latching action. Visual closing force display for easy control of the setting. Max 1400 mm door width (right & left hand doors without conversion).

Tested and approved to BS EN1154:2003 Class 3/8/6-3/1/1/4
CE marked and Certifire approved CF 252 + BS EN 1155
EN 1634-1 tested - suitable for upto 2 hours on timber door sets
for all pull / push configurations on (hinge & opposite hinge side)**
** Figure 6 only with GEZE mounting plate 167590
Suitable for steel doors and frames upto 4 hours fire-resistance***



Colours shown above correspond to finishes K - Page 68



***Fully insulated steel door & frame

ELECTRO-MAGNETIC H/OPEN SWING FREE DOOR CLOSER EN4

PROJECT CODE: **HUKP-0204-04**

Universal hold open or Free swing E-Mag door closer, 24v DC. Slimline design (shown with semi-radius cover). Closing speed and latch action easily adjustable. Max opening angle 105° - single action. Power size EN 4. Maximum door weight 80Kg. Maximum door width 1100mm

Tested in Fig. 1 + Fig 6 to BS EN1155:1997 Class 3/8/4/1/1/3
CE marked and Certifire approved CF 5023 for Figure 1 + 6 only
EN 1634-1 tested - Suitable for upto 2 hours on timber door sets
Suitable for fully-insulated steel doors and frames upto 240 min
BS8300 - Free swing function suitable for use in applications where
ease of access is important as allows normal swing action



Colours shown above correspond to finishes K - Page 68



TS500 NV FLOOR SPRING SINGLE & DOUBLE ACTION EN1-4

PROJECT CODE: **HUKP-0404-10**

For single and double action frequently used doors. Maximum opening angle 170°. Fixed backcheck function. Closing force, speed and latch action adjustable. All functions adjustable from above after installation. Maximum door width 1100mm and 150Kg weight.

Tested and approved to BS EN1154:2003 Class 3/8/4-3/1/1/4
CE marked and Certifire approved CF 259
EN 1634-1 tested - suitable for upto 1 hour on timber door sets
Suitable for steel doors and frames upto 4 hours fire-resistance
Supplied with Intumescent protection
Suitable for both single and double action fire and smoke doors



Colours shown above correspond to finishes K - Page 68



TS550 NV F FLOOR SPRING SINGLE ACTION EN3-6

PROJECT CODE: **HUKP-0404-13**

For single action frequently used fire protection doors. Opens to and controlled from 180°. Delayed closing adjustable upto 80° opening angle. Closing force, speed and latch action adjustable. All functions adjustable from above after installation. Maximum door width 1400mm and 300Kg weight.

Tested and approved to BS EN1154:2003 Class 4/8/6-3/1/1/4
CE marked and Certifire approved CF 259 for single action only
EN 1634-1 tested - suitable for upto 1 hour on timber door sets
Suitable for steel doors and frames upto 4 hours fire-resistance
Not to be fitted to timber door sets without Intumescent protection**



Colours shown above correspond to finishes K - Page 68



** Intumescent included

TS550 NV FLOOR SPRING SINGLE & DOUBLE ACTION EN3-6

PROJECT CODE: **HUKP-0404-11**

For single & double action frequently used doors (non-fire rated). Maximum opening angle 170° in single action. Mechanical function Hold-open area 85° - 165° (switchable). Selectable Hold open & delayed action + backcheck function. Closing force, speed and latch action adjustable. All functions adjustable from above after installation. Maximum door width 1400mm and 300Kg weight.

Tested and approved to BS EN1154:2003 Class 3/8/6-3/0/1/4
Not suitable for fire doors



Colours shown above correspond to finishes K - Page 68



DOUBLE ACTION FLOOR SPRING SET WITH ACCESSORIES EN1-4

PROJECT CODE: **HUKP-0104-05**

Floor mounted door closer EN 1-4 set for double action doors. Supplied with all double action top centre and bottom strap. Adjustable closing power, speed and latch action. Maximum door weight of 150Kg. Maximum door width of 1100mm. Maximum door opening angle at 170°

Tested and approved to BS EN1154:1997 Class 3/8/4-1/1/1/3
EN 1634-1 tested - Suitable for upto 1 hour on timber door sets
Includes Intumescent pack for double action accessories
CE Marked



Colours shown above correspond to finishes K - Page 68



TS550 NV F-P FLOOR SPRING SINGLE & DOUBLE ACTION EN3-6

PROJECT CODE: **HUKP-0404-12**

For single & double action frequently used doors. Maximum opening angle 170° in single action. For fire and smoke protection doors in single and double action. Delayed closing adjustable upto 80° opening angle. Closing force, speed and latch action adjustable. All functions adjustable from above after installation.

Tested and approved to BS EN1154:2003 Class 3/8/6-3/1/1/4
CE marked and Certifire approved CF 259
EN 1634-1 tested - suitable for upto 1 hour on timber door sets
Suitable for steel doors and frames upto 4 hours fire-resistance
Not to be fitted to timber door sets without Intumescent protection



Colours shown above correspond to finishes K - Page 68



ELECTRO-MAGNETIC H/OPEN FLOOR SPRING EN4

PROJECT CODE: **HUKP-0204-05**

Hold open Electro-Magnetic floor spring 24V DC. Suitable for single and double action doors. Closing speed, backcheck and latch action easily adjustable. Maximum opening angle 175°. Power size EN 4. Maximum door weight 350Kg. Maximum door width 1100mm

Tested to BS EN1155:1997 Class code 3/8/4/1/1/3
CE marked and Certifire approved CF 5787
EN 1634-1 tested - Suitable for upto 1 hour on timber door sets
Suitable for single and double action applications **
Suitable for single action steel doors and frames upto 240 mins



Colours shown above correspond to finishes K - Page 68



** Timber door sets only for a double action application



StarTec



LOCKS & LATCHES

Our range of locks and latches has the functionality, design & finish for every project; whether it's for security and requires a complex master key system or to simply add privacy. The expert advice of Häfele's Projects 360° team can help you find the right locking solution to suit your project.

Featured product MORTICE SAH LOCK EURO PROFILE CYLINDER 72MM
PROJECT CODE: HUKP-0301-01



MORTICE SASH LOCK EURO PROFILE CYLINDER 72MM

PROJECT CODE: **HUKP-0103-01**

Latchbolt operated by lever handles, deadbolt by euro cylinder. Hold-tite spindle spring. Heavy sprung for unsprung furniture. 72 mm lock centres / 55mm backset. Radius forend (square also available) Stainless steel 24mm width. Reversible left and right hand Latchbolt follower: 8mm. Pierced at 38mm c.c. for bolt through fixing.

Certified in compliance with EN 12209:2003
EN 12209 Classification 3/X/8/1/0/G/3/B/C/2/0
DoP No.: 911.02.A
Certifire CF 5395



Colours shown above correspond to finishes A - Page 9



* Other finishes available to special order



MORTICE BATHROOM LOCK STAINLESS STEEL 78MM c.c.

PROJECT CODE: **HUKP-0103-05**

Latchbolt follower: 8 mm for use with sprung furniture. Hold-tite spindle spring. Heavy sprung for unsprung furniture. Deadbolt with 8mm sq follower operated by WC turn & release set. 78 mm lock centres / 55mm backset. Radius forend (square also available) Stainless steel 24mm width. Reversible left and right hand. Pierced at 38mm c.c. for bolt through fixing.

Certified in compliance with EN 12209:2003
EN 12209 Classification 3/S/8/1/0/F/-/B/G/2/0
DoP No.: 911.02.B
Certifire CF 5395



Colours shown above correspond to finishes A - Page 9



* Other finishes available to special order



MORTICE EURO DEADLOCK STAINLESS STEEL 55MM BACKSET

PROJECT CODE: **HUKP-0103-23**

Deadbolt 2-turn operated by euro profile cylinder. Backset 55mm. Radius forend (square also available) Stainless steel 24mm width. Striker plate Stainless Steel 88 x 24mm supplied. Reversible left and right hand. Pierced at 38mm c.c. for bolt through fixing.

Certified in compliance with EN 12209:2003
EN 12209 Classification 3/X/8/1/0/G/3/B/O/0/0
Certifire CF 5395



Colours shown above correspond to finishes A - Page 9



* Other finishes available to special order



STARTEC MORTICE LATCH STAINLESS STEEL 55MM BACKSET

PROJECT CODE: **HUKP-0103-25**

Latchbolt follower: 8mm - operated by lever handle. Hold-tite spindle spring. Heavy sprung for unsprung furniture. Backset 55mm. Radius forend (square also available) Stainless steel 24mm width. Reversible left and right hand. Pierced at 38mm c.c. for bolt through fixing.

304 Grade Stainless Steel



Colours shown above correspond to finishes A - Page 9



* Other finishes available to special order



MORTICE EURO NIGHTLATCH STAINLESS STEEL 60MM BACKSET

PROJECT CODE: **HUKP-0103-11**

Nightlatch operation with anti-thrust deadlocking snib. Hold-tite spindle spring. Heavy sprung for unsprung furniture. Latchbolt operated by lever handle from the inside only. Euro cylinder operation from the outside. 24mm forend radiused. Unhanded - Latchbolt easily reversible. Pierced at 38mm c.c. for bolt through fixing.

Certified in compliance with EN 12209:2003
EN 12209 Classification 3/X/8/1/0/G/3/B/O/0/0
Tested to BS EN 1634-1:2000
Suitable for timber fire doors FD30 + FD60



Colours shown above correspond to finishes A - Page 9



* Other finishes available to special order



MORTICE EURO ESCAPE LOCK STAINLESS STEEL 60MM BACKSET

PROJECT CODE: **HUKP-0103-15**

Internal side escape at all times by depressing the lever handle. Hold-tite spindle spring. Heavy sprung for unsprung furniture. Latchbolt and deadbolt operated by lever or turn from the inside. Euro cylinder operation from the outside. 24mm forend radiused. Unhanded - Latchbolt easily reversible. Pierced at 38mm c.c. for bolt through fixing.

Only requires a lever depression of 25° to fully retract latch bolt
Tested to BS EN 1634-1:2000
Suitable for timber fire doors FD30 + FD60



Colours shown above correspond to finishes A - Page 9



* Other finishes available to special order



LIFT TO LOCK MORTICE SET STAINLESS STEEL 60MM BACKSET

PROJECT CODE: **HUKP-0103-14**

Lift to lock mortice bathroom lock set with roller bolt 60mm B/set. Outside: roller bolt is released by normal use of lever to open. Indicator Emergency release is operates as coin release. Inside: Upward motion of lever handle locks the door. Exit: further motion of lever downwards deadbolt is withdrawn. Set includes unsprung levers to suit and "Lift to Lock" signage. Available in radius (shown) or square forend 24mm width.

Certified in compliance with EN 12209:2003
Handle sets complies with design features for BS8300
Tested to BS EN 1634-1:2000
Suitable for timber fire doors FD30 + FD60



Colours shown above correspond to finishes A - Page 9

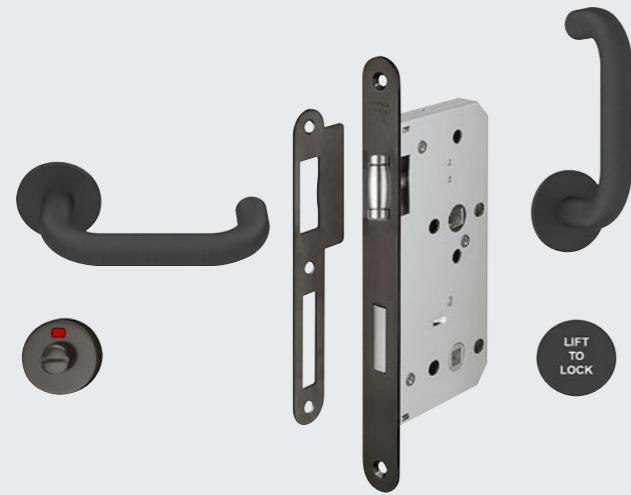

MORTICE BOX LATCH STAINLESS STEEL 55MM BACKSET

PROJECT CODE: **HUKP-0103-41**

Latchbolt follower: 8mm. Hold-tite spindle spring. Heavy sprung for unsprung furniture. Backset 55mm. Available as square or radius forend. Forend stainless steel 24mm width. Reversible left and right hand Pierced at 38mm c.c. for bolt through fixing.

Certified in compliance with EN 12209:2003
EN 12209 Classification 3/X/B/1/0/G/-/B/0/2/0
Certifire CF 5395



Colours shown above correspond to finishes A - Page 9



MORTICE EURO DEADLOCK STAINLESS STEEL 55MM BACKSET

PROJECT CODE: **HUKP-0103-43**

Deadbolt operated by euro profile cylinder. Backset 55mm. Modular box case size 84x95mm. Available as square or radius forend. Forend stainless steel 24mm width. Deadbolt Stainless steel 20mm throw (double throw). Pierced at 38mm c.c. for bolt through fixing.

Certified in compliance with EN 12209:2003
EN 12209 Classification 3/X/B/1/0/G/3/B/C/0/0
Certifire CF 5395



Colours shown above correspond to finishes A - Page 9



MORTICE TOILET CUBICLE LOCK STAINLESS STEEL 57MM BACKSET

PROJECT CODE: **HUKP-0203-01**

Deadbolt operated by 8mm WC turn & emergency release. Backset 57mm. Case size 76x49mm. Forend radius. Stainless steel 18mm slimline width. Deadbolt Steel. Nickel plated 12mm throw. Pierced at 38mm c.c. for bolt through fixing.

Grade 304 Stainless Steel



Colours shown above correspond to finishes A - Page 9



MORTICE TOILET CUBICLE LOCK STAINLESS STEEL 55MM BACKSET

PROJECT CODE: **HUKP-0103-45**

Deadbolt operated by 8mm WC turn & emergency release. Backset 55mm. Modular box case size 84x95mm. Available as square or radius forend. Forend stainless steel 24mm width. Deadbolt Stainless steel 10mm throw (single throw). Pierced at 38mm c.c. for bolt through fixing.

Grade 304 Stainless Steel



Colours shown above correspond to finishes A - Page 9





MAGNETIC MORTICE LATCH STAINLESS STEEL 55MM BACKSET

PROJECT CODE: **HUKP-0103-46**

Latchbolt retracted by lever handle silent operation.
Latchbolt remains hidden whilst door in open position.
Magnet throws into keeper plate supplied on closure.
Backset 55mm / 85mm case size. Forend radius.
Stainless steel 20mm width. Pierced at 38mm c.c. for bolt through fixing.

Residential use. Standard springing on door furniture
Suitable only for non-fire doors
Silent operation and retracted latch bolt whilst open
304 Grade Stainless Steel



Colours shown above correspond to finishes A - Page 9



* Other finishes available to special order



MAGNETIC MORTICE BATHROOM LOCKCASE 55MM BACKSET

PROJECT CODE: **HUKP-0103-48**

Latchbolt retracted by lever handle. Latchbolt remains hidden whilst door in open position. Magnet throws into keeper plate supplied on closure. WC turn and emergency release (8mm) throws deadbolt. Backset 55mm / 85mm case size / 78mm c.c. Forend radius. Stainless steel 20mm width. Pierced at 38mm c.c. for bolt through fixing.

Residential use. Standard springing on door furniture
Suitable only for non-fire doors
Silent operation and retracted latch bolt whilst open
304 Grade Stainless Steel



Colours shown above correspond to finishes A - Page 9



* Other finishes available to special order



SLIDING DOOR WC LOCKSET 50MM BACKSET

PROJECT CODE: **HUKP-0103-49**

Sliding door WC Hookbolt set with turn & release and flush pull. Suitable for Pocket doors 35-52mm door thickness. Deadbolt operates via square turn or coin release 8mm follower. Backset: 50mm / case size 100 x 67.5mm. Forend radius 158mm x 16mm. Strike plate included. Brass forend, WC bolt and flush pull. Lock case steel.

Pocket door handle requires 21mm depth x 25mm Ø fixing
Handle set to be flush mounted (38-45mm door thickness)
Deadbolt follower 8mm square



Colours shown above correspond to finishes A - Page 9

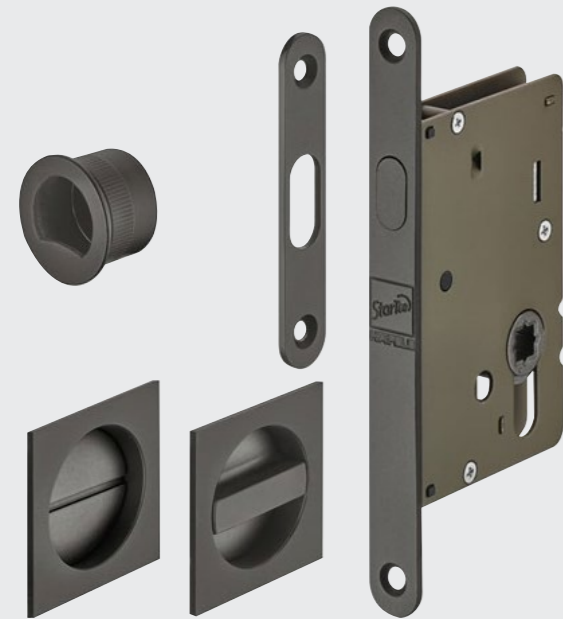

88



SLIDING DOOR WC LOCKSET 50MM BACKSET

PROJECT CODE: **HUKP-0103-50**

Sliding door WC Hookbolt set with turn & release and flush pull. Suitable for Pocket doors 35-52mm door thickness. Deadbolt operates via round turn or coin release 8mm follower. Backset: 50mm / case size 100 x 67.5mm. Forend radius 158mm x 16mm. Strike plate included. Brass forend, WC bolt and flush pull. Lock case steel.

Pocket door handle requires 19.5mm depth x 25mm Ø fixing
Handle set to be flush mounted (38-45mm door thickness)
Deadbolt follower 8mm square



Colours shown above correspond to finishes A - Page 9



89

MULTI-POINT LOCK - 2 SHOOT-BOLTS STAINLESS 2170mm L / 65MM BACKSET

PROJECT CODE: **HUKP-0103-51**

For flush timber doors - Forend 20mm in satin stainless effect. Reversible suitable for left and right hand applications. Prepared for Euro cylinder 92mm c.c. 2 locking shoot bolts (top /bottom) and 20mm deadbolt centre. Operation by lever handle and key for latch and deadbolt. Length 2170mm / Backset 65mm / includes follower adaptor.

Total length 2170mm. (Lever handle height 1020mm)
Fore-end finished in stainless steel effect 20mm width
Centre case height 210mm x 83mm
Anti-lift Shoot bolts Steel
Galvanized striker plates - 3 piece included



Colours shown below



Specially designed shoot bolts in that the geometry of the bolts ensure an increased tightening into the keep.



Stainless Steel Effect



Galvanized Silver Colour



MULTI-POINT LOCK - 2 HOOKBOLTS STAINLESS 2170MM L / 65mm BACKSET

PROJECT CODE: **HUKP-0103-52**

For flush timber doors - Forend 20mm in satin stainless effect. Reversible suitable for left and right hand applications. Prepared for Euro cylinder 92mm c.c. 2 locking Hookbolts (top /bottom) and 20mm deadbolt centre. Operation by lever handle and key for latch and deadbolt. Length 2170mm / Backset 65mm / includes follower adaptor.

Total length 2170mm. (Lever handle height 1020mm)
Fore-end finished in stainless steel effect 20mm width
Centre case height 210mm x 83mm
Anti-lift Hookbolts Steel
Galvanized keeps - 3 piece included (or lock strip available)



Colours shown below



The tapering design of the hook bolts close tightly into the keeper ensuring a secure locked position.



Stainless Steel Effect



Galvanized Silver Colour



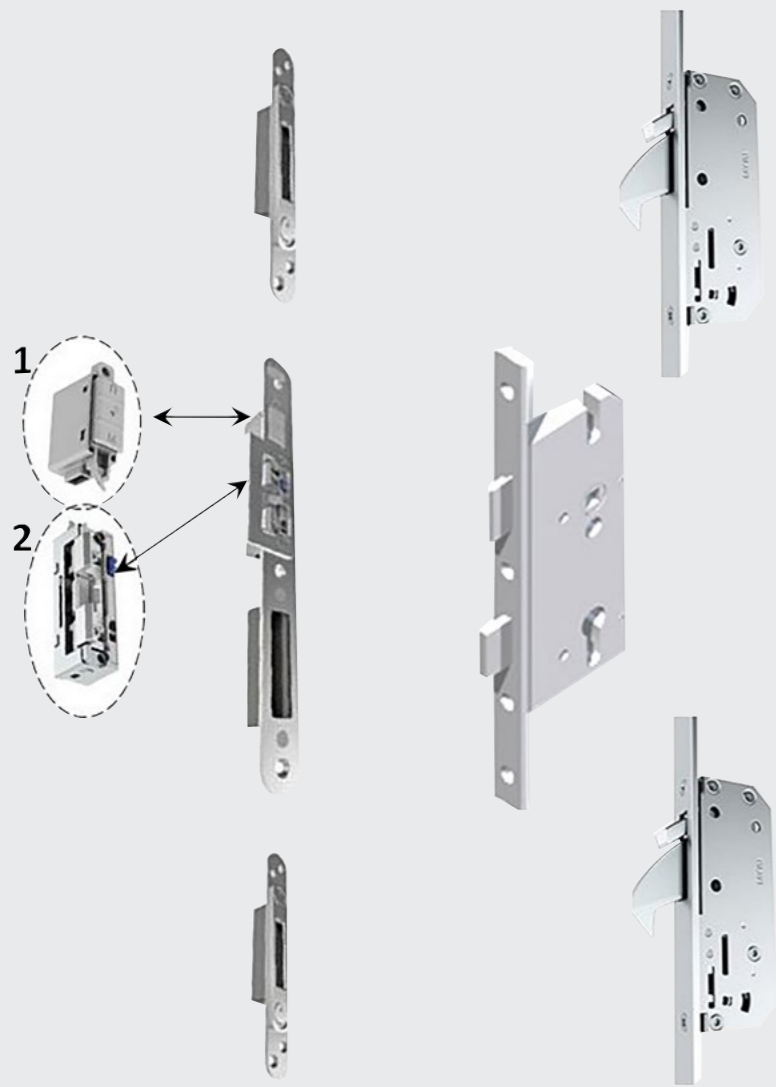

AV3 AUTOMATIC MULTIPOINT AUTO DEADLOCKING HOOKBOLT LOCK

PROJECT CODE: **HUKP-0403-01**

Auto deadlocking feature on door closure without lever operation. Latch retraction via key as hook bolt guides prevent side load. Daytime passage function facility on centre keep to allow egress. Central magnetic slam action trigger ensures hooks thrown evenly. Forend: 20mm width with radius both ends in choice of finishes. Backsets available 45mm, 55mm + 65mm for doors 1875-2230mm.

AV3 Auto-deadlocking system has achieved German Vds "class B"
Suitable for entrance doors requiring high burglar resistance
PAS 24 & ADQ compliant and system is Police Secured By Design
AV3-E can be easily retro fitted to this system to allow access control to upgrade to the blue-Matic electrically operated lock



Colours shown above right



FINISHES



Stainless Steel Effect



Matt Chrome

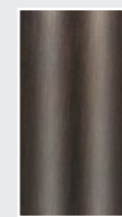

Antique Bronze



Anthracite

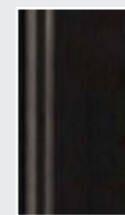

Graphite Black

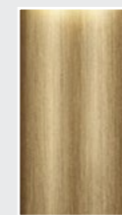

Antique Brass

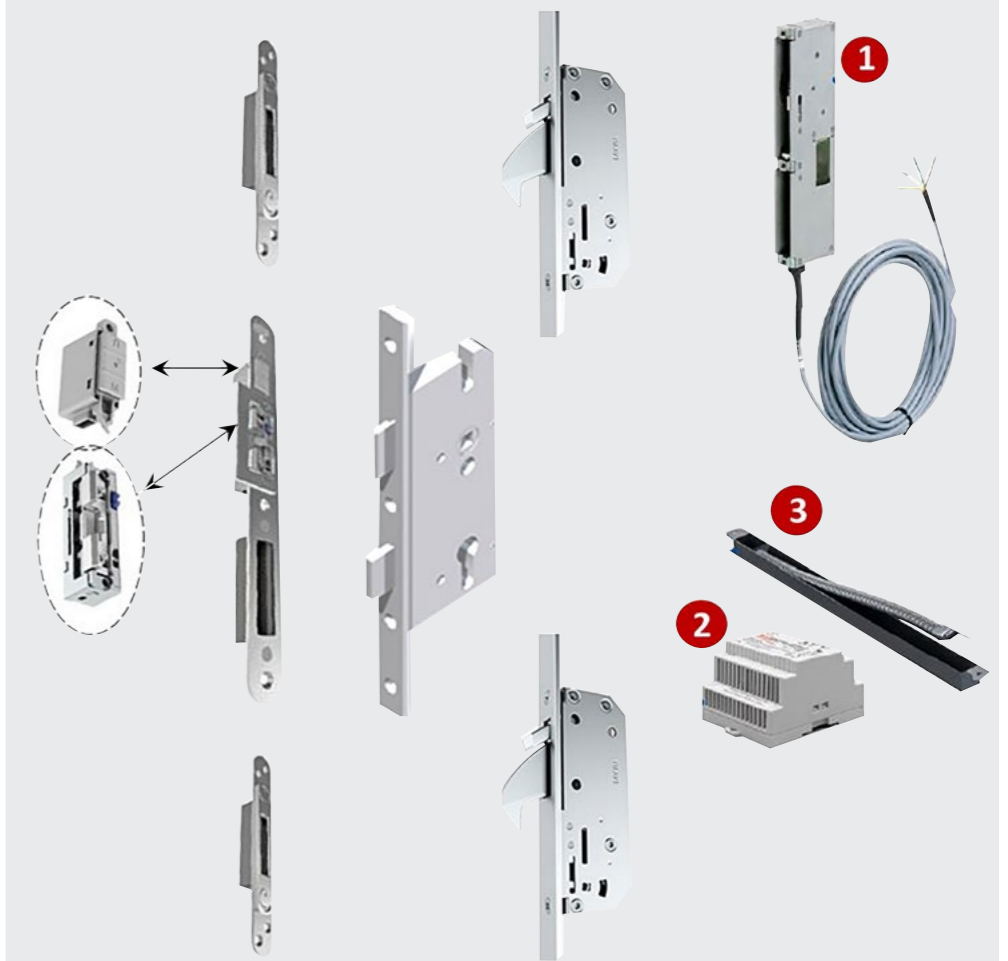

AV3-E ELECTRONIC MULTIPOINT AUTO DEADLOCKING BLUE-MATIC LOCK

PROJECT CODE: **HUKP-0403-05**

AV3-E blueMatic automatic motorized opening function. Auto deadlocking feature on door closure without lever operation. Operation by key fobs, fingerprint reader or smart phone App. Central magnetic slam action trigger ensures hooks thrown evenly. Forend: 20mm width with radius both ends in choice of finishes. Backsets available 45mm, 55mm + 65mm for doors 1875-2230mm.

AV3 Auto-deadlocking system has achieved German Vds "class B"
Suitable for entrance doors requiring high burglar resistance
PAS 24 & ADQ compliant and system is Police Secured By Design
AV3-E can be easily retro fitted into AV3 to allow access control to upgrade to the blue-Matic electrically operated lock



Colours shown above left





HORIZONTAL MORTICE LATCH STAINLESS STEEL 127MM BACKSET

PROJECT CODE: **HUKP-0203-04**

Reversible Latch bolt operated by knob. Light sprung follower, 8mm brass, two-way action. Forend square. Stainless steel 152 x 25mm. Reversible left and right hand. Follower has 2-way action. Pierced at 38mm c.c. for bolt through fixing.

Certified in compliance with EN 12209:2003
EN 12209 Classification 1/M/8/1/0/F/-/B/O/2/0
Tested to BS EN 1634-1: 2000
Suitable for timber fire doors FD30 + FD60



Colours shown above correspond to finishes A - Page 9



HORIZONTAL MORTICE CYLINDER SASHLOCK 57MM BACKSET

PROJECT CODE: **HUKP-0203-07**

Reversible Latch bolt operated by knob. Deadbolt by cylinder key. Light sprung follower, 8mm brass, two-way action. Deadbolt: Brass, 14mm throw, 2 hardened rollers. Forend square, Stainless Steel 152 x 25mm width. Euro profile cylinder (not supplied). Pierced at 38mm c.c. for bolt through fixing.

Certified in compliance with EN 12209:2003
EN 12209 Classification 1/M/8/1/0/F/-/B/O/2/0
Tested to BS EN 1634-1: 2000
Suitable for timber fire doors FD30 + FD60



Colours shown above correspond to finishes A - Page 9

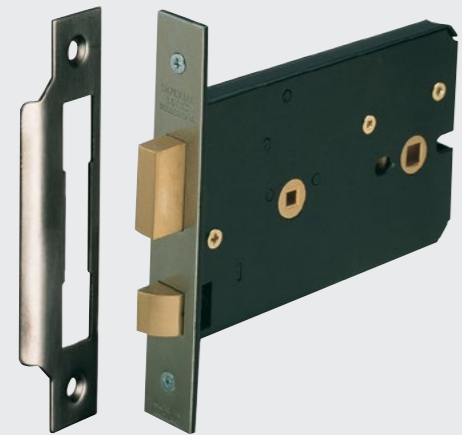

HORIZONTAL MORTICE BATHROOM LOCK STAINLESS STEEL 57mm BACKSET

PROJECT CODE: **HUKP-0203-06**

Reversible Latch bolt operated by knob. Deadbolt by WC set. Light sprung follower, 8mm brass, two-way action. Deadbolt: Brass, 14mm throw. 5mm follower (8mm available). Forend square, Stainless Steel 152 x 25mm width. Pierced at 38mm c.c. for bolt through fixing.

Certified in compliance with EN 12209:2003
Tested to BS EN 1634-1: 2000
Suitable for timber fire doors FD30 + FD60



Colours shown above correspond to finishes A - Page 9



HORIZONTAL MORTICE SASHLOCK STAINLESS STEEL 57MM BACKSET

PROJECT CODE: **HUKP-0203-05**

Reversible Latch bolt operated by knob. Deadbolt by key. Light sprung follower, 8mm brass, two-way action. Deadbolt: Brass, 16mm throw, 5 Lever mechanism. Forend square, Stainless Steel 152 x 25mm width. Differs: 200 differs. 2 Lever keys included. Pierced at 38mm c.c. for bolt through fixing.

Certified in compliance with EN 12209:2003
EN 12209 Classification 1/M/8/1/0/F/-/B/O/2/0
Tested to BS EN 1634-1: 2000
Suitable for timber fire doors FD30 + FD60



Colours shown above correspond to finishes A - Page 9



HD MORTICE BOX LATCH STAINLESS STEEL 57MM BACKSET

PROJECT CODE: **HUKP-0203-02**

Latchbolt reversible operated by lever handle. Backset 57mm / Case size 76x62mm. Forend square (radius available) . Stainless steel 25mm width. Follower: Heavy duty 8mm for use with unsprung furniture. Pierced at 38mm c.c. for bolt through fixing.

Certified in compliance with EN 12209:2003
Tested to BS EN 1634-1:2000
Suitable for timber fire doors FD30 + FD60



Colours shown above correspond to finishes A - Page 9



MORTICE TUBULAR LATCH STAINLESS STEEL 100MM BACKSET

PROJECT CODE: **HUKP-0203-03**

Latchbolt reversible operated by lever or knobset. Backset 100mm / Case size 123mm (other sizes available). Forend square (radius available) . Stainless steel 27mm width Follower: 8mm sprung for use with knob furniture - 2 way action. Heavy Duty springing available on request. Certified in compliance with EN 12209:2003
Tested to BS EN 1634-1:2000
Suitable for timber fire doors FD30 + FD60



Colours shown above correspond to finishes A - Page 9



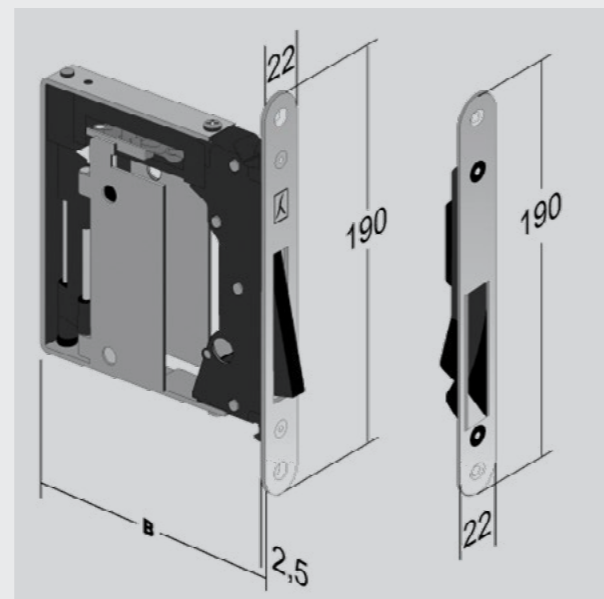

NO-HA MAGNETIC LATCH FLUSH HANDLE PASSAGE SET

PROJECT CODE: **HUKP-0303-01**

Latchbolt reversible operated by lever or knobset. Backset 100mm / Case size 123mm (other sizes available). Forend square (radius available) . Stainless steel 27mm width. Follower: 8mm sprung for use with knob furniture - 2 way action. Heavy Duty springing available on request. Pierced at 38mm c.c. for bolt through fixing.

Certified in compliance with EN 12209:2003
Tested to BS EN 1634-1:2000
Suitable for timber fire doors FD30 + FD60



Colours shown right



- Fully concealed and flush magnetic latch set
- Latchbolt retracts with handle operation
- Magnet throws latch into keeper plate supplied on door closure
- Case size 132x129mm (Privacy WC version also available)
- Choice of MDF or metal cover to allow extract match door face finish
- Panel of door appears completely smooth and flush



Matt Chrome



Polished Chrome

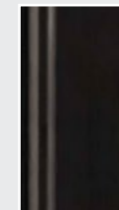

Matt Black



Satin Chrome



Polished Brass

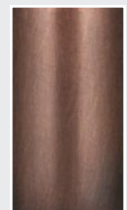

Varnished Bronze*



*Other finishes available to special order

EURO PROFILE CYLINDER SINGLE MK REGISTERED EN1303

PROJECT CODE: **HUKP-0503-01**

Master Key system to 100,000 differs with Trademark Protection. Anti-Bump protection highest Grade 6 key security. Comprises 12 sectionally arranged core and housing pins. Vertical keyprofile has optimised angle cuts for smooth rotation. Cylinder includes 6 sprung solid tumblers set axially** each side. Sizes available 31/10, 35/10, and 40/10mm- others on application.

EN1303:2005 Performance tested Class: 1/6/-/1/-/C/6/2
German Vds inspected and approved 2156:1 AZ TM Registered
Tested to EN 1634-1:2000 suitable for fire and smoke door assemblies subject to satisfactory assessment.



* Other finishes available to special order



EURO PROFILE CYLINDER SINGLE - HÄFELE PREMIER MK SUITE

PROJECT CODE: **HUKP-0603-01**

Multi-profile key suite for complex Master Key systems. Patent protection upto 2032 to prevent illegal key duplication. 36,000 differs under 1 Master Key. (key blanks are not available). Drill protection in cylinder barrel and body. Anti-pick, Anti-drill and Anti-bump protection.

EN1303:2015 Performance tested Class: 1/6/0/B/0/C/6/C/D
Successfully incorporated into PAS24 solutions
EN 1634-1:2000 suitable for fire and smoke door assemblies subject to satisfactory assessment.



* Other finishes available to special order

EURO PROFILE CYLINDER DOUBLE MK REGISTERED EN1303

PROJECT CODE: **HUKP-0503-02**

Master Key system to 100,000 differs with Trademark Protection. Anti-Bump protection highest Grade 6 key security. Comprises 12 sectionally arranged core and housing pins. Vertical keyprofile has optimised angle cuts for smooth rotation. Cylinder includes 6 sprung solid tumblers set axially** each side. Sizes available 30/30, 35/35, and 40/40mm- offset on application.

EN1303:2005 Performance tested Class: 1/6/-/1/-/C/6/2
German Vds inspected and approved 2156:1 AZ TM Registered
Tested to EN 1634-1:2000 suitable for fire and smoke door assemblies subject to satisfactory assessment.



* Other finishes available to special order



EURO PROFILE CYLINDER DOUBLE-HÄFELE PREMIER MK SUITE

PROJECT CODE: **HUKP-0603-02**

Multi-profile key suite for complex Master Key systems. Patent protection upto 2032 to prevent illegal key duplication. 36,000 differs under 1 Master Key. (key blanks are not available). Drill protection in cylinder barrel and body. Anti-pick, Anti-drill and Anti-bump protection.

EN1303:2015 Performance tested Class: 1/6/0/B/0/C/6/C/D
Successfully incorporated into PAS24 solutions
TS007 1* and 3* options available on application
EN 1634-1:2000 suitable for fire and smoke door assemblies subject to satisfactory assessment



* Other finishes available to special order

EURO PROFILE CYLINDER CYL & TURN MK REGISTERED EN1303

PROJECT CODE: **HUKP-0503-03**

Master Key system to 100,000 differs with Trademark Protection. Anti-Bump protection highest Grade 6 key security. Comprises 12 sectionally arranged core and housing pins. Vertical keyprofile has optimised angle cuts for smooth rotation. Cylinder includes 6 sprung solid tumblers set axially** each side.

EN1303:2005 Performance tested Class: 1/6/-/1/-/C/6/2
German Vds inspected and approved 2156:1 AZ TM Registered
Tested to EN 1634-1:2000 suitable for fire and smoke door assemblies subject to satisfactory assessment.



* Other finishes available to special order



EURO PROFILE CYLINDER CYL & TURN- HÄFELE PREMIER MK

PROJECT CODE: **HUKP-0603-03**

Multi-profile key suite for complex Master Key systems. Patent protection upto 2032 to prevent illegal key duplication. 36,000 differs under 1 Master Key. (key blanks are not available). Drill protection in cylinder barrel and body. Anti-pick, Anti-drill and Anti-bump protection.

EN1303:2015 Performance tested Class: 1/6/0/B/0/C/6/C/D
Successfully incorporated into PAS24 solutions
TS007 1* and 3* options available on application
EN 1634-1:2000 suitable for fire and smoke door assemblies subject to satisfactory assessment



* Other finishes available to special order



FLUSH HANDLES

If you require a stunning result but need to keep it low profile to maximise space usage or avoid protruding surfaces, a flush handle is a perfect fit.

Featured product FLUSH PULL SOLID BRASS
PROJECT CODE: HUKP-0201-22

SERVICES

LEVER HANDLES

PULL HANDLES

DOOR KNOBS

HINGES

DOOR CONTROLS

LOCKS & LATCHES

FLUSH HANDLES

ANCILLARY HARDWARE

<

>



FSB 4255 BATHROOM FLUSH PULL SLIDING DOOR WC LOCK SET

PROJECT CODE: **HUKP-0401-35**

Sliding door WC bathroom lockset for double sliding doors. Includes a red/green indicator and has emergency release. Flush fitting including hook bolt mortice lockset. complete with integrated sprung handle.

Manufactured in stainless steel to grade 304 (1.4301)
 Ideally suited for high end interior applications
 High corrosion resistance where integrity of material is a factor
 Concealed fixing to suit doors from 38 to 42mm thick



Colours shown above correspond to finishes B - Page 17



FSB 4255 BATHROOM FLUSH PULL SLIDING DOOR WC LOCK SET

PROJECT CODE: **HUKP-0401-35**

FSB 4250 FLUSH PULL SPRUNG

PROJECT CODE: **HUKP-0401-36**

Enclosed designed flush pull with sprung cover suitable for sliding timber doors.

Manufactured in stainless steel to grade 304 (1.4301)
 Ideally suited for interior applications
 High corrosion resistance where integrity of material is a factor
 Perfect flush fitting possible with routing jig 03 0462 0020



Colours shown above correspond to finishes B - Page 17



FSB 4251 FLUSH PULL SPRUNG

PROJECT CODE: **HUKP-0401-37**

An enclosed rectangular design with sprung cover suitable for sliding timber doors.

Manufactured in stainless steel to grade 304 (1.4301)
 Ideally suited for interior applications
 High corrosion resistance where integrity of material is a factor
 Perfect flush fitting possible with routing jig 03 0462 0020



Colours shown above correspond to finishes B - Page 17



FSB 4252 FLUSH PULL SPRUNG

PROJECT CODE: **HUKP-0401-38**

A 75mm diameter circular design with a sprung cover. This is suitable for sliding timber doors.

Manufactured in Aluminium to DIN 1725
 Ideally suited for commercial and residential applications
 Perfect flush fitting possible with routing jig 03 0462 0020



Colours shown above correspond to finishes B - Page 17

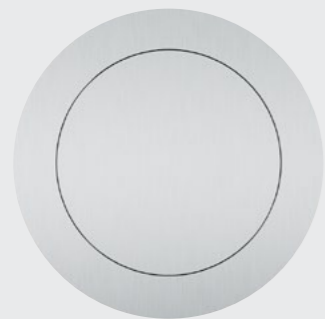

FSB 4253 FLUSH PULL SPRUNG

PROJECT CODE: **HUKP-0401-39**

An enclosed 70mm x 70mm square design with a sprung cover suitable for sliding timber doors.

Manufactured in stainless steel to grade 304 (1.4301)
 Ideally suited for interior applications
 High corrosion resistance where integrity of material is a factor
 Perfect flush fitting possible with routing jig 03 0462 0020



Colours shown above correspond to finishes B - Page 17

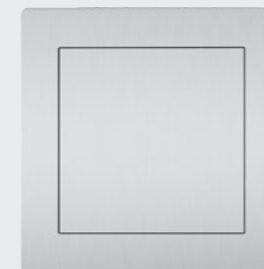



FLUSH PULL WC SET TURN AND RELEASE BRASS

PROJECT CODE: **HUKP-0201-21**

A sliding door flush pull with bathroom turn and release. In a straight step design with single lip. In solid brass complete with 5mm spindle, attached to release.

Suitable for door thickness 44-55mm
11mm depth / 3mm lip
Concealed pin fix



Colours shown above correspond to finishes D - Page 29



FLUSH PULL SET EDGE PULL SOLID BRASS

PROJECT CODE: **HUKP-0201-24**

A square sliding door flush pull with integrated gravity edge pull in solid brass with reeded design.

Other functions available (pierced for euro profile or WC function).

Manufactured in stainless steel to grade 304 (1.4301)
Ideally suited for interior applications
High corrosion resistance where integrity of material is a factor
Perfect flush fitting possible with routing jig 03 0462 0020



Colours shown above correspond to finishes D - Page 29



FLUSH PULL SOLID BRASS

PROJECT CODE: **HUKP-0201-22**

A solid brass flush pull with a single lip and in a reeded design. Available in various sizes up to 306mm x 76mm maximum.

11mm depth / 3mm lip
Concealed pin fix



Colours shown above correspond to finishes D - Page 29

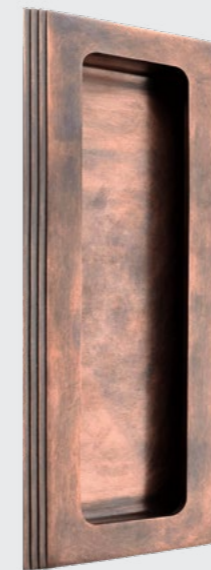

FLUSH PULL SOLID BRASS

PROJECT CODE: **HUKP-0201-23**

A solid brass flush pull with a single lip and a straight step edge design. Available in various sizes up to 306mm x 76mm maximum.

11mm depth / 3mm lip
Concealed pin fix



Colours shown above correspond to finishes D - Page 29



FLUSH PULL HANDLE WITH INTEGRATED FINGER PULL

PROJECT CODE: **HUKP-0501-08**

A flush pull set for sliding pocket doors. Designed by Mario Mazzer it comprises of a flush sprung section where no lock is required with an integrated finger / gravity pull for the leading edge.

Suitable for door thickness 38mm - 45mm



Colours shown above correspond to finishes D - Page 29



SLIDING DOOR MORTICE LOCK BATHROOM / WC FUNCTION

PROJECT CODE: **HUKP-0501-14**

A flush pull set for sliding pocket door including mortice lock. Designed by Mario Mazzer it comprises of a flush sprung mechanism with hook bolt and 8mm deadbolt follower. Integrated finger / gravity pull for the leading edge.

Suitable for door thickness 38mm - 45mm
Supplied with 90mm x 18mm matching strike plate



Colours shown above correspond to finishes D - Page 29





ANCILLARY HARDWARE

Door accessories are an important part of a building. Legally compliant mandatory and information signage, door stops and protection plates; in this section we have you covered.

Featured product DOOR STOP BUFFERED FLOOR MOUNTED Ø 60MM ST STEEL
PROJECT CODE: HUKP-0105-09

TURN & RELEASE SET 316 STAINLESS STEEL

PROJECT CODE: **HUKP-0101-46**

WC turn set with red/green indicator with "Peanut" design turn. 4mm low profile round rose. Complete with 5mm square spindle. Concealed fixing to suit doors up to 44 mm thick.

Manufactured in solid section stainless steel to grade T316



Colours shown above correspond to finishes A - Page 9



LARGE TURN & RELEASE SET 316 STAINLESS STEEL

PROJECT CODE: **HUK-0101-49**

WC turn set without indicator with large design turn. 4mm low profile round rose. Complete with 5mm square spindle. Concealed fixing to suit doors up to 44 mm thick.

Stainless steel to grade 316L
Large disabled turn - to BS8300
Ideally suited to applications within an ADM environment



Colours shown above correspond to finishes A - Page 9

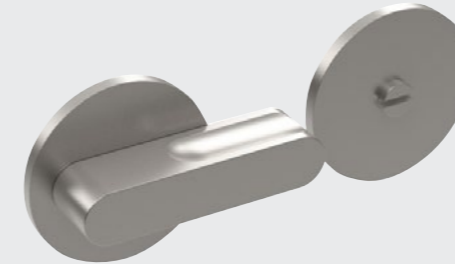

TURN & RELEASE SET 316 STAINLESS STEEL

PROJECT CODE: **HUKP-0101-47**

WC turn set without indicator with "Peanut" design turn. 4mm low profile round rose. Complete with 5mm square spindle. Concealed fixing to suit doors up to 44 mm thick.

Manufactured in solid section stainless steel to grade T316



Colours shown above correspond to finishes A - Page 9

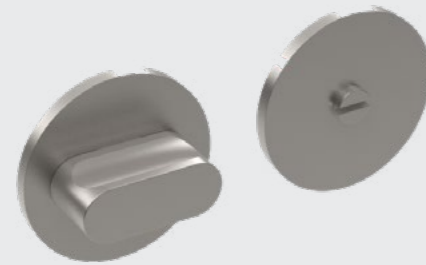

TURN & RELEASE SET 316 STAINLESS STEEL

PROJECT CODE: **HUKP-0101-50**

WC turn set without indicator with "Peanut" design turn. 4mm low profile square rose. Complete with 5mm square spindle. Concealed fixing to suit doors up to 44 mm thick.

Manufactured in solid section stainless steel to grade T316



Colours shown above correspond to finishes A - Page 9



LARGE TURN & RELEASE SET 316 STAINLESS STEEL

PROJECT CODE: **HUKP-0101-48**

WC turn set with red/green indicator with large design turn. 4mm low profile round rose. Complete with 5mm square spindle. Concealed fixing to suit doors up to 44 mm thick.

Stainless steel to grade 316L
Large disabled turn - to BS8300
Ideally suited to applications within an ADM environment



Colours shown above correspond to finishes A - Page 9

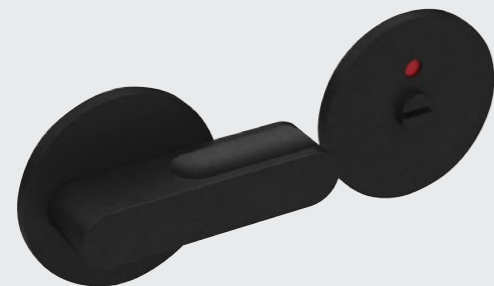

TURN & RELEASE SET 316 STAINLESS STEEL

PROJECT CODE: **HUKP-0101-51**

WC turn set with red/green indicator with "Butterfly" design turn. 4mm low profile round rose. Complete with 5mm square spindle. Concealed fixing to suit doors up to 44 mm thick.

Stainless steel to grade 316L
Elongated disabled turn - to BS8300
Ideally suited to applications within an ADM environment



Colours shown above correspond to finishes A - Page 9

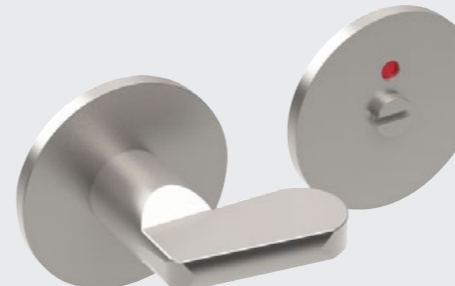

TURN & RELEASE SET 316 STAINLESS STEEL

PROJECT CODE: **HUKP-0101-58**

WC turn set with red / green indicator with long rod design turn. 4mm low profile round rose. Complete with 5mm square spindle. Concealed fixing to suit doors up to 44 mm thick.

Stainless steel to grade 316L
Elongated disabled turn - to BS8300
Ideally suited to applications within an ADM environment



Colours shown above correspond to finishes A - Page 9

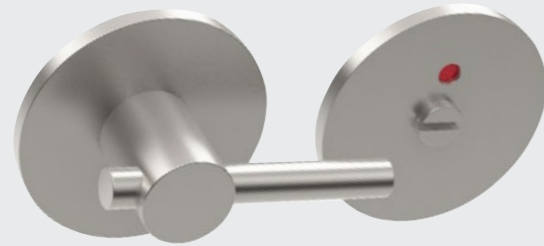

FSB 1704 EURO ESCUTCHEON

PROJECT CODE: **HUKP-0401-32**

Euro profile concealed fix escutcheon. 55mm Square with 7mm depth. Complete with bolt through fixings at 38mm c.c. Concealed fixing to suit doors from 39 to 58mm thick. Available in matching materials for lever handles.

Manufactured in stainless steel to grade 304 (1.4301)



Colours shown above correspond to finishes B - Page 17



* Aluminium Shot-Blasted finish

TURN & RELEASE SET 316 STAINLESS STEEL PVD

PROJECT CODE: **HUKP-0101-53**

WC turn set with indicator with straight bar design turn. Copper PVD coated. Complete with 5mm square spindle. Concealed fixing to suit doors up to 44 mm thick.

Manufactured in solid section stainless steel to grade T316
4mm low profile rose with elongated turn design - BS8300
Ideally suited to applications within ADM environment
High corrosion resistance where integrity of material is a factor



Colours shown above correspond to finishes A - Page 9

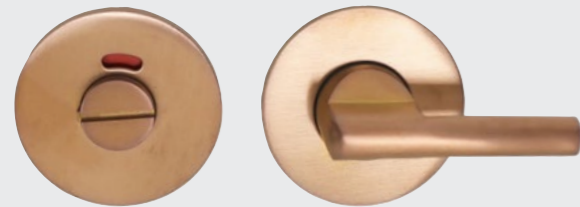

FSB 12 1735 WC SET

PROJECT CODE: **HUKP-0401-33**

Emergency release WC set with red / white indicator. 55mm diameter with 7mm depth. Complete with bolt through fixings at 38mm c.c. Concealed fixing to suit doors from 39 to 58mm thick. Available in matching materials for lever handles.

Manufactured in stainless steel to grade 304 (1.4301)



Colours shown above correspond to finishes B - Page 17



* Aluminium Shot-Blasted finish

FSB 1735 EURO ESCUTCHEON

PROJECT CODE: **HUKP-0401-31**

Euro profile concealed fix escutcheon. 55mm diameter with 7mm depth. Complete with bolt through fixings at 38mm c.c. Concealed fixing to suit doors from 39 to 58mm thick. Available in matching materials for lever handles.

Manufactured in stainless steel to grade 304 (1.4301)



Colours shown above correspond to finishes B - Page 17



* Aluminium Shot-Blasted finish

FSB 1704 SQUARE WC SET

PROJECT CODE: **HUKP-0401-34**

Emergency release WC set with red / white indicator. 55mm Square with 7mm depth. Complete with bolt through fixings at 38mm c.c. Concealed fixing to suit doors from 39 to 58mm thick. Available in matching materials for lever handles.

Manufactured in stainless steel to grade 304 (1.4301)



Colours shown above correspond to finishes B - Page 17



* Aluminium Shot-Blasted finish

EURO ESCUTCHEON REDED DESIGN SOLID BRASS

PROJECT CODE: **HUKP-0201-08**

Solid brass round euro escutcheon 44mm Ø. Reeded design for Linear and Hexagonal lever designs. Concealed 2-part fixing rose. Options for square profile rose version available.

Inner rose secured with 2 wood screws (supplied)
Hex head screw supplied to secure outer / inner rose together



Colours shown above correspond to finishes C - Page 23



WC SET TURN & RELEASE HEXAGONAL DESIGN SOLID BRASS

PROJECT CODE: **HUKP-0201-17**

Solid brass turn and release set 38mm Ø. Hexagonal design for Linear and Hexagonal lever designs. Concealed 2-part fixing rose. Suitable for door thickness 44mm - 65mm as standard.

Inner rose secured with wood screws (supplied)
Hex head screw supplied to secure outer / inner rose together
Complete with 5mm square spindle attached



Colours shown above correspond to finishes C - Page 23



EURO ESCUTCHEON PLAIN SOLID BRASS

PROJECT CODE: **HUKP-0201-11**

Solid brass round euro escutcheon 44mm Ø. Plain design for Bamboo and Straight lever designs. Concealed 2-part fixing rose. Options for square rose version available.

Inner rose secured with 2 wood screws (supplied)
Hex head screw supplied to secure outer / inner rose together



Colours shown above correspond to finishes C - Page 23



WC SET TURN & RELEASE BAR DESIGN SOLID BRASS

PROJECT CODE: **HUKP-0201-19**

Solid brass turn and release set 38mm Ø. Round bar design for Fusion lever handle. Large 32 x 14mm solid turn. Concealed 2-part fixing rose. Suitable for door thickness 44mm - 65mm as standard.

Inner rose secured with wood screws (supplied)
Hex head screw supplied to secure outer / inner rose together
Complete with 5mm square spindle attached



Colours shown above correspond to finishes C - Page 23



WC SET TURN & RELEASE REDED DESIGN SOLID BRASS

PROJECT CODE: **HUKP-0201-15**

Solid brass turn and release set 38mm Ø. Large 32 x 15mm solid turn. Reeded design for Linear and Hexagonal lever designs. Concealed 2-part fixing rose. Suitable for door thickness 44mm - 65mm as standard.

Inner rose secured with wood screws (supplied)
Hex head screw supplied to secure outer / inner rose together
Complete with 5mm square spindle attached



Colours shown above correspond to finishes C - Page 23



SECURITY EURO ESCUTCHEON STAINLESS STEEL PROTECTION PLATE

PROJECT CODE: **HUKP-0103-54**

Euro profile concealed fix security escutcheon & protection plate. 55mm diameter with 15mm depth (external) and 8.5mm (internal). Complete with M5 bolt through fixings at 38mm c.c. Concealed fixing to suit doors from 38 to 87mm thick.

Manufactured in stainless steel to grade 304 (1.4301)
Impact resistance DIN 18257 Category 1 (Protection Class 2)
Compensates for cylinder projection of 10mm from door face



Colours shown above correspond to finishes C - Page 23





EURO ESCUTCHEON Ø 52mm

PROJECT CODE: **HUKP-0101-60**

Euro profile concealed escutcheon 4mm depth complete with bolt through fixings at 38mm to suit doors from 39mm to 58mm thick, Grade 316 St/Steel

Manufactured in solid section stainless steel to grade T316



Colours shown above correspond to finishes A- Page 9



DOOR STOP BUFFERED FLOOR MOUNTED Ø 52MM ST/STEEL

PROJECT CODE: **HUKP-0105-10**

Circular pattern floor mounted door stop. Concealed fixing. Diameter 52mm / 27mm height. Black rubber buffered. Grade 304 Stainless Steel (Ø 40mm).

Concealed dowel screw fixings included for secure fix



OVAL EURO ESCUTCHEON 62mm

PROJECT CODE: **HUKP-0101-65**

Euro profile concealed oval escutcheon 4mm depth complete with bolt through fixings at 38mm to suit doors from 39mm to 58mm thick, Grade 316 St/Steel

Manufactured in solid section stainless steel to grade T316



Colours shown above correspond to finishes A- Page 9



DOOR STOP BUFFERED FLOOR MOUNTED Ø 39MM ST/STEEL

PROJECT CODE: **HUKP-0105-11**

Circular pattern floor mounted door stop. Concealed fixing. Diameter 39mm / 52mm height. Black rubber buffered. Grade 304 Stainless Steel (Ø 32mm).

Concealed dowel screw fixings included for secure fix



Colours shown above correspond to finishes A- Page 9



DOOR STOP BUFFERED WALL MOUNTED Ø 25MM ST/STEEL

PROJECT CODE: **HUKP-0105-08**

Wall mounted door stop concealed fixing. 78mm projection / Ø 25mm. Buffered. Grade 304 Stainless Steel.

Concealed dowel screw fixings included for secure fix > Ø 50mm x 3mm circular rose also available to special order



Colours shown above correspond to finishes A- Page 9



DOOR STOP BUFFERED FLOOR MOUNTED Ø 44MM ST/STEEL

PROJECT CODE: **HUKP-0105-12**

Circular pattern floor mounted door stop. Floor screw fixing. Diameter 44.5mm / 25.5mm height. 5mm Black rubber buffered. Grade 304 Stainless Steel.

Dowel screw fixings included for secure fix Pin included to prevent door stop from rotating



Colours shown above correspond to finishes A- Page 9



DOOR STOP BUFFERED FLOOR MOUNTED Ø 60MM ST/STEEL

PROJECT CODE: **HUKP-0105-09**

FSB 3816 low pattern floor mounted door stop. Concealed fixing. Diameter 60mm / 25mm height. Buffered. Grade 304 Stainless Steel.

Concealed dowel screw fixings included for secure fix Pin supplied prevents door stop from rotating



Colours shown above correspond to finishes A- Page 9



FLOOR DOOR STOP STAINLESS STEEL Ø 38MM

PROJECT CODE: **HUKP-0105-29**

Concealed floor fixing. Body diameter 38mm Ø. Height 40mm. Stainless steel, black buffer.

Fixing bolt included



Colours shown above correspond to finishes A- Page 9





HEAVY DUTY DOOR STOP FLOOR MOUNTED Ø 60MM 316 ST/STEEL

PROJECT CODE: **HUKP-0105-13**

Heavy Duty external floor mounted door stop. Black polyurethane buffer. Diameter 60mm / 30mm height. Support plate 40mm diameter x 2.5mm. Grade 316 Stainless Steel for external applications.

Supplied with M8 Stainless Steel 6-lobe security tamper proof button head security bolt and M8 Raw-bolt a& "L" shaped wrench



Colours shown above correspond to finishes A- Page 9



COAT HOOK & DOOR STOP 304 STAINLESS STEEL 82MM / Ø19MM

PROJECT CODE: **HUKP-0105-17**

Buffered wall mounted door stop with coat hook pin. Concealed fixing. 82mm projection. Rose Ø 50mm / 8.5mm depth. Grade 304 Stainless Steel.

Supplied with fixings



Colours shown above correspond to finishes A- Page 9



DOOR HOLDER, MAGNETIC FLOOR MOUNTED Ø 50MM SATIN ST/STEEL

PROJECT CODE: **HUKP-0105-14**

Floor mounted door holder with spring loaded magnet. For interior doors (non-fire doors) for braking and holding door. Max door weight 60 kg. Release force 120N. Grade 304 Stainless Steel with 10mm black plastic height pad.

Concealed fixing
Supplied with both timber and glass door counterpieces Ø 26mm



Colours shown above correspond to finishes A- Page 9

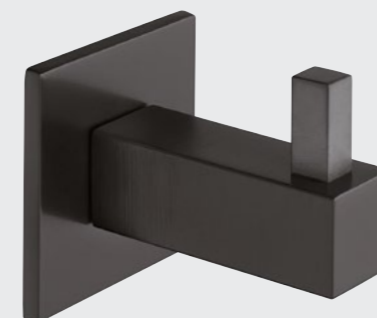

WARDROBE HOOK SQUARE DESIGN 304 ST/STEEL

PROJECT CODE: **HUKP-0105-18**

Square design wardrobe hook. Concealed fixing. Projection 42mm. Rose 35mm square / 3.0mm depth. Grade 304 Stainless Steel.

Supplied with fixings wood to metal dowel M6 x 38mm



Colours shown above correspond to finishes A- Page 9



DOOR HOLDER WITH CLAMP FLOOR MOUNTED 60MM SAA

PROJECT CODE: **HUKP-0105-15**

Floor mounted door stop with clamping mechanism. For interior doors (non-fire doors) for clamping the door. Max door weight 40kg. Aluminium with hard black rubber stop & counterpiece.

Concealed fixing - bottom door gap to be max 5mm
Supplied with timber door clamp counter-piece 20mm



Colours shown above correspond to finishes A- Page 9

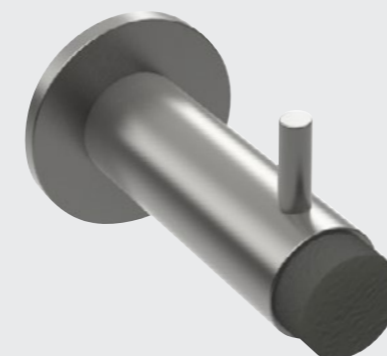

COAT HOOK BUFFERED 316 STAINLESS STEEL 16MM Ø

PROJECT CODE: **HUKP-0105-21**

Concealed fixing. 75mm projection. Buffered. Grade 316 Stainless Steel.

Concealed dowel screw fixings included for secure fix



Colours shown above correspond to finishes A- Page 9

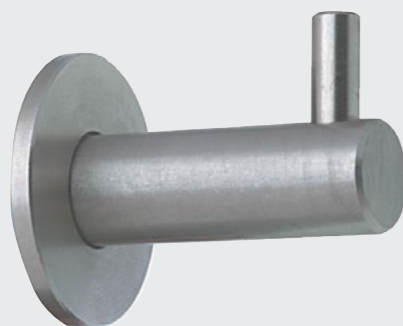

COAT HOOK CONCEAL FIX 316 STAINLESS STEEL 42MM / Ø14MM

PROJECT CODE: **HUKP-0105-16**

Concealed fixing. 42mm projection. Rose Ø35mm / 3mm depth. Grade 316 Stainless Steel.

Concealed dowel screw fixings included for secure fix



Colours shown above correspond to finishes A- Page 9



AUTOMATIC FLUSH BOLT SATIN STAINLESS STEEL

PROJECT CODE: **HUKP-0105-02**

Automatic locking and release for timber doors. Inactive leaf of double doors locked automatically when active leaf is closed into frame. See function*. Lower bolt head installed with roller for more positive contact.

Set includes: 2 x bolts and contact plates (nylon coated)
6 x space plated and set of fixing screws



Colours shown above correspond to finishes A- Page 9





DOOR VIEWER FD30 200° GLASS LENS & COVER Ø14MM

PROJECT CODE: **HUKP-0105-04**

Viewing angle: 200 degrees. Suitable for door thickness 35-55mm.
Body diameter: Ø14mm. Fire rated for FD30 doors. Push fit.

Manufactured from glass and solid brass as standard
Tested to BS EN 1634-1 for use on timber door sets
Suitable for 44mm thick for FD30 applications
Warrington Fire WF Test report 331560/E Issue 2



Colours shown above correspond to finishes A- Page 9



DOOR VIEWER FD60 200° GLASS LENS & COVER Ø14MM

PROJECT CODE: **HUKP-0105-05**

Viewing angle: 200 degrees. Suitable for door thickness 50-70mm. Body diameter: Ø14mm. Fire rated for FD60 doors Push fit.

Manufactured from glass and solid brass as standard
Tested to BS EN 1634-1 for use on timber door sets
Suitable for 54mm thick for FD60 applications
Warrington Fire WF Test report 331560/H Issue 2



Colours shown above correspond to finishes A- Page 9



StarTec



SECURITY DOOR GUARD CHAIN TYPE, FOR INWARD DOORS

PROJECT CODE: **HUKP-0105-06**

For inward opening flush timber doors. Cover plate and chain Stainless Steel.
Housing Zinc Alloy Includes 1 door guard, frame component & fixing set.

Stainless steel chain component



Colours shown above correspond to finishes A- Page 9



SECURITY DOOR GUARD RESTRICTOR, INWARD OPENING

PROJECT CODE: **HUKP-0105-07**

For inward opening flush timber doors. For guestroom doors. Housing Zinc Alloy. Includes 1 door guard, frame component & fixings.

Fixings included



Colours shown above correspond to finishes A- Page 9



FLUSH BOLT LEVER ACTION RADIUS SATIN ST/STEEL 20MM

PROJECT CODE: **HUKP-0105-03**

Lever action flush bolt radius ends in satin stainless steel. Lengths available in 150, 200, 305, 457, and 609mm. Available in square ends. Tested in accordance with BS EN 12051:1999. Tested to BS EN 1634:1.

Maximum depth of cut out - see fitting instructions
Flat shoot plate included



Colours shown above correspond to finishes A- Page 9



DUST EXCLUDING SOCKET BRASS BOLT SPRING LOADED Ø 11MM

PROJECT CODE: **HUKP-0105-28**

Floor mounted socket with spring loaded plunger. Application - for Ø 11mm shoot bolts. Brass material. Fixings included.



Colours shown above correspond to finishes A- Page 9



EASY CLEAN SOCKET 63MM ZINC DIECAST FOR Ø 11MM SHOOT SIZE

PROJECT CODE: **HUKP-0105-27**

Easy Clean socket for flush bolts. 63 x 20mm. To suit max. Ø 11 mm shoot size. Zinc Diecast. Fixings included.



Colours shown above correspond to finishes A- Page 9



EURO PROFILE CYLINDER PULL 88X44MM SATIN STAINLESS STEEL SSS

PROJECT CODE: **HHUKP-0105-01**

Euro profile face fix cylinder pull - 88 x 44 x 28mm
Projection 28mm in Stainless Steel, Satin finish.

Face fixed - supplied with matching wood screws.





FIRE SIGNAGE FDKS Ø 76MM BLUE/WHITE ON ST/STEEL D/SCK

PROJECT CODE: **HUKP-0105-24**

76mm diameter - Fire Door Keep Shut. Blue / White disc on satin stainless steel edge. Conforms to BS 5499:4 2000 and ISO7010. Stainless Steel.

Drilled and Countersunk - matching fixings supplied
Available as self-adhesive fix



Colours shown above correspond to finishes A- Page 9



FDKS SIGN - VERTICAL RADIUS ENDS BLUE/WHITE / 3M ADHESIVE

PROJECT CODE: **HUKP-0105-31**

Floor mounted door stop with clamping mechanism. For interior doors (non-fire doors) for clamping the door. Max door weight 40kg. Aluminium with hard black rubber stop & counterpiece.

150 x 13 x 1.6mm Adhesive Fire Door Keep Shut
Blue Laminate/Full Rad Ends/3M Engraved Vertically mounted



Blue and White



FIRE SIGNAGE FDKL Ø 76MM BLUE/WHITE ON ST/STEEL D/SCK

PROJECT CODE: **HUKP-0105-25**

76mm diameter - Fire Door Keep Locked. Blue / White disc on satin stainless steel edge. Conforms to BS 5499:4 2000 and ISO7010. Stainless Steel.

Drilled and Countersunk - matching fixings supplied
Available as self-adhesive fix



Colours shown above correspond to finishes B- Page 17



FDKL SIGN - VERTICAL RADIUS ENDS BLUE/WHITE / 3M ADHESIVE

PROJECT CODE: **HUKP-0105-32**

150 x 13 x 1.6mm Adhesive Fire Door Keep Locked. Blue Laminate/Full Rad Ends/3M Engraved Vertically mounted.

Self- Adhesive



Blue and White



FIRE SIGNAGE AFDKC Ø 76MM BLUE/WHITE ON ST/STEEL D/SCK

PROJECT CODE: **HUKP-0105-26**

76mm diameter - Automatic Fire Door Keep Clear. Blue / White disc on satin stainless steel edge Conforms to BS 5499:4 2000 and ISO7010 Stainless Steel.

Drilled and Countersunk - matching fixings supplied
Available as self-adhesive fix



Colours shown above correspond to finishes B- Page 17



FIRE ESCAPE KEEP CLEAR Ø 76MM X 1MM PLASTIC BLUE / WHITE

PROJECT CODE: **HUKP-0105-33**

Mandatory sign "Fire Escape Keep Clear" Ø 76mm x 1mm conforms to BS 5499. Blue and white on rigid plastic.

Drilled for screw fixing - not included



Blue and White



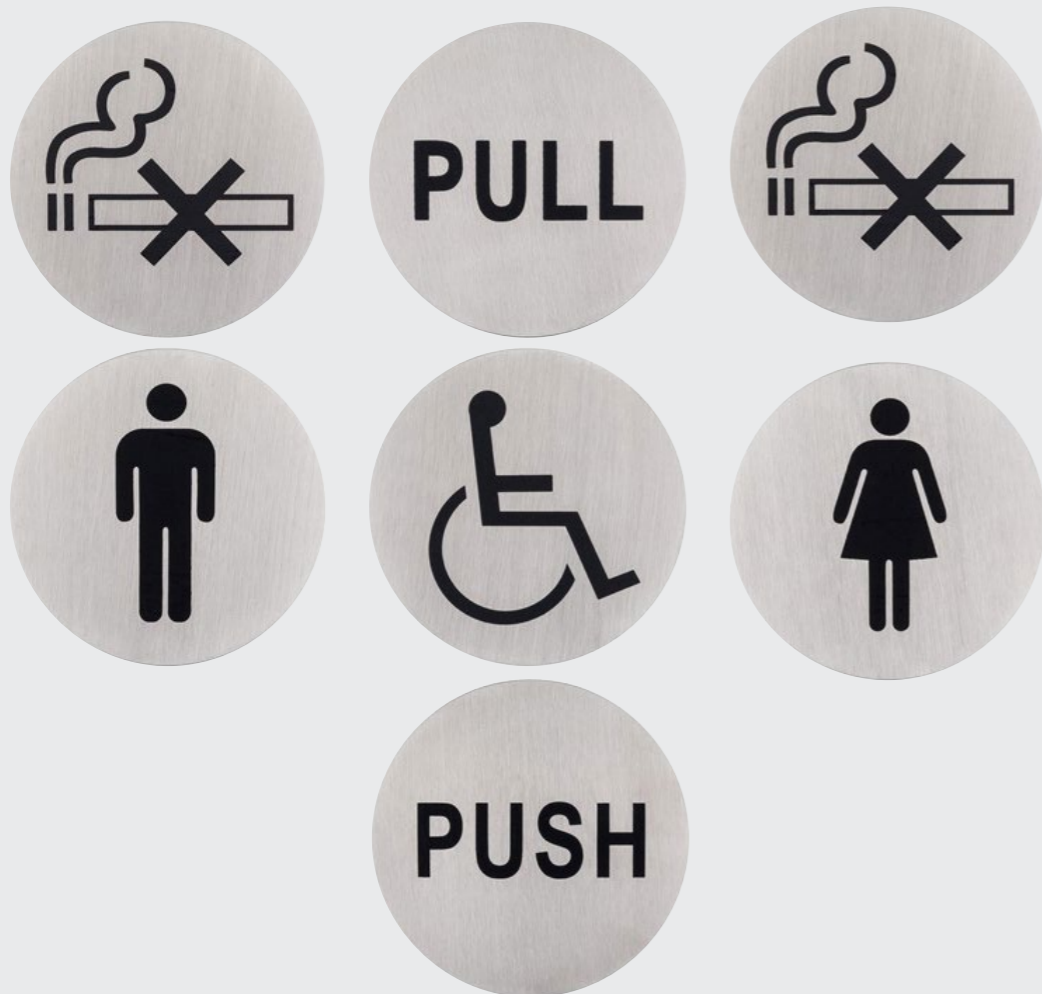
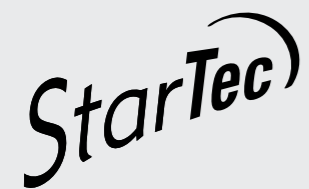

STARTEC GRAPHIC SIGNS Ø 75MM 304 ST/STEEL SELF-ADHESIVE

PROJECT CODE: **HUKP-0105-19**

StarTec gender and graphic symbols. Diameter 75mm / thickness 1mm. Gender available: Male / Female / Male + Female (shown). Graphic signs available: Disabled / No Smoking / Push / Pull. Grade 304 Stainless Steel - Black infill.

Self-adhesive



Colours shown above correspond to finishes B- Page 17



STARTEC APARTMENT NUMERALS 120MM / 92MM SSS

PROJECT CODE: **HUKP-0105-20**

StarTec Apartment numerals 0-9. StarTec Apartment letters (a to d). Height: 120mm (numeral) and 92.5mm (a + c) 117.1mm (b+d). Grade 304 Stainless Steel - Black infill.

Reverse screw fixing set supplied



Colours shown above correspond to finishes B- Page 17

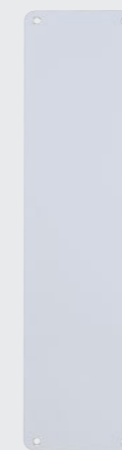

PUSH PLATE RADIUS CORNERS 304 GRADE ST/STEEL 1.5MM D/CSNK

PROJECT CODE: **HUKP-0105-22**

Push plate available from 300mm H to 2000mm Height. Available in radius and square corners. Bespoke sizes available with cut outs for euro cylinders, bathroom turn sets and fire signage with bespoke engraving.

Drilled and countersunk
Also available as self-adhesive fix



Colours shown above correspond to finishes B- Page 17

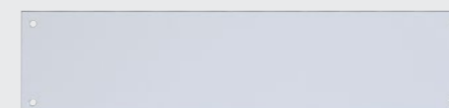

KICKING PLATE SQ & RADIUS 304 GRADE ST/STEEL 1.5MM D/CSNK

PROJECT CODE: **HUKP-0105-23**

Kick plate available from 400mm to 1200mm Length. Available in square and radius corners. Bespoke sizes available with cut outs for euro cylinders, bathroom turn sets and fire signage with bespoke engraving.

Drilled and countersunk
Also available as self-adhesive fix



Colours shown above correspond to finishes B- Page 17





HÄFELE



0800 171 2907



hafele.co.uk/projects



estimating@hafele.co.uk

Häfele UK Ltd, Brownsover Road, Swift Valley Industrial Estate, Rugby, Warwickshire CV21 1RD