

HÄFELE

# FURNITURE HANDLES

INCLUDING PROFILES FOR HANDLE FREE APPLICATIONS

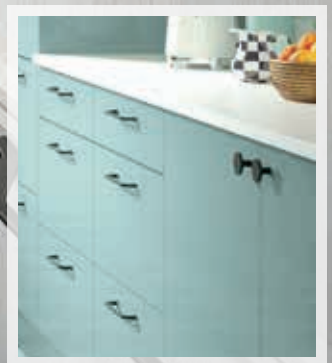
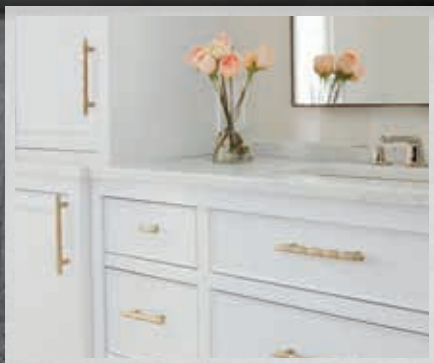

OCTOBER 2021 EDITION

# Contents

Furniture Handles & Profiles for Handle Free Applications

**At a Glance**

Page

**6**

AT A GLANCE

**Kitchen Applications**

Page

**42**

KITCHEN APPLICATIONS

- Bar handles ..... 42
- D handles ..... 54
- Pull handles ..... 67
- Bow handles ..... 108
- Cup handles ..... 126
- Knobs ..... 156
- Pendant handles ..... 184
- Trim/pull handles ..... 188
- Inset handles ..... 204

**Bedroom Applications**

Page

**216**

BEDROOM APPLICATIONS

- Bar handles ..... 216
- D handles ..... 220
- Pull handles ..... 222
- Bow handles ..... 239
- Cup handles ..... 246
- Knobs ..... 258
- Pendant handles ..... 268
- Trim/pull handles ..... 270
- Inset handles ..... 274

**Bathroom Applications**

Page

**276**

BATHROOM APPLICATIONS

- Bar handles ..... 276
- D handles ..... 281
- Pull handles ..... 284
- Bow handles ..... 302
- Cup handles ..... 308
- Knobs ..... 318
- Trim/pull handles ..... 328

**Handle Free Applications**

Page

**334**

HANDLE FREE APPLICATIONS

**GOLA profiles**

- Overview ..... 334
- System selection ..... 336
- System A ..... 339
- Original System B ..... 340
- Original System C ..... 341
- System B Plus ..... 342
- System C Plus ..... 343
- System D ..... 344
- System E ..... 346
- Plinth panels ..... 348

**Installation & Display**

Page

**350**

INSTALLATION & DISPLAY

**Installation**

- Tools/Jigs ..... 350
- Care & maintenance.. 352
- Handle screws ..... 353

**Display**

- Handle display boards..... 352

# WELCOME

Whatever style kitchen you are creating, from industrial to traditional country, we have the handles for you. With over 2000 handles in our range, you can browse for more information knowing Häfele have got you covered. And thank you for choosing Häfele as your business partner, if you need any help, please get in touch. We are always on hand to help.



**CRAIG CHAMBERS**  
REGIONAL DIRECTOR  
WESTERN EUROPE

A handwritten signature in black ink, appearing to read 'CCD', written over a horizontal line.

## WHY HÄFELE?

**A worldwide respected name in the industry, Häfele has been helping people make the most of their homes for nearly 100 years.**

We work closely with the leading brands in the industry to bring you the highest quality products and the latest design innovations, all backed by our expertise and commitment to excellent customer service.

FIND US ON



# HANDLE COLOUR GUIDE

## BLACK

Black handles are a staple for contemporary and modern kitchens. When using brilliant white doors like the Aspekt Skye in kitchen design, a matt black knob or pull handle would contrast perfectly. See our most popular black handles here:

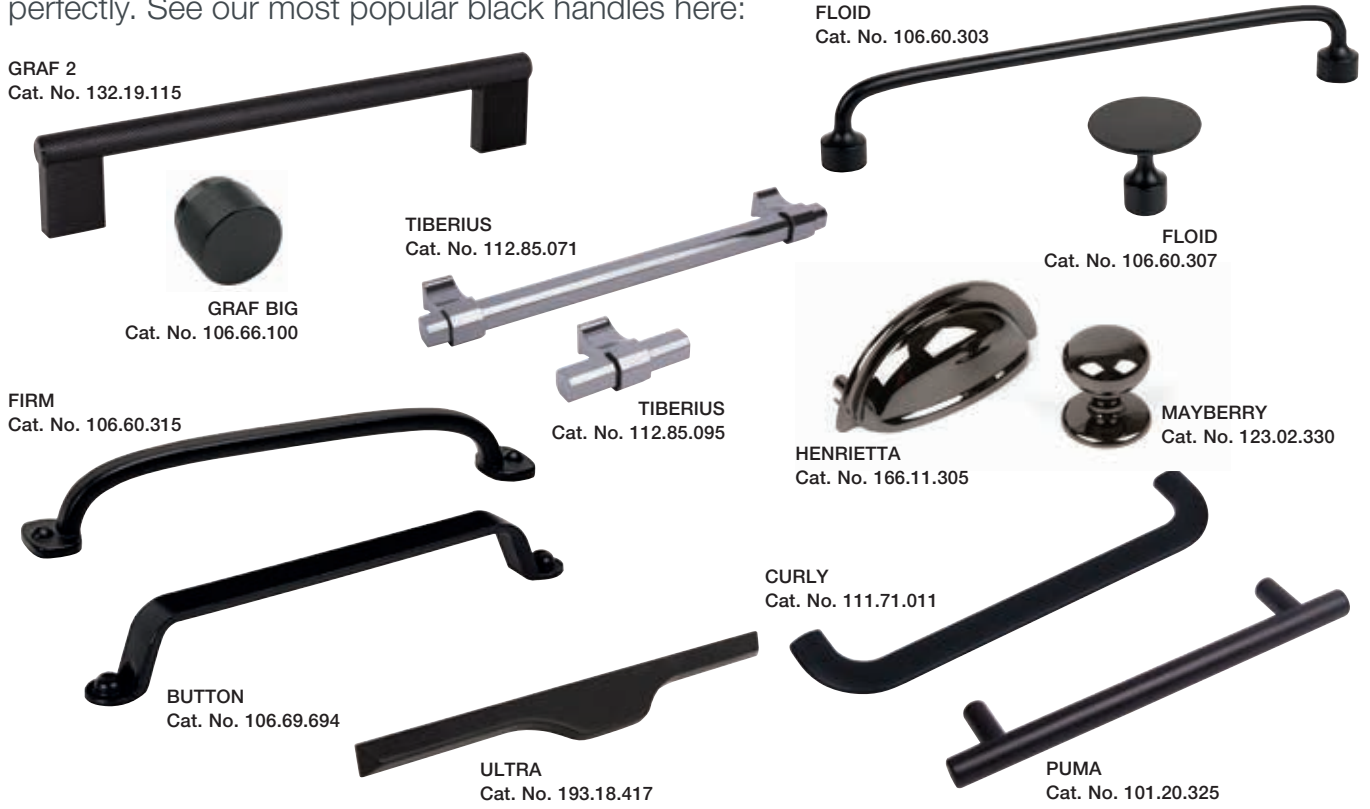

## GOLD & BRASS

Gold and brass finishes are some of the most popular amongst kitchen designers. Gold is a versatile colour that can be used in a variety of ways to complete the perfect kitchen style. Brass is becoming increasingly popular because of the finish it provides in a dark toned kitchen. Our midnight blue York slab door is the perfect partner for either brass or gold handles. Browse our gold and brass handle range throughout the brochure with our best sellers here:

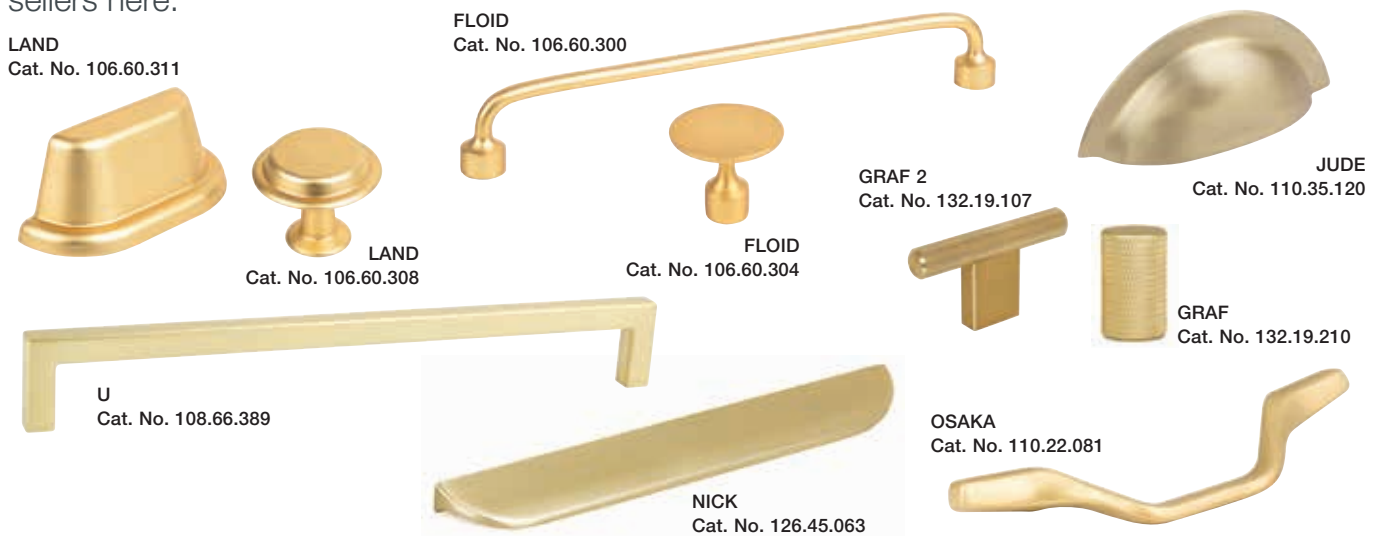

## COPPER

Like gold, copper is very versatile, and like brass matches perfectly with darker colours. A brushed brass finish in a kitchen can also create a stunning impact-finish to those seeking a country or traditional look.

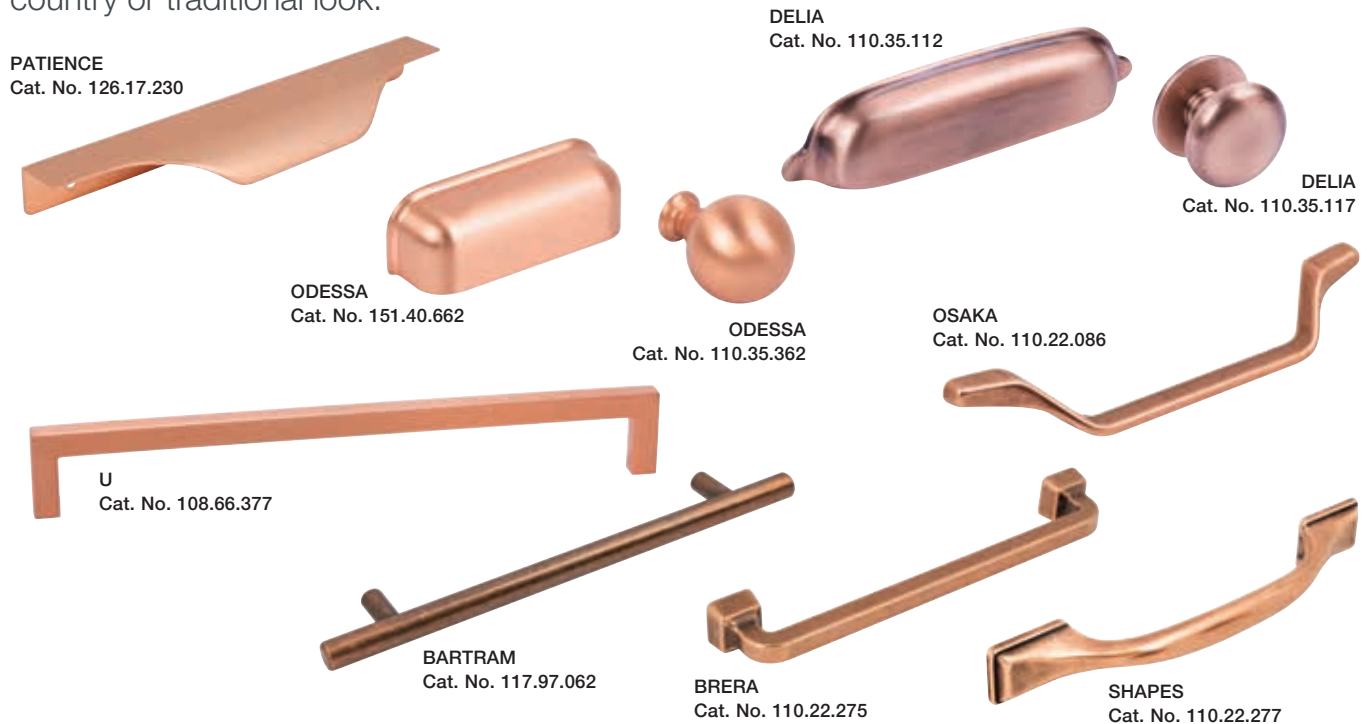

## CHROME

Chrome handles are ideal in a modern looking battleship grey kitchen as well as a more traditional white or cream styled kitchen. When used correctly chrome finishes provide a beautiful final touch to the most popular room in the house.



# Finishes

Metal finishes		Wood finishes	
 Aluminium coloured	 Brushed stainless steel	 Polished chrome	 Antique oak stained and lacquered
 Aged brass effect	 Cast iron	 Polished nickel	 Beech, unfinished
 Antique brass	 Dark brass	 Satin brass	 Clear lacquered oak
 Antique bronze	 Golden champagne	 Silver coloured	 Light oak stained and lacquered
 Antique copper	 Graphite	 Stainless steel effect	 Maple, unfinished
 Antique pewter	 Magnolia	 Textured black	 Oak, unfinished
 Antique tin	 Matt anthracite	 White	 Oak lacquered
 Black	 Matt black		 Pine, unfinished
 Black nickel	 Matt brass		 Smoked oak
 Bronzed and brushed	 Matt chrome		 Walnut
 Brushed black	 Matt nickel		
 Brushed brass	 Matt white		
 Brushed copper	 Natural iron		
 Brushed gold	 Oil rubbed bronze		
 Brushed grey	 Pewter		
 Brushed nickel	 Polished brass		

## Key to logos



**Fixing screws are included -**



**Fixing required -**

Denotes the size and type of fixings required



**Exclusive to Häfele UK -**

These handles are only available from Häfele UK. These are exceptionally innovative designs made of quality materials



**Made in Great Britain -**

These handles are designed and manufactured in the UK



**Dimension Tolerances -**

Due to the manufacturing processes of certain materials these handles are more subject to variations in dimensions and finish

## EASY TO ORDER

Designed around your needs, to make ordering as simple as possible. To place an order, please login to your account at [hafele.co.uk](http://hafele.co.uk), available 24/7.

If you would like further information about a product before ordering, please contact our Advice and Sales team on free phone **0800 171 2909**. For a more personal touch, please speak to your Area Sales Manager. We will happily take your order online or by phone.

### HOW TO ORDER



Free Phone:  
**0800 171 2909**



Email:  
**info@hafele.co.uk**



Order Online 24/7:  
**hafele.co.uk**

## HÄFELE TO ORDER SERVICE

Häfele to Order (HtoO) is designed to save you time, minimise order errors and improve efficiency when ordering products. With HtoO, you can specify exactly what you need, the quantity and finish, with zero wastage. The products are then cut, assembled, packaged and delivered to where you need them.



Our Gola Profile range and matching plinths, found on pages 334-349, are the perfect products for ordering with HtoO.

For more information see [www.hafele.co.uk/hafele-to-order](http://www.hafele.co.uk/hafele-to-order)

### ORDER IN 3 EASY STEPS

1



COMPLETE THE  
ORDER FORM SO WE  
CAN CONTACT YOU

2



REVIEW AND  
ACCEPT YOUR  
ORDER QUOTE

3



RECEIVE YOUR  
ORDER TO YOUR  
SPECIFICATION

## CARE & MAINTENANCE

We advocate the use of a dry cloth only to clean handles. Please do not under any circumstances use any form of metal cleaner or aerosol spray.

Our microfibre cloth is perfect for cleaning all types of handles and knobs without using chemicals that could damage the surface finish.



Microfibre cloth  
Cat. No. 007.32.135,  
shown on page 352



BARKSTON



K Bed Bath

Pages 42, 217, 277

BARRINGTON



K

Page 43

BARNABUS



K

Page 43

MELINA



K

Page 44

ALICE



K

Page 44

BELLA



K Bed Bath

Pages 44, 217, 277

BESWICK



K

Page 46

INDIA



K

Page 45



BARTRAM

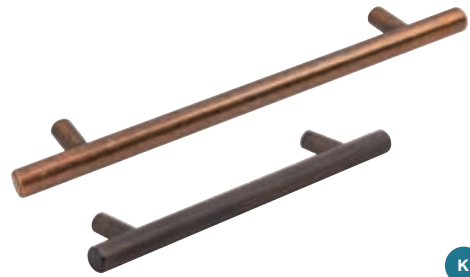

K Bed Bath

Pages 45, 216, 276

PUMA



K Bed Bath

Pages 47, xx, xx

PIMLICO



K Bed

Pages 46, 218



Häfele recommended applications - Kitchen **K**

Bedroom **Bed**

Bathroom **Bath**



TIBERIUS

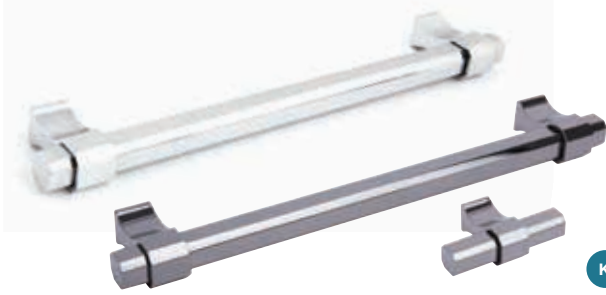

K Bath

Pages 47, 278



AT A GLANCE

KITCHEN APPLICATIONS

CARRIONE



K Bath

Pages 48, 279

BEDROOM APPLICATIONS

ST. VINCENT



K Bed Bath

Pages 49, 219, 280

BATHROOM APPLICATIONS

TILAA



K

Page 50

VENUS



K

Page 51



HANDLE FREE APPLICATIONS

INSTALLATION & DISPLAY

Häfele recommended applications - Kitchen

K

Bedroom

Bed

Bathroom

Bath

BAYSWATER

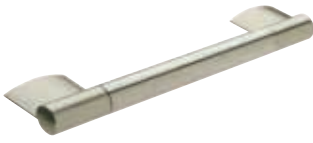

K

Page 53

ORLANA



K

Page 53

BOROS



K

Page 53

CARE & MAINTENANCE



Page 352



BOSTON



K Bed Bath

Pages 54, 220, 281

BEULAH



K

Page 54

CHELSEA



K

Page 55

GIGI



K

Page 55

LYDIATE



K

Page 55

LAUREL



K

Page 56

NUGENT



K

Page 56

INSTALLATION TOOLS

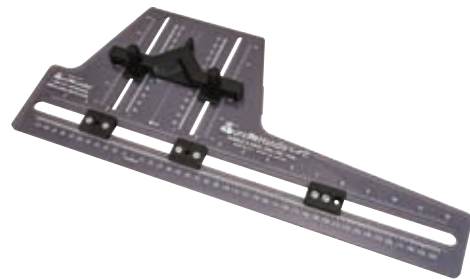

Pages 350-351

Häfele recommended applications - Kitchen

K

Bedroom

Bed

Bathroom

Bath

MANDALAY



K

Page 56

D HANDLE, Ø 10 MM



K

Page 57

D HANDLE, Ø 10 MM



K

Page 57

D HANDLE, Ø 10 MM



K

Page 57

D HANDLE, Ø 8 MM

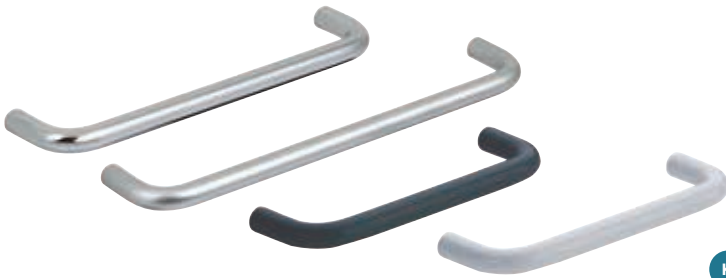

K

Page 58

D HANDLE, Ø 8 MM



K

Page 58

MUSGRAVE



K

Page 59

CONWAY



K

Page 59

ARGYLL



K

Page 59

LAMA



K

Page 60



Häfele recommended applications - Kitchen

K

Bedroom

Bed

Bathroom

Bath

FURNITURE HANDLES 2021, © Häfele U.K. Ltd 2021. Dimensional data not binding. We reserve the right to alter specifications without notice.

DUKE



K

Page 61

LEOPOLD



K

Page 61

PEMBRIDGE



K

Page 62

LYLE



K

Page 63

FACTORY



K

Page 64

BUTTON



K

Page 65

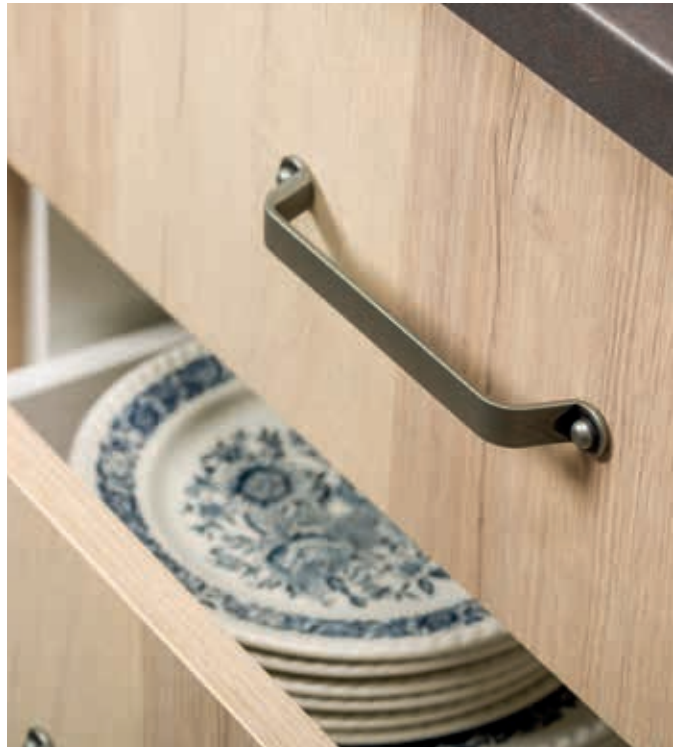

OSAKA



K Bed Bath

Pages 66, 221, 282



Häfele recommended applications - Kitchen **K**

Bedroom **Bed**

Bathroom **Bath**

PUTNEY



**K**  
Page 67



M4 HANDLE SCREWS



Page 353

ARVE



**K**  
Page 68

MALVAN



**K**  
Page 68

BIOKO



**K**  
Page 68

BRONTE



**K**  
Page 69

CARE & MAINTENANCE



Page 352

ENZA



**K**  
Page 69

KESWICK



**K**  
Page 69

MORGAN



**K**  
Page 70

LINCOLN



**K**  
Page 71



LARISSA



BALTIMORE

JUTLAND



**K**  
Page 71

LUELLA



**K**  
Page 71



**K**  
Page 72



**K Bath**  
Pages 72, 287

HARGRAVE



**K**  
Page 72

Häfele recommended applications - Kitchen **K**

Bedroom **Bed**

Bathroom **Bath**

## METROPOLIS



**K Bath**  
Pages 74-75, 284-285



## PLANE



**K**  
Page 76

## LEVEL



**K Bed**  
Pages 77, 222

## OASI



**K Bath**  
Pages 78, 286

## JAZZ



**K**  
Page 79



## CEYLON



**K**  
Page 81

## CURLY



**K Bath**  
Pages 81, 287

## SWING



**K**  
Page 80

## TONDA



**K**  
Page 81

## CARE & MAINTENANCE



Page 352

Häfele recommended applications - Kitchen **K**

Bedroom **Bed**

Bathroom **Bath**

ADDA



K

Page 82

CONTACT



K

Page 82



AT A GLANCE

KITCHEN APPLICATIONS

BEDROOM APPLICATIONS

BATHROOM APPLICATIONS

HANDLE FREE APPLICATIONS

INSTALLATION & DISPLAY



OVAL



K

Bed

Pages 82, 223

M4 HANDLE SCREWS



Page 353

EROS



K

Page 83

ULTRA



K

Bath

Pages 83, 287

TWIST



K

Bed

Pages 83, 224

INSTALLATION TOOLS



Pages 350-351

Häfele recommended applications - Kitchen **K**

Bedroom **Bed**

Bathroom **Bath**

## GRAF 2



K Bed Bath

Pages 84-85, 226-227, 288-289



## GRAF

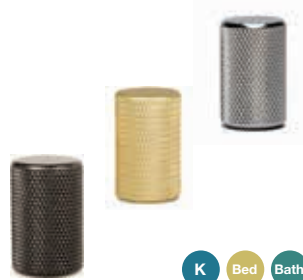

K Bed Bath

Pages 85, 227, 289

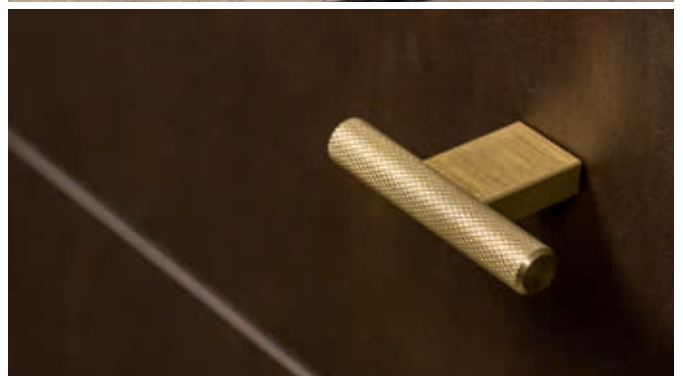

## GRAF BIG



K Bed Bath

Pages 86, 228, 290



Häfele recommended applications - Kitchen

K

Bedroom

Bed

Bathroom

Bath



FLOID



K

Page 87



FIRM



K

Page 88



M4 HANDLE SCREWS



Page 353



TARVOS



K Bed Bath

Pages 89, 229, 291



ENCANTO



K Bed Bath

Pages 89, 229, 291

RHEA



K Bed Bath

Pages 89, 229, 291

Häfele recommended applications - Kitchen **K**

Bedroom **Bed**

Bathroom **Bath**

C

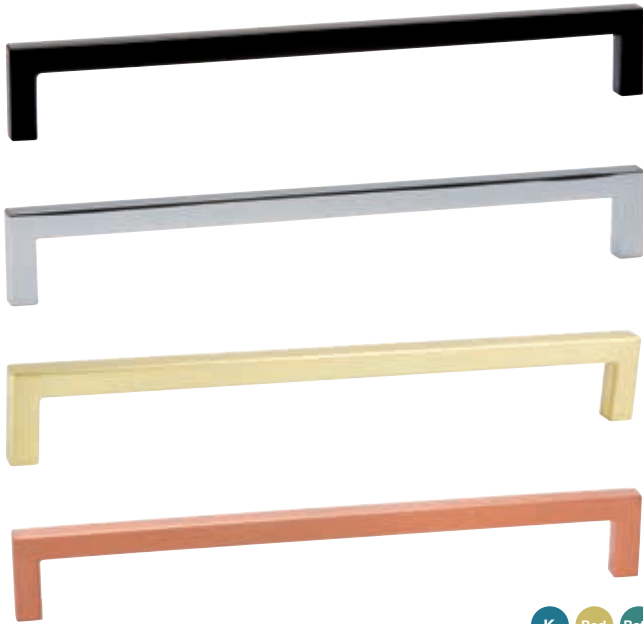

K Bed Bath

Pages 90, 230, 292



ESTE

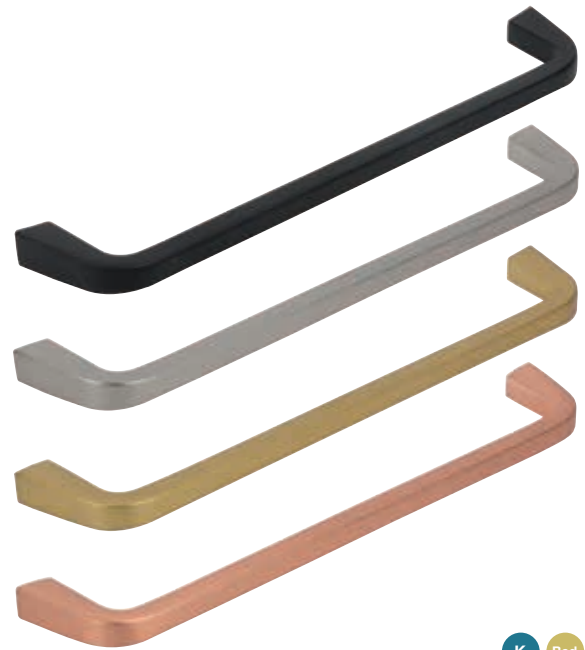

K Bed Bath

Pages 91, 231, 293

OLYMPIA



K

Page 92

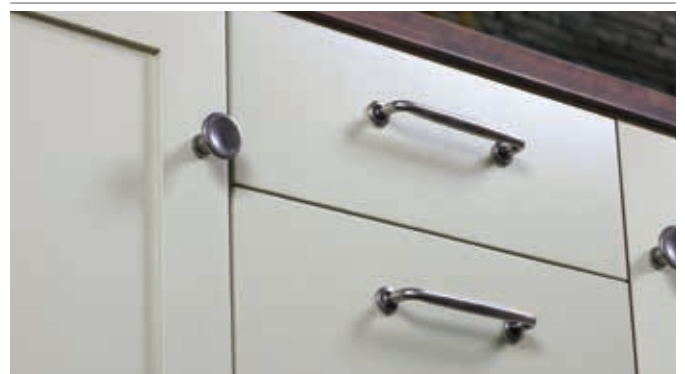

Häfele recommended applications - Kitchen

K

Bedroom

Bed

Bathroom

Bath

## MAYFAIR



**K**  
Page 93

## WARWICK



**K**  
Page 93

## HERITAGE



**K**  
Page 94

## SALVADOR



**K**  
Page 94

## BRERA



**K Bath**  
Pages 95, 295

## SHAPES



**K**  
Page 95

## INSTALLATION TOOLS



Pages 350-351

## THEODORE



**K**  
Page 96



## BURBRIDGE



**K Bed Bath**  
Pages 97, 232, 294

Häfele recommended applications - Kitchen **K**

Bedroom **Bed**

Bathroom **Bath**

## DEVON



K

Page 98

## EMERSON



K

Bed

Bath

Pages 98, 238, 297

## HARRINGTON



K

Bath

Pages 98, 297

## SAFFRON



K

Page 98

## CALEIDO



K

Bath

Pages 99, 296



## COLIBRI



K

Page 100

## RIO



K

Page 101

## FALSTAFF



K

Page 101

## MONTROSE



K

Bath

Pages 101, 297

## BLANCO



K

Bed

Pages 102, 233

## NOIR



K

Bed

Pages 102, 233

## DOMINO



K

Bed

Pages 102, 233

Häfele recommended applications - Kitchen **K**

Bedroom **Bed**

Bathroom **Bath**

## CRYSTAL



K Bed Bath

Pages 103, 234, 298

## GLACIO



K Bed Bath

Pages 104, 235, 299

## BYRON



K Bed Bath

Pages 105, 236, 300



## GLITTER

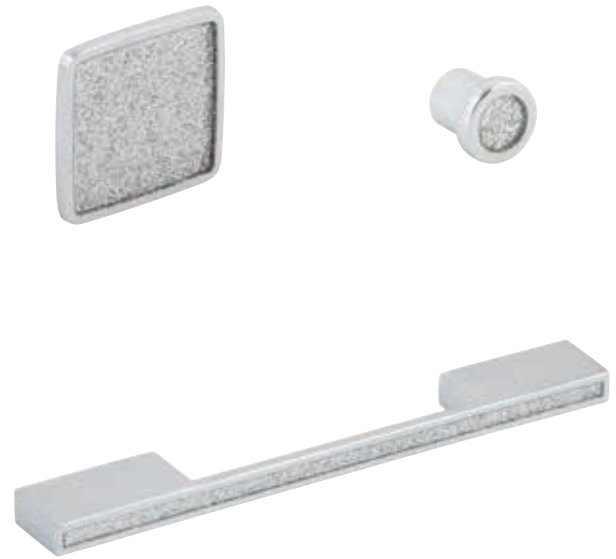

K Bed

Pages 106, 237

## DISCO



K Bed

Pages 107, 238

## DOTTY



K

Page 108

## DIMPLE



K Bed Bath

Pages 108, 239, 302

## ANTROBUS



K

Page 109

## QUIGLEY



K Bed Bath

Pages 109, 240, 303

## OCTAVIA



K Bath

Pages 109, 303

## LEWIS



K

Page 110

## BELMONT



K

Page 110

Häfele recommended applications - Kitchen **K**

Bedroom **Bed**

Bathroom **Bath**

CICERO



K Bath

Pages 110, 304

DARIA



K

Page 111

JACKSON



K

Page 111

CHISWICK



K Bed Bath

Pages 111, 240, 303

TARA



K Bed

Pages 112, 240

EMILY



K

Page 112

SOPHIA



K Bed

Pages 113, 241

SILAS



K Bed

Pages 113, 241

TAVISTOCK



K Bed Bath

Pages 114, 241, 304

FLORENCE



K

Page 114

INSTALLATION TOOLS



Pages 350-351

MELBURY



K

Page 114

MANILIA



K

Page 115

SABINE



K

Page 115

GRACE



K

Page 116

AUBREY



K Bed

Pages 116, 242

REMUS



K

Page 116

KAYLA



K

Page 117

Häfele recommended applications - Kitchen **K**

Bedroom **Bed**

Bathroom **Bath**

LOGAN



K

Page 117

ARCO



K Bed

Pages 118, 243

INDIGO



K Bed Bath

Pages 119, 244, 305

BRADLEY



K

Page 117

BOW HANDLE

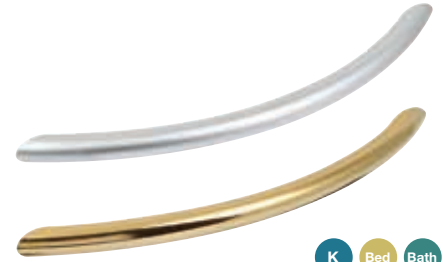

K Bed Bath

Pages 119, 244, 305

CEDAR



K

Page 120

CLIFTON



K Bed Bath

Pages 120, 244, 305

ELMER



K

Page 121

M4 HANDLE SCREWS



Page 353

HUDSON



K Bath

Pages 121, 306

CORDELIA



K Bed Bath

Pages 121, 245, 307

Häfele recommended applications - Kitchen

K

Bedroom

Bed

Bathroom

Bath

RAVIOLO



K

Page 122

HENLEY



K Bed Bath

Pages 123, 242, 304



FABIAN



K

Page 124

NORFOLK



K

Page 124

SHERWOOD



K

Page 124

TAPER



K

Page 125

KNIGHTSBRIDGE



K Bed

Pages 126, 246

KNIGHTSBRIDGE



K Bed

Pages 126, 246

ROCHDALE



K

Page 127

Häfele recommended applications - Kitchen

K

Bedroom

Bed

Bathroom

Bath



HENRIETTA



K Bed Bath

Pages 128, 247, 308



ARIEL



K Bed Bath

Pages 129, 248, 309

BLACK NICKEL



K Bed Bath

Pages 128, 133, 247, 308

ODESSA



K Bed Bath

Pages 130-131, 250-251, 310-311

RESTORATION



K

Page 132



WILTON



K

Page 132

MAYBERRY



K

Page 133

AUGUSTA



K Bed

Pages 134-135, 252-253

Häfele recommended applications - Kitchen **K**

Bedroom **Bed**

Bathroom **Bath**

FURNITURE HANDLES 2021, © Häfele U.K. Ltd 2021. Dimensional data not binding. We reserve the right to alter specifications without notice.

SMOOTH



**K**  
Page 136



BEAULIEU



**K**  
Page 137

BOLD



**K**  
Page 138



KANE



**K** **Bed** **Bath**  
Pages 139, 254, 316

DELIA



**K** **Bath**  
Pages 140, 312

JUDE



**K** **Bath**  
Pages 141, 313

Häfele recommended applications - Kitchen **K** Bedroom **Bed** Bathroom **Bath**

LAMONT



K

Page 142-143



AT A GLANCE

KITCHEN APPLICATIONS

BEDROOM APPLICATIONS

BATHROOM APPLICATIONS

HANDLE FREE APPLICATIONS

INSTALLATION & DISPLAY



CONWY

CONWY



K

Page 148



K

Page 148

MULBERRY



K

Bath

Pages 144-145, 314-315

IRONBRIDGE & RIO

IRONBRIDGE & CONWY

QUESLETT



K

Pages 146, 101



K

Pages 147, 148



K

Page 150

Häfele recommended applications - Kitchen

K

Bedroom

Bed

Bathroom

Bath



LAND



K

Page 151



CRAWFORD



K Bed Bath

Pages 153, 255, 317

Häfele recommended applications - Kitchen K

Bedroom Bed

Bathroom Bath



COTSWOLD



Pages 154, 256



COTSWOLD

COTSWOLD

COTSWOLD



Pages 155, 257



Pages 155, 257



Pages 155, 257

EGG TIMER

BINX

LEO

ORSON



Pages 156, 318



Page 156



Page 156



Page 156

BEUVRON

CORMOR

DEXTER

AMBER



Page 157



Page 157



Page 157



Pages 158, 258, 318

Häfele recommended applications - Kitchen



Bedroom



Bathroom



LARA



K

Page 158

FLYNN



K

Page 158

OVAL



K

Page 159

ORIEL



K Bed Bath

Pages 159, 258, 319

CASSIUS



K

Page 159

AMELIA



K Bath

Pages 160, 319

ASPEN



K

Page 160

BIANCA



K

Page 160

CLEO



K

Page 161

COCO



K

Page 161

FLOYD



K

Page 161

RUGBY



K

Page 162

CLAYTON



K

Page 162

CORRINE



K

Page 162

GROSVENOR



K Bed

Pages 163, 258

M4 HANDLE SCREWS



Page 353

ROCHER



K Bed Bath

Pages 164, 260, 320

BALLEY



K Bath

Pages 164, 320

SULA



K

Page 164

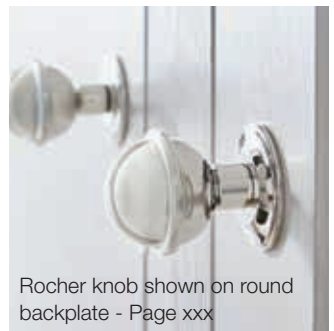

Rocher knob shown on round backplate - Page xxx

Häfele recommended applications - Kitchen **K**

Bedroom **Bed**

Bathroom **Bath**

JUPITER



**K** **Bed** **Bath**  
Pages 166, 262, 318

KENDRICK



**K**  
Page 166

VICTORIA



**K** **Bed**  
Pages 167, 262

CALVIN



**K**  
Page 167

IRIS



**K**  
Page 167

CROSS GRAIN



END GRAIN



TURNED - END GRAIN



**K**  
Page 169

VICTORIAN - CROSS GRAIN



**K**  
Page 170

TURNED - END GRAIN



**K** **Bed**  
Pages 168, 263

TURNED - END GRAIN



**K**  
Page 169

CROSS GRAIN



**K**  
Page 168

TURNED - END GRAIN



**K**  
Page 169

TURNED - END GRAIN



**K**  
Page 170

CROSS GRAIN



**K**  
Page 170

WOOD TREATMENTS



Visit [hafele.co.uk](http://hafele.co.uk)

Häfele recommended applications - Kitchen **K** Bedroom **Bed** Bathroom **Bath**



YOYO



K

Page 171

CADOGAN

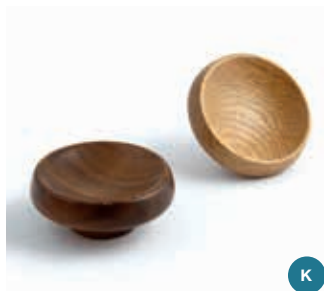

K

Page 171



SHAKER



K

Page 171

HARLEY



K Bed Bath

Pages 172, 264, 322

DIAMOND

PRIMROSE



K Bed

Pages 172, 264



K Bed

Pages 172, 264



Häfele recommended applications - Kitchen

K

Bedroom

Bed

Bathroom

Bath



ESTE & COMO



Pages 91, 231, 293



COMO



**K** **Bed** **Bath**  
Pages 173, 265, 323

INSTALLATION TOOLS

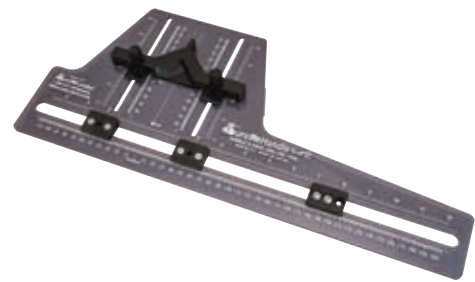

Pages 350-351

PEARL



**K** **Bed** **Bath**  
Pages 172, 264, 322

ACER



**K** **Bath**  
Pages 174, 324

CYRUS



**K**  
Page 174

JONQUIL



**K**  
Page 174

ACACIA



**K** **Bath**  
Pages 174, 324

CHLOEU



**K** **Bed** **Bath**  
Pages 175, 266, 325

KEW



**K** **Bed** **Bath**  
Pages 175, 266, 325

CONSTANCE



**K** **Bed** **Bath**  
Pages 175, 266, 325

Häfele recommended applications - **Kitchen** **K** **Bedroom** **Bed** **Bathroom** **Bath**

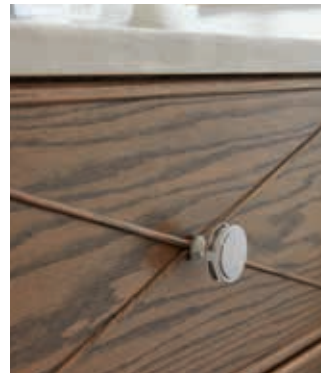

OBERON



K Bed Bath

Pages 176, 267, 326

CORBUSIER



K Bath

Pages 177, 327

CARE & MAINTENANCE



Page 352

LUCA



K

Page 177

LUCA



K

Page 177

GEMINI



K

Page 178

ANGUS



K Bath

Pages 178, 327

ALBANO



K

Page 180

CARTON



K

Page 180

CHESTER



K

Page 180

HELENE



K

Page 180

POLKA



K

Page 181

SORENTO



K

Page 181

Häfele recommended applications - Kitchen

K

Bedroom

Bed

Bathroom

Bath

TAMARA



K

Page 181

TAURION



K

Page 181

EDEN



K

Page 182

BRUNSWICK



K

Page 182

BUXTON



K

Page 182

SAVANNAH



K

Page 183

SYON



K

Page 183

ARCADIA



K

Page 183

CAXTON



K

Page 186

CAXTON



K

Page 186

ARGENTON



K

Page 187

RISLE



K

Page 187

TWISTER



K Bed

Pages 184-185, 268-269



Häfele recommended applications - Kitchen **K**

Bedroom **Bed**

Bathroom **Bath**

CURVE



K

Page 188

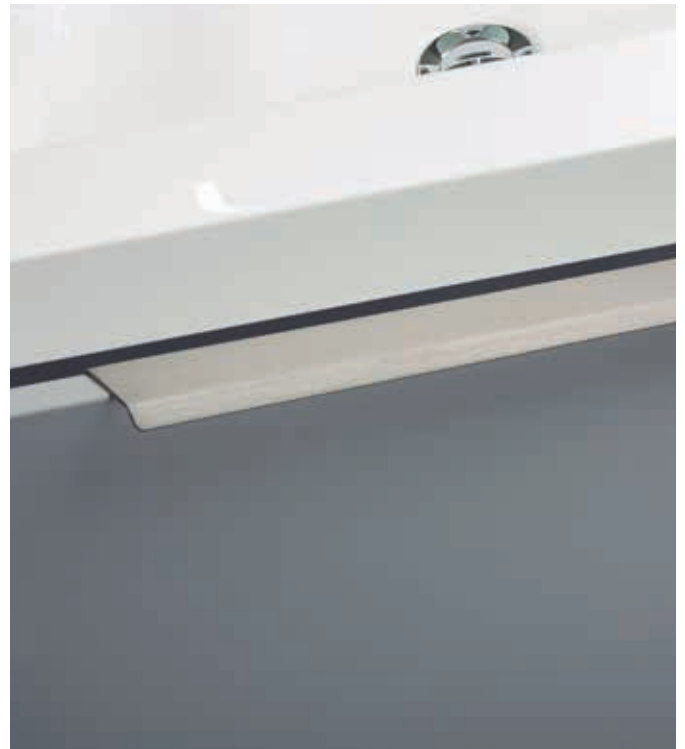

MADDOX



K

Page 189

ELLA



K

Page 189

QUINN



K

Page 189

FINN



K

Page 190

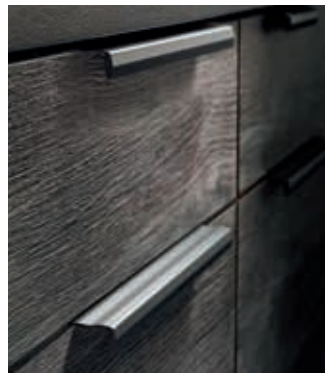

LINE



K Bed Bath

Pages 190, 270, 328

LISTER



K Bed Bath

Pages 190, 270, 328

CALAVON



K

Page 192

ONA



K

Page 191



PORTOBELLO



K

Page 192

Häfele recommended applications - Kitchen **K**

Bedroom **Bed**

Bathroom **Bath**

SAANE



K

Page 192

LAMONE



K

Page 193

ATTIS



K

Page 193

CIRON



K

Page 193

LIBRA



K

Bed

Pages 194, 271

AVELINE



K

Page 195

ELVO



K

Page 195

ANGLE



K

Bed

Bath

Pages 196, 272, 329

M4 HANDLE SCREWS



Page 353



ALLEGRA



K

Page 197

AZALEA



K

Page 197

OXFORD



K

Bath

Pages 197, 328

CARE & MAINTENANCE



Page 352

Häfele recommended applications - Kitchen

K

Bedroom

Bed

Bathroom

Bath



NOMA



K Bath

Pages 199, 331



NICK



K Bath

Pages 198, 330



PATIENCE



K Bath

Pages 200, 332

RITTA



K Bath

Pages 201, 333



Häfele recommended applications - Kitchen **K**

Bedroom **Bed**

Bathroom **Bath**



CUTT



K

Page 202

RAIL



K

Page 203

INSTALLATION TOOLS



Pages 350-351

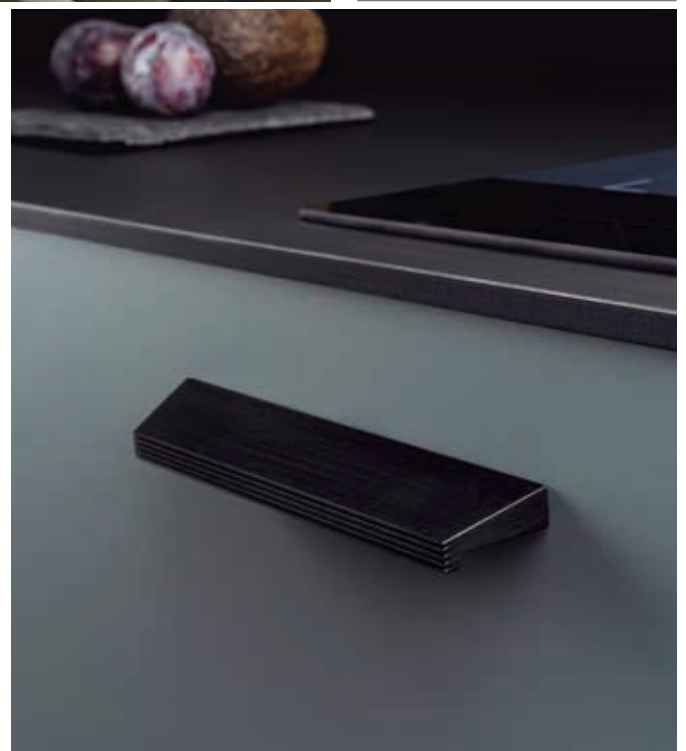

RUBY

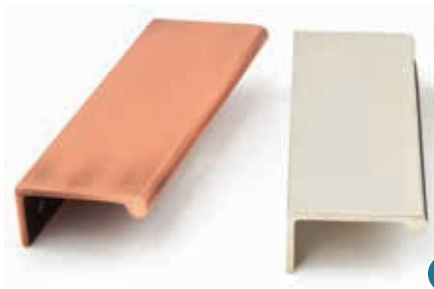

K

Bed

Bath

Pages 203, 270, 332

M4 HANDLE SCREWS



Page 353

CARE & MAINTENANCE



Page 352

Häfele recommended applications - Kitchen

K

Bedroom

Bed

Bathroom

Bath

SAUL



Page 204

MAGNUS



Page 204

AARON



Page 205

EPTE



Page 205



INDRE



Page 205

MONTONE



Page 206

HALKIN



Page 206

VIENNE



Page 207

AVEBURY



Page 207

CAVU



Page 207

ROYA



Page 208

AROS



Page 208

BESBRE



Page 208

M4 HANDLE SCREWS



Page 353

Häfele recommended applications - Kitchen

Bedroom

Bathroom



RHIN



K Bed

Pages 209, 274

AUTHIE



K

Page 209

CAVENDISH



K Bed

Pages 210, 274

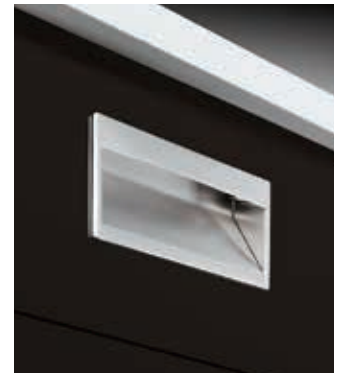

BLAVET



K

Page 210

MAINE



K Bed

Pages 210, 274



CUBIC



K Bed

Pages 275

SINTESI



K

Page 212



HIDE



K

Page 212

KATO



K

Page 212

PELLIPAR



K

Page 213

CARE & MAINTENANCE



Page 352



Häfele recommended applications - Kitchen

K

Bedroom

Bed

Bathroom

Bath

# GOLA PROFILES AND MATCHING PLINTHS FOR HANDLE FREE APPLICATIONS

Our on-trend range of complementary Gola profiles and plinths offers maximum style and functionality. There are six different systems in a choice of seven finishes available to suit a variety of different applications. Whether it's a matching finish or contrasting design, the Gola range guarantees an eye-catching kitchen experience.

AT A GLANCE

KITCHEN APPLICATIONS

BEDROOM APPLICATIONS

BATHROOM APPLICATIONS

HANDLE FREE APPLICATIONS

INSTALLATION & DISPLAY

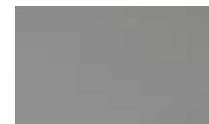

Silver anodised

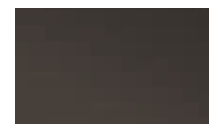

Bronze anodised



Graphite powder coated



Brushed brass anodised



Brushed copper anodised

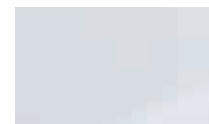

Matt white powder coated

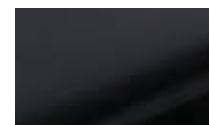

Matt black powder coated



Gola profiles and matching plinths are shown on pages **334-349**



SILVER ANODISED



BRUSHED COPPER ANODISED



BRUSHED BRASS ANODISED



GRAPHITE POWDER COATED

# ASPEKT CABINET DOORS FROM HÄFELE

The Aspekt range of cabinet doors encompasses the best-selling styles on the market today, at a range of price points to suit all budgets, all available for FREE delivery in 48-hours and with the backing of a Lifetime Guarantee and all the support you expect from Häfele.

AT A GLANCE

KITCHEN APPLICATIONS

BEDROOM APPLICATIONS

BATHROOM APPLICATIONS

HANDLE FREE APPLICATIONS

INSTALLATION & DISPLAY



SKYE - SLAB



YORK - SHAKER



STIRLING - J-PULL



HAMPSTEAD - ACRYLIC SLAB



View the full Aspekt cabinet doors range, visit [www.hafele.co.uk/aspekt-doors](http://www.hafele.co.uk/aspekt-doors)

FURNITURE HANDLES 2021, © Häfele U.K. Ltd 2021. Dimensional data not binding. We reserve the right to alter specifications without notice.

## Barkston, Barrington & Barnabus

AT A GLANCE

KITCHEN APPLICATIONS

BEDROOM APPLICATIONS

BATHROOM APPLICATIONS

HANDLE FREE APPLICATIONS

INSTALLATION & DISPLAY



Aspekt cabinet doors from Häfele - Skye gloss dove grey featured with stainless steel bar handles

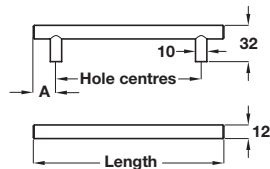

### BARKSTON bar handle, Ø 12 mm

- > \*2 each of M4 x 45 mm snap off handle screws included (101.20.700 includes an additional 1x M4 x 25 mm screw)
- > Order M4 handle screws separately
- > Steel
- > Order qty: 1 pc



Finish	Length	Hole centres	Dim. A	Cat. No.
 Stainless steel effect	136 mm	96 mm	20 mm	<b>101.20.709</b>
	168 mm	128 mm	20 mm	<b>101.20.700*</b>
	226 mm	156 mm	35 mm	<b>101.20.701*</b>
	230 mm	160 mm	35 mm	<b>101.20.710*</b>
	232 mm	192 mm	20 mm	<b>101.20.708</b>
	326 mm	256 mm	35 mm	<b>101.20.702*</b>
	376 mm	306 mm	35 mm	<b>101.20.703*</b>
	426 mm	356 mm	35 mm	<b>101.20.704</b>
	526 mm	456 mm	35 mm	<b>101.20.705</b>
	702 mm	632 mm	35 mm	<b>101.20.706</b>
	828 mm	758 mm	35 mm	<b>101.20.707*</b>

➕ View the full Aspekt cabinet doors range, visit [www.hafele.co.uk/aspekt-doors](http://www.hafele.co.uk/aspekt-doors)

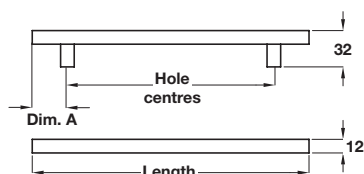

## BARRINGTON bar handle, Ø 12 mm

- > Order M4 handle screws separately
- > Steel handle, stainless steel effect
- > Order qty: 1 pc



Finish	Length	Hole centres	Dim. A	Cat. No.
Stainless steel effect	156 mm	96 mm	30 mm	<b>103.46.601</b>
	188 mm	128 mm	30 mm	<b>103.46.602</b>
	219 mm	160 mm	30 mm	<b>103.46.603</b>
	244 mm	184 mm	30 mm	<b>103.46.604</b>
	294 mm	234 mm	30 mm	<b>103.46.605</b>
	344 mm	284 mm	30 mm	<b>103.46.606</b>
	394 mm	334 mm	30 mm	<b>103.46.607</b>
	444 mm	284 mm	30 mm	<b>103.46.608</b>
	494 mm	434 mm	30 mm	<b>103.46.609</b>
	510 mm	450 mm	30 mm	<b>103.46.610</b>
	544 mm	484 mm	30 mm	<b>103.46.611</b>
	579 mm	519 mm	30 mm	<b>103.46.612</b>
	655 mm	595 mm	30 mm	<b>103.46.613</b>
	706 mm	646 mm	30 mm	<b>103.46.614</b>
	835 mm	775 mm	30 mm	<b>103.46.615</b>
844 mm	784 mm	30 mm	<b>103.46.616</b>	
920 mm	860 mm	30 mm	<b>103.46.617</b>	
<b>Additional centre support</b>				
	967 mm	907 mm	30 mm	<b>103.47.601</b>

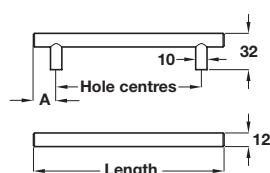

## BARNABUS bar handle, Ø 12 mm

- > 2 each of M4 x 45 mm snap off handle screws included (117.67.642\* includes an additional 1x M4 x 45 mm screw)
- > Steel
- > Order qty: 1 pc



Finish	Length	Hole centres	Dim. A	Cat. No.
Stainless steel effect	188 mm	128 mm	30 mm	<b>103.46.601</b>
	237 mm	177 mm	30 mm	<b>103.46.602</b>
	337 mm	277 mm	30 mm	<b>103.46.603</b>
	387 mm	327 mm	30 mm	<b>103.46.604</b>
	437 mm	377 mm	30 mm	<b>103.46.605</b>
	510 mm	450 mm	30 mm	<b>103.46.606</b>
	537 mm	477 mm	30 mm	<b>103.46.607</b>
	655 mm	595 mm	30 mm	<b>103.46.608</b>
	835 mm	775 mm	30 mm	<b>103.46.609</b>
	<b>Additional centre support</b>			
	1185 mm	560 mm	32.5 mm	<b>103.47.601</b>

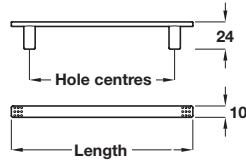

### MELINA pull handle

- > Order M4 handle screws separately
- > Zinc alloy
- > Order qty: 1 pc



Finish	Length	Hole centres	Cat. No.
Polished chrome	161.5 mm	128 mm	<b>111.38.222</b>
	193.5 mm	160 mm	<b>111.38.223</b>
	257.5 mm	224 mm	<b>111.38.225</b>

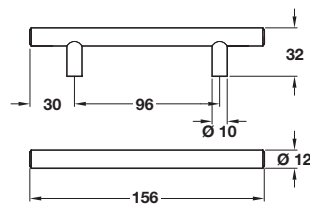

### ALICE bar handle, Ø 12 mm

- > 2x M4 x 45 mm snap off handle screws included
- > Steel
- > Order qty: 1 pc



Finish	Cat. No.
Polished chrome	<b>117.97.250</b>



Not for use on load bearing doors such as appliances

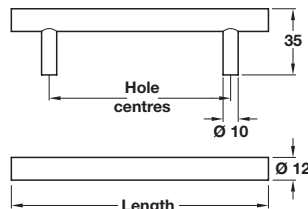

### BELLA bar handle, Ø 12 mm

- > Order M4 handle screws separately
- > Steel
- > Order qty: 1 pc



Finish	Length	Hole centres	Cat. No.
Polished chrome	136 mm	96 mm	<b>117.97.224</b>
	168 mm	128 mm	<b>117.97.225</b>
	200 mm	160 mm	<b>117.97.218</b>
	232 mm	192 mm	<b>117.97.227</b>
	328 mm	288 mm	<b>117.97.219</b>
	392 mm	352 mm	<b>117.97.229</b>



Don't forget to order M4 handle screws, see page **353**  
For our full range of fixing materials and installation tools see the Installation & Display section, pages **350-353**

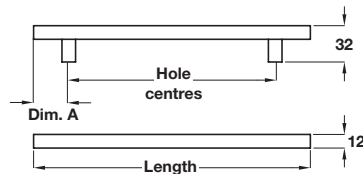

### BESWICK bar handle, Ø 12 mm

- > Order M4 handle screws separately
- > Please note: maximum bolt length = 28 mm + board thickness
- > Steel handle with brass feet
- > Order qty: 1 pc



Finish	Length	Hole centres	Dim. A	Cat. No.
Polished chrome-plated	156 mm	96 mm	30 mm	<b>117.52.201</b>
	188 mm	128 mm	30 mm	<b>117.52.202</b>
	244 mm	184 mm	30 mm	<b>117.52.204</b>

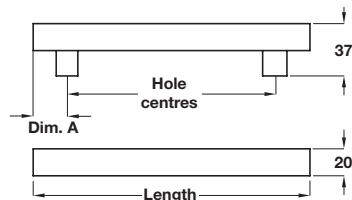

### INDIA bar handle, Ø 20 mm

- > Order M4 handle screws separately
- > Stainless steel
- > Order qty: 1 pc



Finish	Length	Hole centres	Dim. A	Cat. No.
Stainless steel effect	188 mm	128 mm	30 mm	<b>107.64.002</b>
	220 mm	160 mm	30 mm	<b>107.64.003</b>
	344 mm	284 mm	30 mm	<b>107.64.006</b>
	544 mm	484 mm	30 mm	<b>107.64.011</b>
	655 mm	595 mm	30 mm	<b>107.64.013</b>
	<b>With additional centre support</b>			
	835 mm	775 mm	30 mm	<b>107.64.015</b>

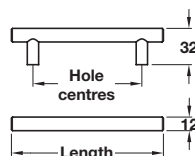

### BARTRAM bar handle

- > \*2x M4 x 20 mm, 2x M4 x 22 mm and 2x M4 x 25 mm screws included
- > Steel
- > Order qty: 1 pc



Finish	Length	Hole centres	Cat. No.
Antique copper	178 mm	128 mm	<b>117.97.062</b>
	220 mm	160 mm	<b>117.97.063*</b>
Brushed oil rubbed bronze	178 mm	128 mm	<b>117.97.162</b>
	220 mm	160 mm	<b>117.97.163</b>

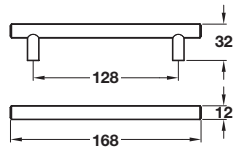

**PUMA bar handle**

- > Order M4 handle screws separately
- > Steel
- > Order qty: 1 pc



Finish	Cat. No.
 Matt black epoxy	<b>101.20.325</b>

**Pimlico**

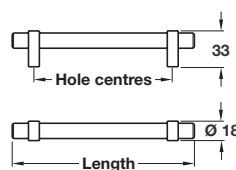

**PIMLICO bar handle**

- > Order M4 handle screws separately
- > Steel bar with zinc alloy feet
- > Order qty: 1 pc



Finish	Length	Hole centres	Cat. No.
 Stainless steel effect	168 mm	128 mm	<b>115.66.045</b>
	232 mm	192 mm	<b>115.66.045</b>
	264 mm	224 mm	<b>115.66.047</b>
	424 mm	384 mm	<b>115.66.048</b>



# Tiberius



Aspekt cabinet doors from Häfele - York matt slate grey featured with Tiberius bar handles in polished chrome finish

➕ View the full Aspekt cabinet doors range, visit [www.hafele.co.uk/aspekt-doors](http://www.hafele.co.uk/aspekt-doors)

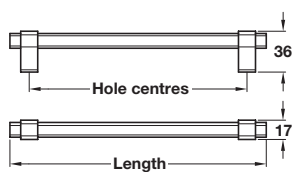

## TIBERIUS bar handle

- > 2x M4 x 25 mm handle screws included
- > Aluminium
- > Order qty: 1 pc



Finish	Length	Hole centres	Cat. No.
Polished chrome	163 mm	128 mm	<b>112.85.050</b>
	227 mm	192 mm	<b>112.85.051</b>
Black nickel	195 mm	160 mm	<b>112.85.071</b>

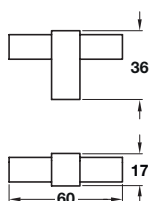

## TIBERIUS T knob

- > 1x M4 x 25 mm handle screw included
- > Aluminium
- > Order qty: 1 pc



Finish	Cat. No.
Black nickel	<b>112.85.095</b>

## Carrione

AT A GLANCE

KITCHEN APPLICATIONS

BEDROOM APPLICATIONS

BATHROOM APPLICATIONS

HANDLE FREE APPLICATIONS

INSTALLATION & DISPLAY

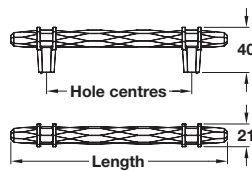

\*Product is subject to variations in finish due to the finishing and manufacturing process of certain materials

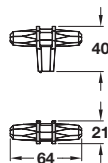

\*Product is subject to variations in finish due to the finishing and manufacturing process of certain materials

### CARRIONE pull handle

- > 2x 8/32 x 1" (non-metric) screws included
- > Zinc alloy
- > Order qty: 1 pc



Finish	Length	Hole centres	Cat. No.
Marble white / Polished nickel	160 mm	96 mm	<b>133.53.035</b>
	191 mm	128 mm	<b>133.53.036</b>
Marble white / Oil rubbed bronze*	160 mm	96 mm	<b>133.53.037</b>
	191 mm	128 mm	<b>133.53.038</b>



### CARRIONE T knob

- > 1x 8/32 x 1" (non-metric) screw included
- > Zinc alloy
- > Order qty: 1 pc



Finish	Cat. No.
Marble white / Polished nickel	<b>133.53.033</b>
Marble white / Oil rubbed bronze*	<b>133.53.034</b>



All handles on this page include 8/32 x 1" (non-metric) screws. If you require a different length order non-metric cut off screw Cat. No. 022.24.881 shown on page **353**

# St. Vincent



AT A GLANCE

KITCHEN APPLICATIONS

BEDROOM APPLICATIONS

BATHROOM APPLICATIONS

HANDLE FREE APPLICATIONS

INSTALLATION & DISPLAY





## ST. VINCENT pull handle

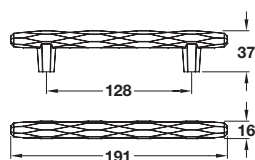

- > 2x 8/32 x 1" (non-metric) screws included
- > Zinc alloy
- > Order qty: 1 pc



Finish	Cat. No.
 Polished nickel	133.50.388
 Golden champagne	133.50.382





## ST. VINCENT T knob

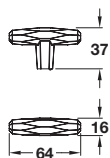

- > 1x 8/32 x 1" (non-metric) screw included
- > Zinc alloy
- > Order qty: 1 pc



Finish	Cat. No.
 Polished nickel	133.50.641
 Golden champagne	133.50.639



Don't forget to order M4 handle screws, see page **353**  
 For our full range of fixing materials and installation tools see the Installation & Display section, pages **350-353**

## Tilaa

AT A GLANCE

KITCHEN APPLICATIONS

BEDROOM APPLICATIONS

BATHROOM APPLICATIONS

HANDLE FREE APPLICATIONS

INSTALLATION & DISPLAY

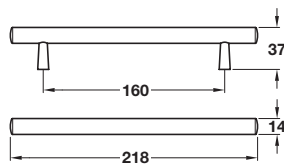



Product is subject to variations in colour and dimensions due to being manufactured from natural materials

### TILAA bar handle

- > 2x M4 x 30 mm handle screws included
- > \*Order M4 handles screws separately
- > Oak or walnut and copper
- > Order qty: 1 pc



Finish	Cat. No.
 Smoked oak / Copper	<b>193.18.426</b>
 Walnut / Copper	<b>193.18.736*</b>



**VENUS pull handle**

- > Order M4 handle screws separately
- > Oak, lacquered
- > Order qty: 1 pc

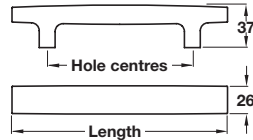

Finish	Length	Hole centres	Cat. No.
Lacquered oak	190 mm	128 mm	<b>193.18.430</b>
	316 mm	224 mm	<b>193.18.431</b>

Product is subject to variations in colour and dimensions due to being manufactured from natural materials

## BESPOKE TIMBER DRAWERS

Kitchen drawers are becoming an increasingly popular alternative to traditional cabinets. Our drawer range includes many different sizes and finishes, including a handcrafted, bespoke-sized timber option.



Walnut



Ply

Our Bespoke Timber Drawers are handmade in the UK from high grade solid timber. There are a number of design and personalisation choices available including a choice of wood types and come complete with dove-tailed joints.

The Häfele to Order service takes the manufacture, finishing, packaging and delivery off your hands, saving you time and money.



Find out more at [www.hafele.co.uk/bespoke-timber-drawers](http://www.hafele.co.uk/bespoke-timber-drawers)



Oak

FURNITURE HANDLES 2021, © Häfele U.K. Ltd 2021. Dimensional data not binding. We reserve the right to alter specifications without notice.

➡ Don't forget to order M4 handle screws, see page **353**  
 For our full range of fixing materials and installation tools see the Installation & Display section, pages **350-353**

# ASPEKT KITCHEN CABINET DOORS FROM HÄFELE



Hampstead Ultragloss Aqua Blue

Introducing our NEW collection of kitchen cabinet doors. Manufactured in the UK and with the FIRA Gold quality seal of approval, these doors come with a Häfele lifetime guarantee\*.

Our range of door sizes make an easy job of designing kitchens, including built-in appliances. Visit [www.hafele.co.uk/aspekt-doors](http://www.hafele.co.uk/aspekt-doors) to see the full range.

Key features include:

- > 18 colours and finishes
- > FIRA Gold approved
- > Free 48 hour delivery\*
- > No minimum order quantity

\*Ts & Cs apply



Skye Matt Midnight Blue



York Matt Slate Grey



Stirling Gloss Dove Grey

Visit [hafele.co.uk/aspekt-doors](http://hafele.co.uk/aspekt-doors) to view the full range

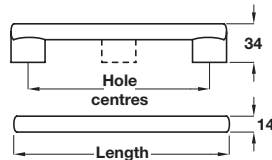

### BAYSWATER bar handle

- > Order M4 handle screws separately
- > Brushed stainless steel bar with stainless steel effect zinc alloy feet
- > Order qty: 1 pc



Finish	Length	Hole centres	Cat. No.
Brushed stainless steel / Stainless steel effect	190 mm	160 mm	<b>108.64.002</b>
	222 mm	192 mm	<b>108.64.003</b>
	254 mm	224 mm	<b>108.64.000</b>
	318 mm	288 mm	<b>108.64.005</b>
	478 mm	448 mm	<b>108.64.008</b>

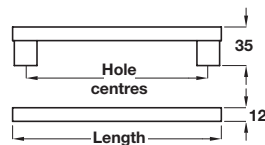

### ORLANA bar handle

- > Order M4 handle screws separately
- > Zinc alloy feet in a satin brushed finish, with brushed satin stainless steel bar
- > Order qty: 1 pc



Finish	Length	Hole centres	Cat. No.
Satin brushed / Brushed satin stainless steel	150 mm	128 mm	<b>155.01.470</b>
	182 mm	160 mm	<b>155.01.471</b>
	214 mm	192 mm	<b>155.01.472</b>
	310 mm	288 mm	<b>155.01.473</b>
	342 mm	320 mm	<b>155.01.474</b>
	514 mm	492 mm	<b>155.01.475</b>
	814 mm	792 mm	<b>155.01.476</b>

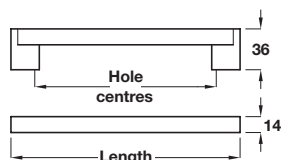

### BOROS boss bar handle

- > Order M4 handle screws separately
- > Steel bar with zinc alloy feet
- > Order qty: 1 pc



Finish	Length	Hole centres	Cat. No.
Stainless steel effect	170 mm	128 mm	<b>108.63.001</b>
	202 mm	160 mm	<b>108.63.002</b>
	234 mm	192 mm	<b>108.63.003</b>
	298 mm	256 mm	<b>108.63.004</b>
	362 mm	320 mm	<b>108.63.006</b>
	490 mm	448 mm	<b>108.63.008</b>



Don't forget to order M4 handle screws, see page **353**

For our full range of fixing materials and installation tools see the Installation & Display section, pages **350-353**

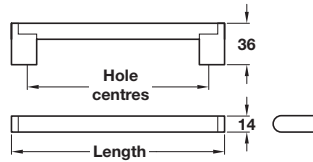

### BOSTON boss bar handle

- > Order M4 handle screws separately
- > \*2x M4 x 25 mm, 2x M4 x 25 mm and 2x M4 x 28 mm screws included
- > Zinc alloy ends, with hollow stainless steel tube or solid steel bar
- > Order qty: 1 pc



Finish	Length	Hole centres	Cat. No.
Stainless steel effect	<b>Hollow stainless steel tube</b>		
	156 mm	128 mm	<b>115.69.002</b>
	188 mm	160 mm	<b>115.69.003*</b>
	220 mm	192 mm	<b>115.69.004</b>
	237 mm	209 mm	<b>104.74.011</b>
	284 mm	256 mm	<b>115.69.006</b>
	337 mm	309 mm	<b>104.74.012</b>
	348 mm	320 mm	<b>115.69.008</b>
	387 mm	359 mm	<b>104.74.013</b>
	437 mm	409 mm	<b>104.74.014</b>
	476 mm	448 mm	<b>115.69.009</b>
	537 mm	509 mm	<b>104.74.015</b>
	<b>Solid steel bar</b>		
	751 mm	709 mm	<b>104.74.016</b>
849 mm	807 mm	<b>104.74.017</b>	
951 mm	909 mm	<b>104.74.018</b>	
1199 mm	1157 mm	<b>104.74.019</b>	

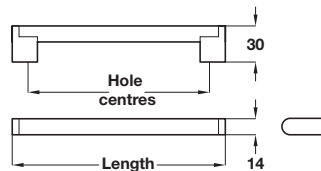

### BEULAH boss bar handle

- > Order M4 handle screws separately
- > \*2x M4 x 45 mm snap off screws included
- > Zinc alloy ends in a stainless steel finish, with hollow stainless steel tube
- > Order qty: 1 pc



Finish	Length	Hole centres	Cat. No.
Polished chrome	156 mm	128 mm	<b>104.74.030*</b>
	188 mm	160 mm	<b>104.74.031</b>
	237 mm	209 mm	<b>104.74.032</b>
	316 mm	288 mm	<b>104.74.033*</b>
	337 mm	309 mm	<b>104.74.034</b>
	387 mm	359 mm	<b>104.74.035</b>
	437 mm	409 mm	<b>104.74.036</b>
	476 mm	448 mm	<b>104.74.037</b>
	537 mm	509 mm	<b>104.74.038</b>
	636 mm	608 mm	<b>104.74.039</b>
	751 mm	709 mm	<b>104.74.040</b>
	849 mm	807 mm	<b>104.74.041</b>
937 mm	909 mm	<b>104.74.042</b>	



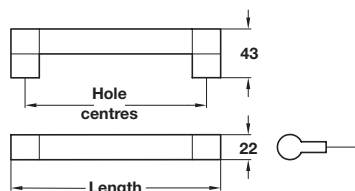

### CHELSEA keyhole bar handle, Ø 22 mm

- > Order M4 handle screws separately
- > Zinc alloy ends with stainless steel tube, in a stainless steel effect finish
- > Order qty: 1 pc



Finish	Length	Hole centres	Cat. No.
Polished chrome	153 mm	128 mm	<b>115.69.012</b>
	185 mm	160 mm	<b>115.69.013</b>
	281 mm	256 mm	<b>115.69.016</b>
	381 mm	356 mm	<b>115.69.017</b>
	537 mm	512 mm	<b>115.69.018</b>
	657 mm	632 mm	<b>115.69.019</b>

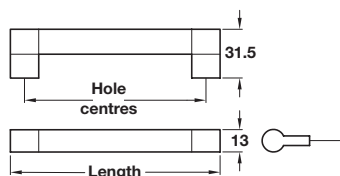

### GIGI keyhole bar handle

- > Order M4 handle screws separately
- > Zinc alloy ends in a stainless steel finish, with stainless steel tube
- > Order qty: 1 pc



Finish	Length	Hole centres	Cat. No.
Stainless steel	205 mm	192 mm	<b>115.69.027</b>

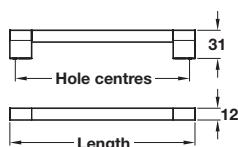

### LYDIATE keyhole bar handle, Ø 12 mm

- > Order M4 handle screws separately
- > Brushed stainless steel bar with polished chrome zinc alloy ends
- > Order qty: 1 pc



Finish	Length	Hole centres	Cat. No.
Brushed st. steel	173 mm	160 mm	<b>115.69.056</b>
	204 mm	192 mm	<b>101.24.007</b>



Don't forget to order M4 handle screws, see page **353**

For our full range of fixing materials and installation tools see the Installation & Display section, pages **350-353**

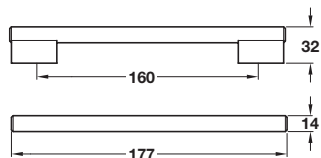
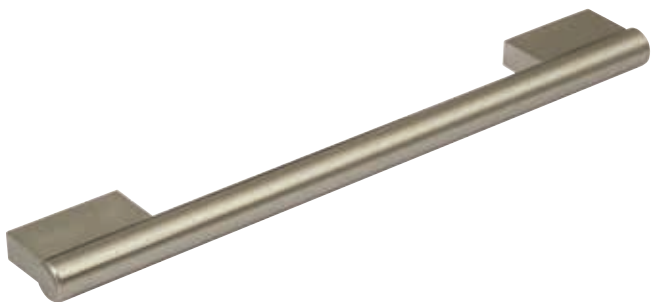

### LAUREL bar handle

- > Order M4 handle screws separately
- > Zinc alloy feet and stainless steel bar
- > Order qty: 1 pc



Finish	Cat. No.
Stainless steel effect	107.46.665

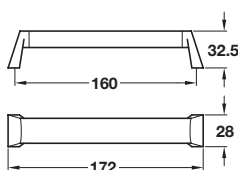

### NUGENT angled boss bar handle

- > Order M4 handle screws separately
- > Zinc alloy feet and stainless steel bar
- > Order qty: 1 pc



Finish	Cat. No.
Stainless steel effect	104.74.006

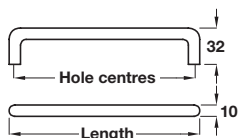

### MANDALAY D handle

- > Order M4 handle screws separately
- > \*2x M4 x 25 mm handle screws included
- > Grade 304 stainless steel
- > Order qty: 1 pc



Finish	Length	Hole centres	Cat. No.
Brushed stainless steel	74 mm	64 mm	117.40.613
	106 mm	96 mm	117.40.622
	138 mm	128 mm	117.40.631*
	170 mm	160 mm	117.40.640
	298 mm	288 mm	117.40.659
	362 mm	352 mm	117.40.668

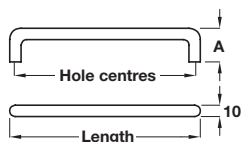

### D handle, Ø 10 mm

- > Order M4 handle screws separately
- > Steel
- > Order qty: 1 pc



Finish	Length	Hole centres	Dim. A	Cat. No.
Matt chrome	106 mm	96 mm	28 mm	<b>116.09.015</b>
	138 mm	128 mm	28 mm	<b>116.09.085</b>
Matt nickel	106 mm	96 mm	28 mm	<b>116.09.615</b>
	138 mm	128 mm	28 mm	<b>116.09.685</b>

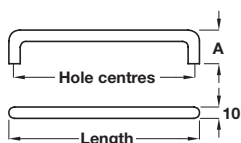

### D handle, Ø 10 mm

- > Order M4 handle screws separately
- > Steel
- > Order qty: 1 pc



Finish	Length	Hole centres	Dim. A	Cat. No.
Polished chrome	106 mm	96 mm	28 mm	<b>116.09.214</b>
	106 mm	96 mm	32 mm	<b>109.66.201</b>
	138 mm	128 mm	28 mm	<b>116.09.285</b>
Matt black	106 mm	96 mm	28 mm	<b>106.45.301</b>
	138 mm	128 mm	28 mm	<b>106.45.302</b>

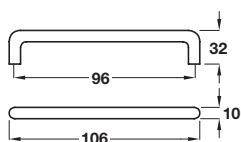

### D handle, Ø 10 mm

- > Order M4 handle screws separately
- > Anodised aluminium
- > Order qty: 1 pc



Finish	Cat. No.
Silver coloured	<b>116.05.941</b>





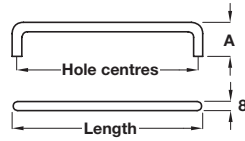

Don't forget to order M4 handle screws, see page **353**  
For our full range of fixing materials and installation tools see the Installation & Display section, pages **350-353**



### D handle, Ø 8 mm

- > Order M4 handle screws separately
- > Steel
- > Order qty: 1 pc



Finish	Length	Hole centres	Dim. A	Cat. No.
 Polished chrome	104 mm	96 mm	30 mm	<b>116.07.225</b>
	136 mm	128 mm	30 mm	<b>116.07.244</b>
	168 mm	160 mm	30 mm	<b>106.44.204</b>
	264 mm	256 mm	28 mm	<b>106.44.207</b>
 Aluminium coloured	104 mm	96 mm	30 mm	<b>106.44.402</b>
	136 mm	128 mm	30 mm	<b>106.44.403</b>
	168 mm	160 mm	30 mm	<b>106.44.404</b>
	200 mm	192 mm	28 mm	<b>106.44.405</b>
	264 mm	256 mm	28 mm	<b>106.44.407</b>
	328 mm	320 mm	28 mm	<b>106.44.409</b>
	456 mm	448 mm	30 mm	<b>106.44.413</b>
 Black	136 mm	128 mm	28 mm	<b>106.44.303</b>
 White	104 mm	96 mm	28 mm	<b>106.44.702</b>
	136 mm	128 mm	28 mm	<b>106.44.703</b>

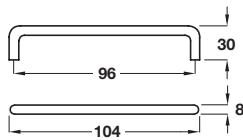

### D handle, Ø 8 mm

- > Order M4 handle screws separately
- > Steel
- > Order qty: 1 pc



Finish	Cat. No.
 Matt nickel-plated	<b>155.00.914</b>



Don't forget to order M4 handle screws, see page **353**  
 For our full range of fixing materials and installation tools see the Installation & Display section, pages **350-353**

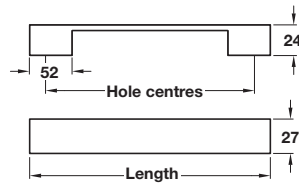

### MUSGRAVE D handle

- > Order M4 handle screws separately
- > Aluminium
- > Order qty: 1 pc



Finish	Length	Hole centres	Cat. No.
Stainless steel effect	217 mm	192 mm	<b>112.90.014</b>
	281 mm	256 mm	<b>112.90.006</b>

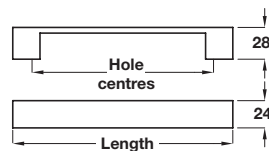

### CONWAY D handle

- > Order M4 handle screws separately
- > Aluminium
- > Order qty: 1 pc



Finish	Length	Hole centres	Cat. No.
Polished chrome	194 mm	160 mm	<b>111.34.253</b>
	226 mm	192 mm	<b>111.34.264</b>
Stainless steel effect	194 mm	160 mm	<b>111.34.053</b>
	226 mm	192 mm	<b>111.34.064</b>

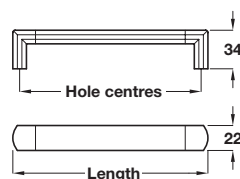

### ARGYLL D handle

- > Order M4 handle screws separately
- > Zinc alloy feet with aluminium bar
- > Order qty: 1 pc



Finish	Length	Hole centres	Cat. No.
Stainless steel effect	140 mm	128 mm	<b>113.50.602</b>
	172 mm	160 mm	<b>113.50.603</b>
	236 mm	224 mm	<b>113.50.605</b>
	332 mm	320 mm	<b>113.50.608</b>

## Lama

AT A GLANCE

KITCHEN APPLICATIONS

BEDROOM APPLICATIONS

BATHROOM APPLICATIONS

HANDLE FREE APPLICATIONS

INSTALLATION & DISPLAY



Front view showing handle is curved along the bottom edge

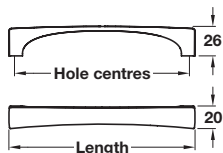

### LAMA pull handle

- > 2x M4 x 30 mm handles screws included
- > Zinc alloy
- > Order qty: 1 pc



Finish	Length	Hole centres	Cat. No.
Polished chrome	170 mm	160 mm	<b>110.22.296</b>
	330 mm	320 mm	<b>110.22.299</b>
Graphite	170 mm	160 mm	<b>110.22.596</b>
	330 mm	320 mm	<b>110.22.599</b>

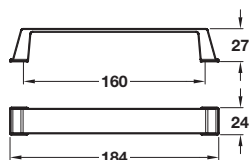

### DUKE pull handle

- > Order M4 handle screws separately
- > Zinc alloy
- > Order qty: 1 pc



Finish	Cat. No.
 Graphite	111.34.506

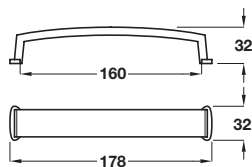

### LEOPOLD D handle

- > Order M4 handle screws separately
- > Aluminium
- > Order qty: 1 pc



Finish	Cat. No.
 Stainless steel effect	106.92.604



Don't forget to order M4 handle screws, see page **353**  
For our full range of fixing materials and installation tools see the Installation & Display section, pages **350-353**

## Pembridge

AT A GLANCE

KITCHEN APPLICATIONS

BEDROOM APPLICATIONS

BATHROOM APPLICATIONS

HANDLE FREE APPLICATIONS

INSTALLATION & DISPLAY

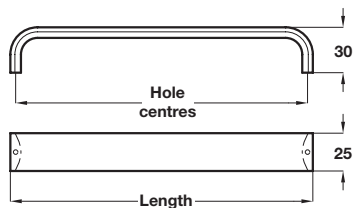

### PEMBRIDGE D handle

- > 2x M4 x 25 mm handle screws included
- > Aluminium
- > Order qty: 1 pc



Finish	Length	Hole centres	Cat. No.
Polished chrome	136 mm	128 mm	<b>116.04.225</b>
	200 mm	192 mm	<b>116.04.227</b>
	328 mm	320 mm	<b>116.04.228</b>
Stainless steel effect	136 mm	128 mm	<b>116.04.625</b>
	200 mm	192 mm	<b>116.04.627</b>
	328 mm	320 mm	<b>116.04.628</b>



# Lyle

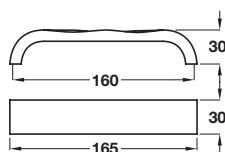

## LYLE pull handle

- > Order M4 handle screws separately
- > Zinc alloy
- > Order qty: 1 pc



Finish	Cat. No.
 Polished chrome	107.89.233

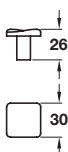

## LYLE knob

- > Order M4 handle screws separately
- > Zinc alloy
- > Order qty: 1 pc



Finish	Cat. No.
 Polished chrome	133.26.230



Don't forget to order M4 handle screws, see page **353**  
 For our full range of fixing materials and installation tools see the Installation & Display section, pages **350-353**



### FACTORY D handle

- > Order M4 handle screws separately
- > Zinc alloy
- > Order qty: 1 pc

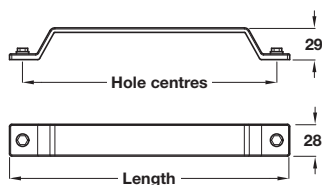

Product is subject to variations in finish due to the finishing and manufacturing process of certain materials

Finish	Length	Hole centres	Cat. No.
Iron effect matt	183 mm	160 mm	<b>116.60.200</b>
	247 mm	224 mm	<b>116.60.201</b>
Antique brass	183 mm	160 mm	<b>116.60.220</b>
	247 mm	224 mm	<b>116.60.221</b>



## BESPOKE TIMBER DRAWERS

Kitchen drawers are becoming an increasingly popular alternative to traditional cabinets. Our drawer range includes many different sizes and finishes, including a handcrafted, bespoke-sized timber option.



Walnut



Ply

Our Bespoke Timber Drawers are handmade in the UK from high grade solid timber. There are a number of design and personalisation choices available including a choice of wood types and come complete with dove-tailed joints.

The Häfele to Order service takes the manufacture, finishing, packaging and delivery off your hands, saving you time and money.



Oak

Find out more at [www.hafele.co.uk/bespoke-timber-drawers](http://www.hafele.co.uk/bespoke-timber-drawers)

# Button



AT A GLANCE

KITCHEN APPLICATIONS

BEDROOM APPLICATIONS

BATHROOM APPLICATIONS

HANDLE FREE APPLICATIONS



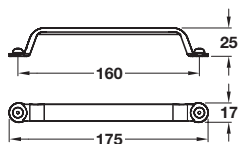

INSTALLATION & DISPLAY



## BUTTON D handle

- > 2x M4 x 25 mm handle screws included
- > Zinc alloy
- > Order qty: 1 pc



Finish	Cat. No.
 Pewter	106.69.691
 Antique bronze	106.69.692
 Polished chrome	106.69.693
 Matt black	106.69.694

## Osaka

AT A GLANCE

KITCHEN APPLICATIONS

BEDROOM APPLICATIONS

BATHROOM APPLICATIONS

HANDLE FREE APPLICATIONS

INSTALLATION & DISPLAY

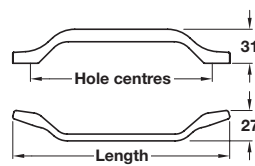

### OSAKA pull handle

- > Fixings included:
  - Satin brass - 2x M4 x 50 mm snap-off handle screws
  - Antique copper and graphite - 2 each of M4 x 22 mm and M4 x 26 mm handle screws
- > Zinc alloy
- > Order qty: 1 pc



Finish	Length	Hole centres	Cat. No.
Satin brass	127 mm	96 mm	<b>110.22.080</b>
	191 mm	160 mm	<b>110.22.081</b>
Antique copper	191 mm	160 mm	<b>110.22.086</b>
	351 mm	320 mm	<b>110.22.089</b>
Graphite	191 mm	160 mm	<b>110.22.586</b>

# Putney



AT A GLANCE

KITCHEN APPLICATIONS

BEDROOM APPLICATIONS

BATHROOM APPLICATIONS

HANDLE FREE APPLICATIONS

INSTALLATION & DISPLAY

FURNITURE HANDLES 2021, © Häfele U.K. Ltd 2021. Dimensional data not binding. We reserve the right to alter specifications without notice.

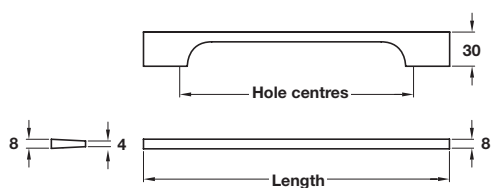

## PUTNEY pull handle

- > 2x M4 x 45 mm snap off screws included
- > Aluminium
- > Order qty: 1 pc



Finish	Length	Hole centres	Cat. No.
Polished chrome	256 mm	192 mm	<b>109.48.207</b>
	352 mm	288 mm	<b>109.48.209</b>
Stainless steel effect	256 mm	192 mm	<b>109.48.607</b>
	352 mm	288 mm	<b>109.48.609</b>

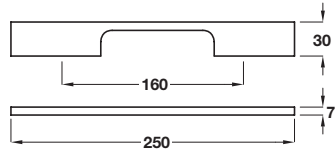
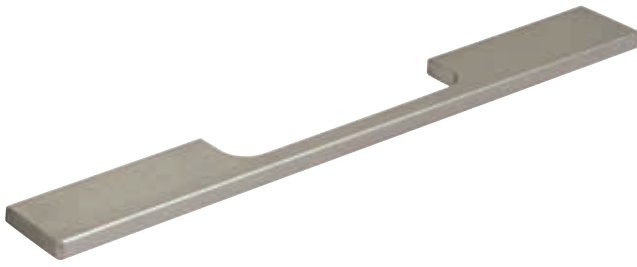

### ARVE pull handle

- > Order M4 handle screws separately
- > Aluminium
- > Order qty: 1 pc



Finish	Cat. No.
Polished chrome	<b>112.62.203</b>
Stainless steel effect	<b>112.62.003</b>

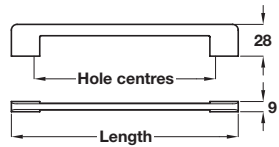

### MALVAN D handle

- > Order M4 handle screws separately
- > Zinc alloy
- > Order qty: 1 pc



Finish	Length	Hole centres	Cat. No.
Stainless steel effect	345 mm	320 mm	<b>110.28.038</b>

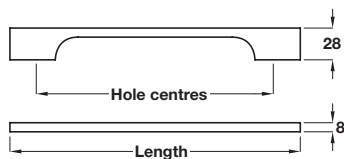

### BIKO pull handle

- > 2x M4 handle screws included
- > Aluminium
- > Order qty: 1 pc



Finish	Length	Hole centres	Cat. No.
Polished chrome	256 mm	192 mm	<b>111.64.234</b>
	352 mm	288 mm	<b>111.64.237</b>



Don't forget to order M4 handle screws, see page **353**  
For our full range of fixing materials and installation tools see the Installation & Display section, pages **350-353**

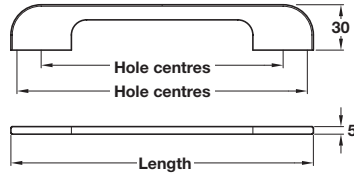

### BRONTE D handle

- > Order M4 handle screws separately
- > Zinc alloy
- > Order qty: 1 pc



Finish	Length	Hole centres	Cat. No.
Polished chrome	200 mm	160/192 mm	<b>113.96.246</b>
	330 mm	288/320 mm	<b>113.96.249</b>

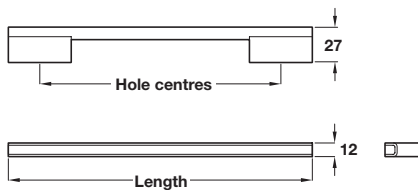

### ENZA bar handle

- > Order M4 handle screws separately
- > Aluminium, polished chrome body, with stainless steel effect insert
- > Order qty: 1 pc



Finish	Length	Hole centres	Cat. No.
Polished chrome / Stainless steel effect	268 mm	256 mm	<b>108.94.276</b>



### KESWICK square D handle

- > Order M4 handle screws separately
- > Zinc alloy feet with aluminium tube
- > Order qty: 1 pc



Finish	Cat. No.
Stainless steel effect	<b>102.12.056</b>

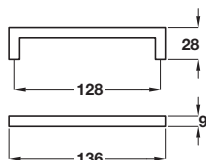
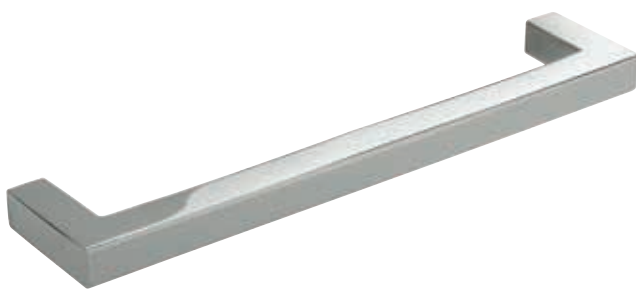

### MORGAN D handle

- > Order M4 handle screws separately
- > Zinc alloy
- > Order qty: 1 pc



Finish	Cat. No.
Polished chrome	102.12.232



## BESPOKE TIMBER DRAWERS

Kitchen drawers are becoming an increasingly popular alternative to traditional cabinets. Our drawer range includes many different sizes and finishes, including a handcrafted, bespoke-sized timber option.



Walnut



Ply

Our Bespoke Timber Drawers are handmade in the UK from high grade solid timber. There are a number of design and personalisation choices available including a choice of wood types and come complete with dove-tailed joints.

The Häfele to Order service takes the manufacture, finishing, packaging and delivery off your hands, saving you time and money.



Oak

Find out more at [www.hafele.co.uk/bespoke-timber-drawers](http://www.hafele.co.uk/bespoke-timber-drawers)



Don't forget to order M4 handle screws, see page **353**  
For our full range of fixing materials and installation tools see the Installation & Display section, pages **350-353**



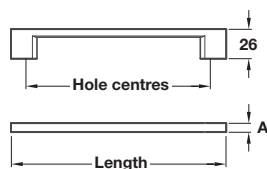

### LINCOLN D handle

- > Order M4 handle screws separately
- > Zinc alloy
- > Order qty: 1 pc



Finish	Length	Hole centres	Dim. A	Cat. No.
Polished chrome	113 mm	96 mm	7.5 mm	<b>107.03.244</b>
	189 mm	160 mm	7.5 mm	<b>107.24.246</b>
	224 mm	192 mm	9 mm	<b>107.24.247</b>
	290 mm	256 mm	9 mm	<b>107.24.248</b>
	353 mm	320 mm	9 mm	<b>107.24.249</b>
Stainless steel effect	113 mm	96 mm	7.5 mm	<b>107.03.644</b>
	189 mm	160 mm	7.5 mm	<b>107.24.646</b>
	224 mm	192 mm	9 mm	<b>107.24.647</b>
	290 mm	256 mm	9 mm	<b>107.24.648</b>
	353 mm	320 mm	9 mm	<b>107.24.649</b>

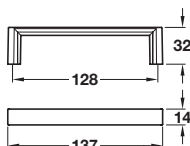

### JUTLAND pull handle

- > Order M4 handle screws separately
- > Zinc alloy
- > Order qty: 1 pc



Finish	Cat. No.
Polished chrome	<b>107.03.235</b>
Stainless steel effect	<b>107.03.635</b>

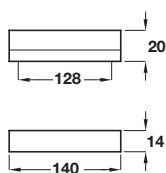

### LUELLA pull handle

- > Order M4 handle screws separately
- > Aluminium
- > Order qty: 1 pc



Finish	Cat. No.
Anodised	<b>109.49.935</b>



Don't forget to order M4 handle screws, see page **353**  
For our full range of fixing materials and installation tools see the Installation & Display section, pages **350-353**

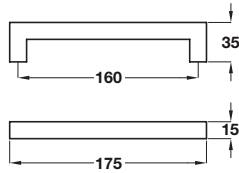

### LARISSA square D handle

- > Order M4 handle screws separately
- > Zinc alloy
- > Order qty: 1 pc



Finish	Cat. No.
Dark matt nickel (sand blast)	<b>102.12.606</b>

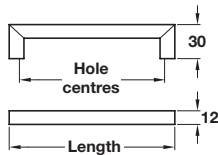

### BALTIMORE D handle

- > Order M4 handle screws separately
- > Zinc alloy
- > Order qty: 1 pc



Finish	Length	Hole centres	Cat. No.
Polished chrome	114 mm	96 mm	<b>102.12.201</b>
	146 mm	128 mm	<b>102.12.202</b>

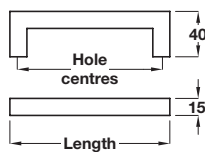

### HARGRAVE D handle

- > 2x M4 x 25 mm handle screws included
- > Brushed stainless steel
- > Order qty: 1 pc



Finish	Length	Hole centres	Cat. No.
Brushed stainless steel	141 mm	128 mm	<b>100.45.061</b>
	173 mm	160 mm	<b>100.45.062</b>
	205 mm	192 mm	<b>100.45.063</b>
	269 mm	256 mm	<b>100.45.065</b>
	333 mm	320 mm	<b>100.45.067</b>
	461 mm	448 mm	<b>115.41.011</b>

# ASPEKT KITCHEN CABINET DOORS FROM HÄFELE



Hampstead Ultragloss Aqua Blue

Introducing our NEW collection of kitchen cabinet doors. Manufactured in the UK and with the FIRA Gold quality seal of approval, these doors come with a Häfele lifetime guarantee\*.

Our range of door sizes make an easy job of designing kitchens, including built-in appliances. Visit [www.hafele.co.uk/aspekt-doors](http://www.hafele.co.uk/aspekt-doors) to see the full range.

Key features include:

- > 18 colours and finishes
- > FIRA Gold approved
- > Free 48 hour delivery\*
- > No minimum order quantity

\*Ts & Cs apply



Skye Matt Midnight Blue



York Matt Slate Grey



Stirling Gloss Dove Grey

Visit [hafele.co.uk/aspekt-doors](http://hafele.co.uk/aspekt-doors) to view the full range

## Metropolis

The Metropolis range includes pull handles, bar handles and knobs in satin stainless steel

AT A GLANCE

KITCHEN APPLICATIONS

BEDROOM APPLICATIONS

BATHROOM APPLICATIONS

HANDLE FREE APPLICATIONS

INSTALLATION & DISPLAY

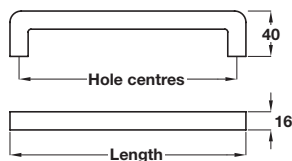

### METROPOLIS pull handle

- > 2x M4 x 25 mm handle screws included
- > Grade 304 stainless steel
- > Order qty: 1 pc



Finish	Length	Hole centres	Cat. No.
Satin stainless steel	208 mm	192 mm	<b>115.62.004</b>
	336 mm	320 mm	<b>115.62.008</b>
	464 mm	448 mm	<b>115.62.011</b>

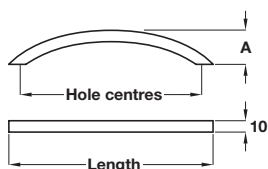

### METROPOLIS bow handle

- > 2x M4 x 25 mm handle screws included
- > Grade 304 stainless steel
- > Order qty: 1 pc



Finish	Length	Hole centres	Dim. A	Cat. No.
Satin stainless steel	181 mm	160 mm	31 mm	<b>100.55.003</b>
	259 mm	224 mm	32 mm	<b>100.55.005</b>
	365 mm	320 mm	33 mm	<b>100.55.008</b>

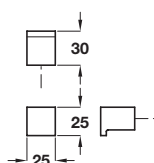

### METROPOLIS knob

- > 1x M4 x 25 mm handle screw included
- > Grade 303 stainless steel
- > Order qty: 1 pc



Finish	Size	Height	Cat. No.
Satin stainless steel	25 mm	30 mm	<b>132.94.010</b>



### METROPOLIS knob



- > 1x M4 x 25 mm handle screw included
- > Grade 303 stainless steel
- > Order qty: 1 pc

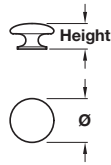

Finish	Diameter	Height	Cat. No.
Satin stainless steel	Ø 32 mm	30 mm	<b>134.28.010</b>
	Ø 38 mm	30 mm	<b>132.94.040</b>
	Ø 60 mm	35 mm	<b>134.28.011</b>



### METROPOLIS knob



- > 1x M4 x 25 mm handle screw included
- > Grade 303 stainless steel
- > Order qty: 1 pc

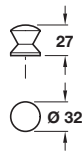

Finish	Diameter	Height	Cat. No.
Satin stainless steel	Ø 32 mm	27 mm	<b>134.28.020</b>



Knob



Backplate

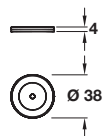
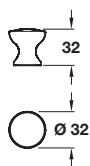

### METROPOLIS knob and backplate



- > 1x M4 x 25 mm handle screw included
- > Grade 303 stainless steel
- > Order qty: 1 pc



Finish	Item	Cat. No.
Satin stainless steel	Knob	<b>132.94.030</b>
	Backplate	<b>132.94.090</b>

**+** Use with or without backplate. Order backplate separately

Plane

AT A GLANCE

KITCHEN APPLICATIONS

BEDROOM APPLICATIONS

BATHROOM APPLICATIONS

HANDLE FREE APPLICATIONS

INSTALLATION & DISPLAY

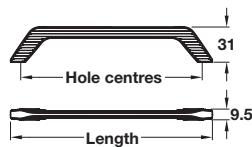

**PLANE pull handle**

- > Order M4 handle screws separately
- > Zinc alloy
- > Order qty: 1 pc



Finish	Length	Hole centres	Cat. No.
Matt anthracite	178 mm	160 mm	<b>111.71.516</b>
	338 mm	320 mm	<b>111.71.517</b>

➔ Don't forget to order M4 handle screws, see page **353**  
 For our full range of fixing materials and installation tools see the Installation & Display section, pages **350-353**

# Level



AT A GLANCE

KITCHEN APPLICATIONS

BEDROOM APPLICATIONS

BATHROOM APPLICATIONS

HANDLE FREE APPLICATIONS

INSTALLATION & DISPLAY

FURNITURE HANDLES 2021, © Häfele U.K. Ltd 2021. Dimensional data not binding. We reserve the right to alter specifications without notice.

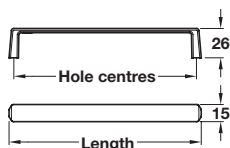

### LEVEL pull handle

- > Order M4 handle screws separately
- > Zinc alloy
- > Order qty: 1 pc



Finish	Length	Hole centres	Cat. No.
 Matt anthracite	72 mm	64 mm	<b>111.71.505</b>
	168 mm	160 mm	<b>111.71.506</b>
	328 mm	320 mm	<b>111.71.507</b>

## Oasi

AT A GLANCE

KITCHEN APPLICATIONS

BEDROOM APPLICATIONS

BATHROOM APPLICATIONS

HANDLE FREE APPLICATIONS

INSTALLATION & DISPLAY

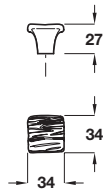
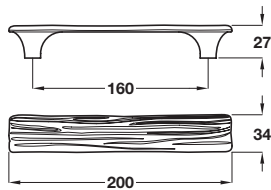

### OASI bar handle

- > Order M4 handle screws separately
- > Zinc alloy
- > Order qty: 1 pc



Finish	Cat. No.
 Polished chrome	116.60.213

### OASI knob

- > Order M4 handle screws separately
- > Zinc alloy
- > Order qty: 1 pc



Finish	Cat. No.
 Polished chrome	131.27.260



# Jazz

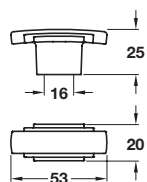

## JAZZ pull handle



- > Order M4 handle screws separately
- > Zinc alloy
- > Order qty: 1 pc



Finish	Cat. No.
 Polished chrome	<b>112.92.240</b>

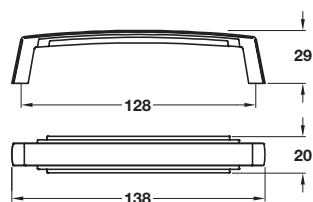

## JAZZ pull handle



- > Order M4 handle screws separately
- > Zinc alloy
- > Order qty: 1 pc



Finish	Cat. No.
 Polished chrome	<b>112.92.245</b>



Don't forget to order M4 handle screws, see page **353**  
 For our full range of fixing materials and installation tools see the Installation & Display section, pages **350-353**

## Swing

AT A GLANCE

KITCHEN APPLICATIONS

BEDROOM APPLICATIONS

BATHROOM APPLICATIONS

HANDLE FREE APPLICATIONS

INSTALLATION & DISPLAY

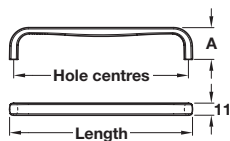

### SWING D handle

- > Order M4 handle screws separately
- > Zinc alloy
- > Order qty: 1 pc



Finish	Length	Hole centres	Dim. A	Cat. No.
Matt brass	72 mm	64 mm	28 mm	<b>111.71.500</b>
	168 mm	160 mm	29 mm	<b>111.71.501</b>
	328 mm	320 mm	29 mm	<b>111.71.502</b>



Don't forget to order M4 handle screws, see page **353**

For our full range of fixing materials and installation tools see the Installation & Display section, pages **350-353**

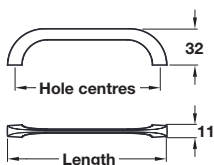

### CEYLON pull handle



- > 2x M4 x 25 mm and 2x M4 x 45 mm snap off handle screws included
- > Zinc alloy
- > Order qty: 1 pc



Finish	Length	Hole centres	Cat. No.
Brushed nickel	140 mm	128 mm	<b>102.18.735</b>
	332 mm	320 mm	<b>102.18.738</b>

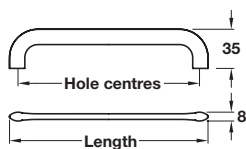

### CURLY D handle

- > Order M4 handle screws separately
- > Zinc alloy
- > Order qty: 1 pc



Finish	Length	Hole centres	Cat. No.
Matt black	79 mm	64 mm	<b>111.71.010</b>
	175 mm	160 mm	<b>111.71.011</b>
	335 mm	320 mm	<b>111.71.012</b>

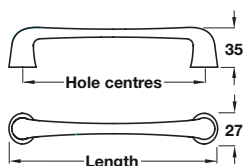

### TONDA D handle



- > Order M4 handle screws separately
- > Zinc alloy
- > Order qty: 1 pc



Finish	Length	Hole centres	Cat. No.
Polished nickel	184 mm	160 mm	<b>110.22.290</b>
	344 mm	320 mm	<b>110.22.291</b>

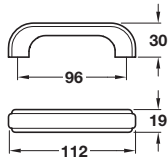

Product is subject to variations in colour and dimensions due to being manufactured from natural materials

### ADDA D handle

- > Order M4 handle screws separately
- > Unfinished wood
- > Order qty: 1 pc



Type of wood	Cat. No.
 Oak	<b>194.20.410</b>

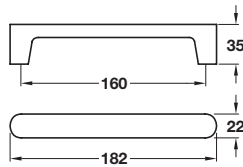

Product is subject to variations in colour and dimensions due to being manufactured from natural materials

### CONTACT handle

- > Order M4 handle screws separately
- > Walnut, lacquered
- > Order qty: 1 pc



Finish	Cat. No.
 Walnut	<b>193.18.766</b>

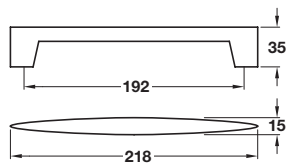

Product is subject to variations in colour and dimensions due to being manufactured from natural materials

### OVAL handle

- > Order M4 handle screws separately
- > Walnut, lacquered
- > Order qty: 1 pc



Finish	Cat. No.
 Walnut	<b>193.18.757</b>

➔ Don't forget to order M4 handle screws, see pages **21-23**  
For our full range of fixing materials and installation tools see the Installation & Display section, pages **21-23**



### EROS pull handle



- > Order M4 handle screws separately
- > Oak, lacquered
- > Order qty: 1 pc

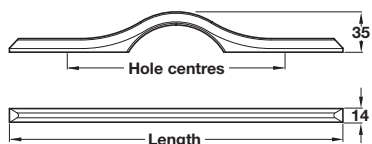

Product is subject to variations in colour and dimensions due to being manufactured from natural materials



Finish	Length	Hole centres	Cat. No.
Oak lacquered	294 mm	192 mm	<b>193.18.420</b>
	394 mm	256 mm	<b>193.18.421</b>
	594 mm	192/512 mm	<b>193.18.423</b>



### ULTRA pull handle



- > Order M4 handle screws separately
- > Ash
- > Order qty: 1 pc

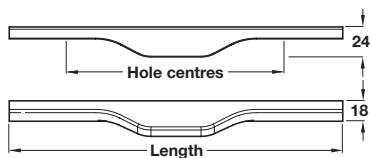

Product is subject to variations in colour and dimensions due to being manufactured from natural materials



Finish	Length	Hole centres	Cat. No.
Oak lacquered	294 mm	192 mm	<b>193.18.417</b>
	394 mm	256 mm	<b>193.18.418</b>
	594 mm	160/480 mm	<b>193.18.419</b>



### TWIST pull handle



- > Order M4 handle screws separately
- > Oak
- > Order qty: 1 pc

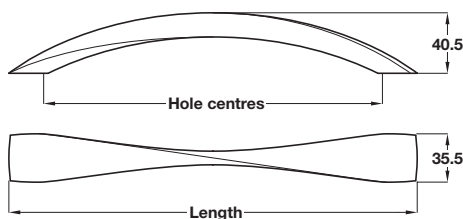

Product is subject to variations in colour and dimensions due to being manufactured from natural materials



Finish	Length	Hole centres	Cat. No.
Oak unfinished	270 mm	224 mm	<b>193.43.428</b>
	388 mm	320 mm	<b>193.43.429</b>

## Graf & Graf 2

AT A GLANCE

KITCHEN APPLICATIONS

BEDROOM APPLICATIONS

BATHROOM APPLICATIONS

HANDLE FREE APPLICATIONS

INSTALLATION & DISPLAY

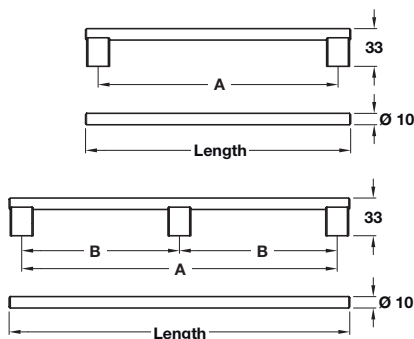

### GRAF 2 bar handle

- > 2/3x M4 x 25 mm handle screws included
- > Aluminium
- > Order qty: 1 pc



Finish	Length	Hole centres		Cat. No.
		A	B	
Stainless steel effect	182 mm	160 mm	-	<b>132.19.110</b>
	278 mm	256 mm	-	<b>132.19.111</b>
	1200 mm	1178 mm	589 mm	<b>132.19.112</b>
Black	182 mm	160 mm	-	<b>132.19.115</b>
	278 mm	256 mm	-	<b>132.19.116</b>
	1200 mm	1178 mm	589 mm	<b>132.19.117</b>
Brushed dark brass	182 mm	160 mm	-	<b>132.19.120</b>
	278 mm	256 mm	-	<b>132.19.121</b>
	1200 mm	1178 mm	589 mm	<b>132.19.122</b>

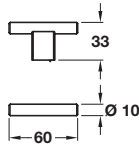

### GRAF 2 T knob



- > 1x M4 x 25 mm handle screw included
- > Aluminium
- > Order qty: 1 pc



Finish	Cat. No.
Stainless steel effect	132.19.105
Black	132.19.106
Brushed dark brass	132.19.107

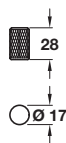

### GRAF knob



- > 1x M4 x 25 mm handle screw included
- > Aluminium
- > Order qty: 1 pc



Finish	Cat. No.
Polished chrome	132.15.230
Brushed brass	132.19.210
Matt black	132.19.211
Stainless steel effect	132.15.630
Brushed dark brass	106.60.318



### GRAF 2 cylindrical knob



- > 1x M4 x 25 mm handle screw included
- > Aluminium
- > Order qty: 1 pc



Finish	Cat. No.
Stainless steel effect	132.19.100
Black	132.19.101
Brushed dark brass	132.19.102

## Graf Big

AT A GLANCE

KITCHEN APPLICATIONS

BEDROOM APPLICATIONS

BATHROOM APPLICATIONS

HANDLE FREE APPLICATIONS

INSTALLATION & DISPLAY



Aspekt cabinet doors from Häfele - York matt midnight blue featured with Graf Big bar handles and knobs in dark brass finish

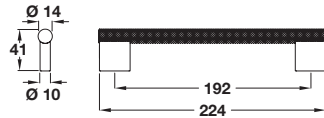

### GRAF BIG bar handle

- > 2x M4 x 25 mm handle screws included
- > Aluminium
- > Order qty: 1 pc



Finish	Cat. No.
Stainless steel effect	106.66.112
Brushed black	106.66.110
Brushed dark brass	106.66.111



### GRAF BIG knob

- > 1x M4 x 25 mm handle screw included
- > Aluminium
- > Order qty: 1 pc



Finish	Ø 38 mm	Ø 50 mm
Stainless steel effect	106.66.102	106.66.105
Brushed black	106.66.100	106.66.103
Dark brass	106.66.101	106.66.104



**+** View the full Aspekt cabinet doors range, visit [www.hafele.co.uk/aspekt-doors](http://www.hafele.co.uk/aspekt-doors)



# Flويد

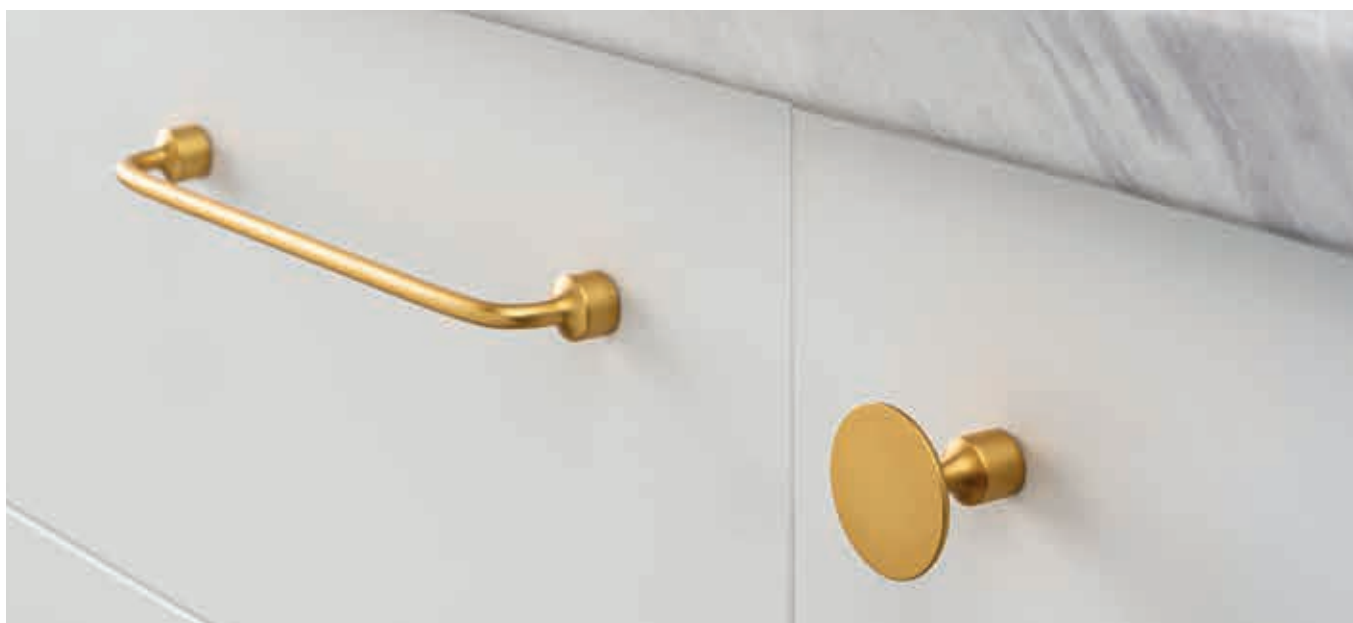

AT A GLANCE

KITCHEN APPLICATIONS

BEDROOM APPLICATIONS

BATHROOM APPLICATIONS

HANDLE FREE APPLICATIONS



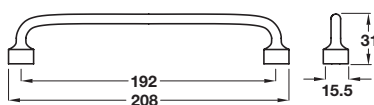

INSTALLATION & DISPLAY



### FLOID bar handle

- > 2x M4 x 25 mm handle screws included
- > Zinc alloy
- > Order qty: 1 pc







Finish	Cat. No.
 Brushed gold	106.60.300
 Pewter	106.60.301
 Antique brass	106.60.302
 Matt black	106.60.303



### FLOID knob

- > 1x M4 x 25 mm handle screw included
- > Zinc alloy
- > Order qty: 1 pc



Finish	Cat. No.
 Brushed gold	106.60.304
 Pewter	106.60.305
 Antique brass	106.60.306
 Matt black	106.60.307

## Firm

AT A GLANCE

KITCHEN APPLICATIONS

BEDROOM APPLICATIONS

BATHROOM APPLICATIONS

HANDLE FREE APPLICATIONS

INSTALLATION & DISPLAY

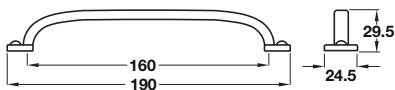

### FIRM D handle

- > 2x M4 x 25 mm handle screws included
- > Zinc alloy
- > Order qty: 1 pc



Finish	Cat. No.
 Textured black	<b>106.60.315</b>



# Tarvos, Encanto & Rhea

The Tarvos, Encanto and Rhea are textured furniture handles in a graphite finish with three designs of bar handles to choose from. Use to contrast or coordinate, the textured finish gives added style and makes the handle a pleasure to use

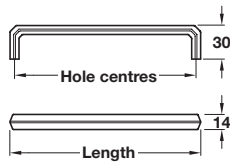
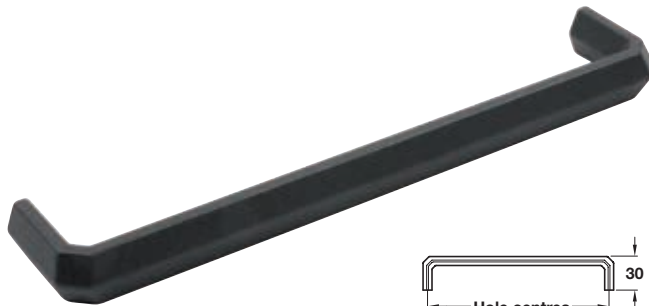

### TARVOS pull handle

- > 2x M4 x 22 mm handles screws included
- > Zinc alloy
- > Order qty: 1 pc



Finish	Length	Hole centres	Cat. No.
Matt black	136 mm	128 mm	<b>113.96.120</b>
	168 mm	160 mm	<b>113.96.121</b>

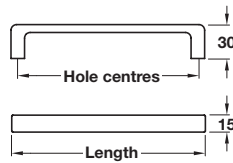

### ENCANTO pull handle

- > 2x M4 x 22 mm handles screws included
- > Zinc alloy
- > Order qty: 1 pc



Finish	Length	Hole centres	Cat. No.
Matt black	172 mm	160 mm	<b>113.96.100</b>
	332 mm	320 mm	<b>113.96.101</b>

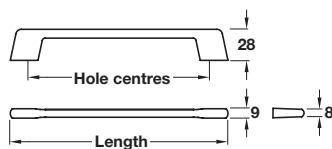

### RHEA pull handle

- > 2x M4 x 22 mm handles screws included
- > Zinc alloy
- > Order qty: 1 pc



Finish	Length	Hole centres	Cat. No.
Matt black	153 mm	128 mm	<b>113.96.110</b>
	185 mm	160 mm	<b>113.96.111</b>

FURNITURE HANDLES 2021, © Häfele U.K. Ltd 2021. Dimensional data not binding. We reserve the right to alter specifications without notice.

## U

AT A GLANCE

KITCHEN APPLICATIONS

BEDROOM APPLICATIONS

BATHROOM APPLICATIONS

HANDLE FREE APPLICATIONS

INSTALLATION & DISPLAY



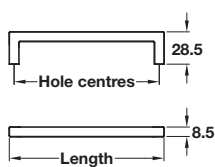

Aspekt cabinet doors from Häfele - Hampstead ultragloss cashmere featured with U pull handles in matt black finish



### U pull handle

- > 2x M4 x 25 mm handle screws included
- > Zinc alloy
- > Order qty: 1 pc



Finish	Length	Hole centres	Cat. No.
 Matt black	136.5 mm	128 mm	<b>108.66.385</b>
	200.5 mm	192 mm	<b>108.66.397</b>
	328.5 mm	320 mm	<b>108.66.386</b>
	500.5 mm	492 mm	<b>108.66.387</b>
 Polished chrome	136.5 mm	128 mm	<b>108.66.285</b>
	200.5 mm	192 mm	<b>108.66.380</b>
	328.5 mm	320 mm	<b>108.66.286</b>
	500.5 mm	492 mm	<b>108.66.287</b>
 Brushed brass	136.5 mm	128 mm	<b>108.66.388</b>
	200.5 mm	192 mm	<b>108.66.389</b>
	328.5 mm	320 mm	<b>108.66.390</b>
	500.5 mm	492 mm	<b>108.66.391</b>
 Brushed copper	136.5 mm	128 mm	<b>108.66.376</b>
	200.5 mm	192 mm	<b>108.66.377</b>
	328.5 mm	320 mm	<b>108.66.378</b>
	500.5 mm	492 mm	<b>108.66.379</b>

**+** View the full Aspekt cabinet doors range, visit [www.hafele.co.uk/aspekt-doors](http://www.hafele.co.uk/aspekt-doors)

Este



Aspekt cabinet doors from Häfele - Skye matt midnight blue featured with Este pull handles and Como knobs in brushed gold finish

AT A GLANCE

KITCHEN APPLICATIONS

BEDROOM APPLICATIONS

BATHROOM APPLICATIONS

HANDLE FREE APPLICATIONS

INSTALLATION & DISPLAY

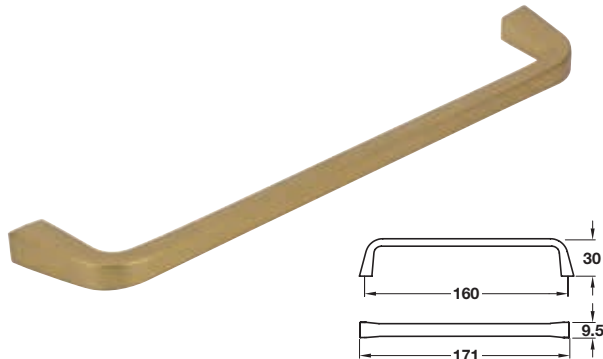

**ESTE pull handle**

- > 2x M4 x 25 mm handle screws included
- > Zinc alloy
- > Order qty: 1 pc



Finish	Cat. No.
 Matt black	108.66.456
 Brushed nickel	108.66.446
 Brushed gold	108.66.445
 Brushed copper	108.66.455



➔ The COMO knob shown on page 173 matches the ESTE pull handle

⊕ View the full Aspekt cabinet doors range, visit [www.hafele.co.uk/aspekt-doors](http://www.hafele.co.uk/aspekt-doors)

FURNITURE HANDLES 2021, © Häfele U.K. Ltd 2021. Dimensional data not binding. We reserve the right to alter specifications without notice.

## Olympia

AT A GLANCE

KITCHEN APPLICATIONS

BEDROOM APPLICATIONS

BATHROOM APPLICATIONS

HANDLE FREE APPLICATIONS

INSTALLATION & DISPLAY

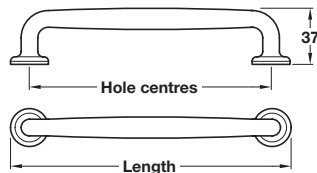

Note: ± 3 mm tolerance on non-critical dimensions and ±1 mm on hole centre dimensions  
Product is subject to variations in finish due to the finishing and manufacturing process of certain materials

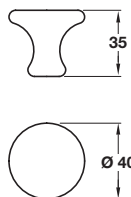

Note: ± 3 mm tolerance on non-critical dimensions  
Product is subject to variations in finish due to the finishing and manufacturing process of certain materials

### OLYMPIA pull handle

- > 2x M4 x 45 mm handle screws included
- > Pewter
- > Order qty: 1 pc



Finish	Length	Hole centres	Cat. No.
Pewter	185 mm	160 mm	<b>120.89.909</b>



### OLYMPIA knob

- > 1x M4 x 45 mm handle screw included
- > Pewter
- > Order qty: 1 pc



Finish	Cat. No.
Pewter	<b>120.89.908</b>



FURNITURE HANDLES 2021, © Häfele U.K. Ltd 2021. Dimensional data not binding. We reserve the right to alter specifications without notice.

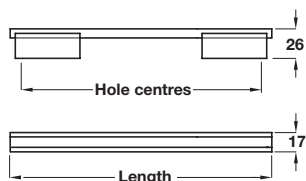

Product is subject to variations in finish due to the finishing and manufacturing process of certain materials

## MAYFAIR pull handle

- > 2x M4 handle screws included
- > Cast iron
- > Order qty: 1 pc



Finish	Length	Hole centres	Cat. No.
Antique pewter	132 mm	96 mm	<b>120.66.910</b>
	164 mm	128 mm	<b>120.66.902</b>
	196 mm	160 mm	<b>120.66.903</b>
	228 mm	192 mm	<b>120.66.904</b>
	260 mm	224 mm	<b>120.66.905</b>

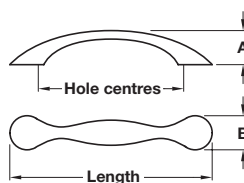

## WARWICK bow handle

- > Order M4 handle screws separately
- > Zinc alloy
- > Order qty: 1 pc



Finish	Length	Hole centres	Dim. A	Dim. B	Cat. No.
Antique pewter	137 mm	96 mm	28 mm	24.5 mm	<b>110.93.902</b>



Don't forget to order M4 handle screws, see page **353**

For our full range of fixing materials and installation tools see the Installation & Display section, pages **350-353**

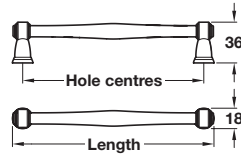

Note: ± 3 mm tolerance on non-critical dimensions and ±1 mm on hole centre dimensions  
Product is subject to variations in finish due to the finishing and manufacturing process of certain materials

## HERITAGE bar handle

- > 2x M4 x 25 mm handle screws included
- > Cast iron
- > Order qty: 1 pc



Finish	Length	Hole centres	Cat. No.
Natural iron	178 mm	160 mm	<b>120.66.956</b>

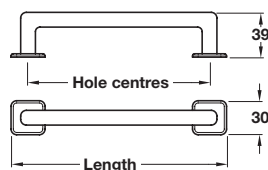

Note: ± 3 mm tolerance on non-critical dimensions and ±1 mm on hole centre dimensions  
Product is subject to variations in finish due to the finishing and manufacturing process of certain materials

## SALVADOR pull handle

- > 2x M4 x 45 mm M4 handle screws included
- > Pewter
- > Order qty: 1 pc



Finish	Length	Hole centres	Cat. No.
Pewter	188 mm	160 mm	<b>120.89.916</b>



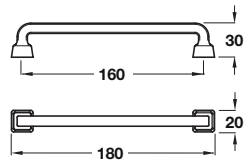

**BRERA D handle**



- > Order M4 handle screws separately
- > Zinc alloy
- > Order qty: 1 pc



Finish	Cat. No.
Satin nickel	110.22.274
Antique copper	110.22.275
Pewter	110.22.276

**Shapes**

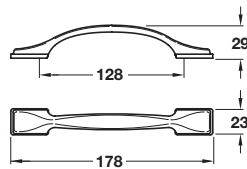

**SHAPES D handle**



- > Order M4 handle screws separately
- > Zinc alloy
- > Order qty: 1 pc



Finish	Cat. No.
Antique copper	110.22.277
Antique brass	110.22.278

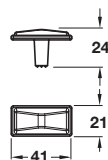

**SHAPES knob**



- > Order M4 handle screws separately
- > Zinc alloy
- > Order qty: 1 pc



Finish	Cat. No.
Antique copper	110.22.279
Antique brass	110.22.280

➔ Don't forget to order M4 handle screws, see page **353**  
 For our full range of fixing materials and installation tools see the Installation & Display section, pages **350-353**



FURNITURE HANDLES 2021, © Häfele U.K. Ltd 2021. Dimensional data not binding. We reserve the right to alter specifications without notice.

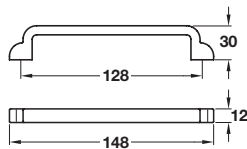

### THEODORE D pull handle

- > Order M4 handle screws separately
- > Zinc alloy
- > Order qty: 1 pc



Finish	Cat. No.
 Antique brass	106.61.143
 Antique tin	106.61.943
 Oil rubbed bronze	106.61.043



## BESPOKE TIMBER DRAWERS

Kitchen drawers are becoming an increasingly popular alternative to traditional cabinets. Our drawer range includes many different sizes and finishes, including a handcrafted, bespoke-sized timber option.



Walnut



Ply

Our Bespoke Timber Drawers are handmade in the UK from high grade solid timber. There are a number of design and personalisation choices available including a choice of wood types and come complete with dove-tailed joints.

The Häfele to Order service takes the manufacture, finishing, packaging and delivery off your hands, saving you time and money.



Oak

Find out more at [www.hafele.co.uk/bespoke-timber-drawers](http://www.hafele.co.uk/bespoke-timber-drawers)

# Burbridge



AT A GLANCE

KITCHEN APPLICATIONS

BEDROOM APPLICATIONS

BATHROOM APPLICATIONS

HANDLE FREE APPLICATIONS

INSTALLATION & DISPLAY

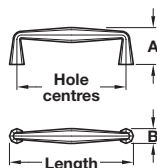

\*Product is subject to variations in finish due to the finishing and manufacturing process of certain materials

## BURBRIDGE pull handle



- > 2x M4 x 25 mm handle screws included
- > Brass or cast iron
- > Order qty: 1 pc



Finish	Length	Hole centres	Dim. A	Dim. B	Cat. No.
Polished nickel, brass	144 mm	128 mm	35 mm	15 mm	<b>116.35.745</b>
	176 mm	160 mm	37 mm	15 mm	<b>116.35.746</b>
Brushed brass, brass*	144 mm	128 mm	35 mm	15 mm	<b>116.35.545</b>
Antique copper, brass	144 mm	128 mm	35 mm	15 mm	<b>116.35.945</b>
Cast iron*	109 mm	96 mm	33 mm	13 mm	<b>116.35.344</b>
	212 mm	192 mm	40 mm	17 mm	<b>116.35.347</b>

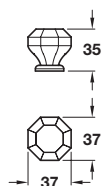

\*Product is subject to variations in finish due to the finishing and manufacturing process of certain materials

## BURBRIDGE knob



- > 1x M4 x 25 mm handle screw included
- > Brass
- > Order qty: 1 pc



Finish	Cat. No.
Brushed brass*	<b>123.03.510</b>
Polished nickel	<b>123.03.710</b>

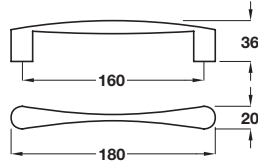

### DEVON D handle

- > Order M4 handle screws separately
- > Zinc alloy
- > Order qty: 1 pc



Finish	Cat. No.
 Stainless steel effect	101.42.003

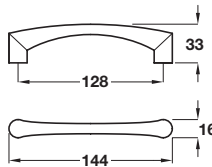

### EMERSON D handle

- > 2x M4 x 45 mm snap off handle screws included
- > Zinc alloy
- > Order qty: 1 pc



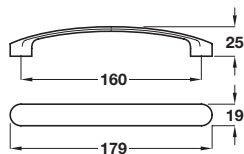

Finish	Cat. No.
 Matt nickel	101.71.022



### HARRINGTON D handle

- > 2x M4 x 45 mm snap off handle screws included
- > Zinc alloy
- > Order qty: 1 pc



Finish	Cat. No.
 Polished chrome	111.85.223
 Stainless steel effect	111.85.023

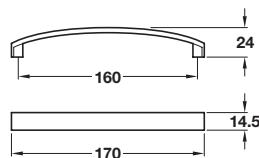

### SAFFRON bow handle

- > Order M4 handle screws separately
- > Aluminium
- > Order qty: 1 pc



Finish	Cat. No.
 Polished chrome	109.53.216

# Caleido



AT A GLANCE

KITCHEN APPLICATIONS

BEDROOM APPLICATIONS

BATHROOM APPLICATIONS

HANDLE FREE APPLICATIONS

INSTALLATION & DISPLAY

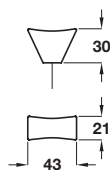
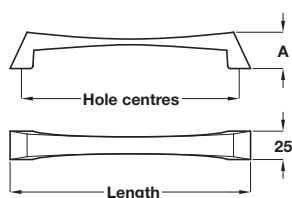

## CALEIDO D handle

- > 2x M4 x 25 mm handle screws included
- > Zinc alloy
- > Order qty: 1 pc



Finish	Length	Hole centres	Dim. A	Cat. No.
St. steel effect	150 mm	128 mm	31 mm	<b>110.22.662</b>
	214 mm	192 mm	32 mm	<b>110.22.664</b>
	342 mm	320 mm	34 mm	<b>110.22.668</b>
Polished chrome	150 mm	128 mm	31 mm	<b>110.22.262</b>
	214 mm	192 mm	32 mm	<b>110.22.268</b>
	342 mm	320 mm	34 mm	<b>110.22.268</b>

## CALEIDO knob

- > 1x M4 x 25 mm handle screw included
- > Zinc alloy
- > Order qty: 1 pc



Finish	Cat. No.
Stainless steel effect	<b>131.10.620</b>
Polished chrome	<b>131.10.220</b>

## Colibri

AT A GLANCE

KITCHEN APPLICATIONS

BEDROOM APPLICATIONS

BATHROOM APPLICATIONS

HANDLE FREE APPLICATIONS

INSTALLATION & DISPLAY

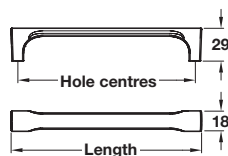

### COLIBRI pull handle

- > 2x M4 x 25 mm handle screws included
- > Zinc alloy
- > Order qty: 1 pc



Finish	Length	Hole centres	Cat. No.
Polished chrome	170 mm	160 mm	<b>111.62.226</b>
	330 mm	320 mm	<b>111.62.229</b>
Stainless steel effect	170 mm	160 mm	<b>111.62.426</b>
	330 mm	320 mm	<b>111.62.429</b>



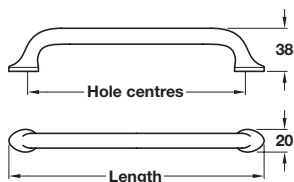

Note: ± 3 mm tolerance on non-critical dimensions and ±1 mm on hole centre dimensions

### RIO pull handle

- > 2x M4 x 25 mm handle screws included
- > Brass
- > Order qty: 1 pc



Finish	Length	Hole centres	Cat. No.
Polished nickel	192 mm	160 mm	<b>119.29.706</b>

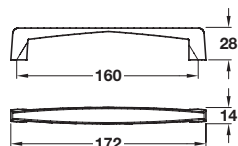

### FALSTAFF pull handle

- > Order M4 handle screws separately
- > Zinc alloy
- > Order qty: 1 pc



Finish	Cat. No.
Polished chrome	<b>102.18.206</b>

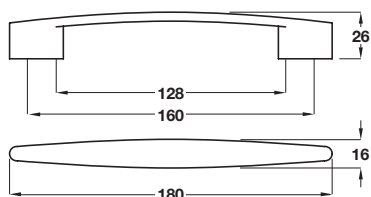

### MONTROSE D pull handle

- > Order M4 handle screws separately
- > Zinc alloy
- > Order qty: 1 pc



Finish	Cat. No.
Polished chrome	<b>110.34.236</b>



Don't forget to order M4 handle screws, see page **353**

For our full range of fixing materials and installation tools see the Installation & Display section, pages **350-353**

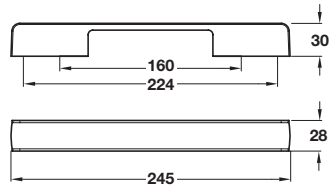

### BLANCO D handle

- > Order M4 handle screws separately
- > Zinc alloy, with acrylic centres
- > Order qty: 1 pc



Finish	Cat. No.
 Polished chrome with white insert	<b>111.21.273</b>



### NOIR D handle

- > Order M4 handle screws separately
- > Zinc alloy, with acrylic centres
- > Order qty: 1 pc



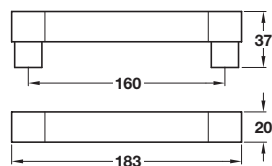

Finish	Cat. No.
 Polished chrome with black insert	<b>111.21.233</b>



### DOMINO bar handle

- > Order M4 handle screws separately
- > Zinc alloy, polished chrome with leather effect centre
- > Order qty: 1 pc



Finish	Length	Hole centres	Cat. No.
 Black	151 mm	128 mm	<b>113.98.232</b>
	183 mm	160 mm	<b>113.98.233</b>
 Brown	151 mm	128 mm	<b>113.98.212</b>
	247 mm	224 mm	<b>113.98.215</b>



Don't forget to order M4 handle screws, see page **353**  
For our full range of fixing materials and installation tools see the Installation & Display section, pages **350-353**



# Crystal

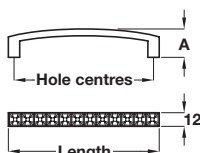

## CRYSTAL D handle

- > Order M4 handle screws separately
- > Made with CRYSTALLIZED™ Swarovski Elements
- > Zinc alloy
- > Order qty: 1 pc



Finish	Length	Hole centres	Dim. A	Cat. No.
	107 mm	96 mm	22 mm	<b>103.29.221</b>
	140 mm	128 mm	25 mm	<b>103.29.222</b>

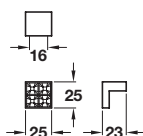

## CRYSTAL pull handle

- > Order M4 handle screws separately
- > Made with CRYSTALLIZED™ Swarovski Elements
- > Zinc alloy
- > Order qty: 1 pc



Finish	Cat. No.
Polished chrome	<b>132.19.240</b>

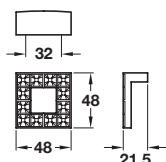

## CRYSTAL pull handle

- > 2x M4 x 25 mm handle screws included
- > Made with CRYSTALLIZED™ Swarovski Elements
- > Zinc alloy
- > Order qty: 1 pc



Finish	Cat. No.
Polished chrome	<b>132.19.220</b>

FURNITURE HANDLES 2021, © Häfele U.K. Ltd 2021. Dimensional data not binding. We reserve the right to alter specifications without notice.

## Glacio

AT A GLANCE

KITCHEN APPLICATIONS

BEDROOM APPLICATIONS

BATHROOM APPLICATIONS

HANDLE FREE APPLICATIONS

INSTALLATION & DISPLAY

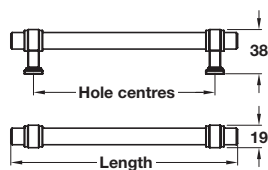

### GLACIO pull handle

- > 2x 8/32 x 1" (non-metric) screws included
- > Zinc/Glass
- > Order qty: 1 pc



Finish	Length	Hole centres	Cat. No.
	167 mm	128 mm	<b>133.53.039</b>
	200 mm	160 mm	<b>133.53.040</b>

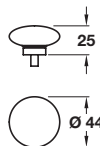

### GLACIO knob

- > 1x 8/32 x 1" (non-metric) screw included
- > Zinc/Glass
- > Order qty: 1 pc



Finish	Cat. No.
 Polished nickel / Clear	<b>133.50.122</b>

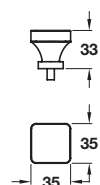

### GLACIO square knob

- > 1x 8/32 x 1" (non-metric) screw included
- > Zinc/Glass
- > Order qty: 1 pc



Finish	Cat. No.
 Polished nickel / Clear	<b>133.50.120</b>



All handles on this page include 8/32 x 1" (non-metric) screws. If you require a different length order non-metric cut off screw Cat. No. 022.24.881 shown on page **353**

# Byron

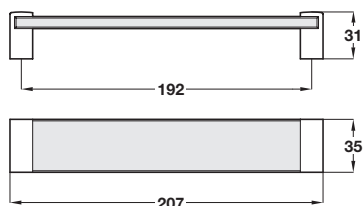

## BYRON bar handle

- > 2x M4 x 25 mm handle screws included
- > Zinc alloy, with tempered glass
- > Order qty: 1 pc



Finish	Cat. No.
 Polished chrome with clear glass	108.80.507

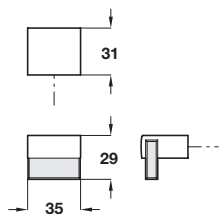

## BYRON knob

- > 1x M4 x 25 mm handle screw included
- > Zinc alloy, with tempered glass
- > Order qty: 1 pc



Finish	Cat. No.
 Polished chrome with clear glass	131.14.200

## Glitter

AT A GLANCE

KITCHEN APPLICATIONS

BEDROOM APPLICATIONS

BATHROOM APPLICATIONS

HANDLE FREE APPLICATIONS

INSTALLATION & DISPLAY

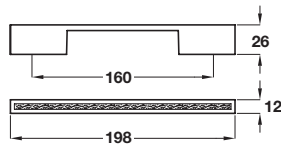

### GLITTER D handle

- > Order M4 handle screws separately
- > Zinc alloy
- > Order qty: 1 pc



Finish	Cat. No.
 Polished chrome with glitter inner, sealed	<b>110.22.253</b>

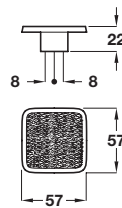

### GLITTER knob

- > Order M4 handle screws separately
- > Zinc alloy
- > Order qty: 1 pc



Finish	Cat. No.
 Polished chrome with glitter inner, sealed	<b>132.15.220</b>



### GLITTER knob

- > Order M4 handle screws separately
- > Zinc alloy
- > Order qty: 1 pc



Finish	Cat. No.
 Polished chrome with glitter inner, sealed	<b>132.15.210</b>

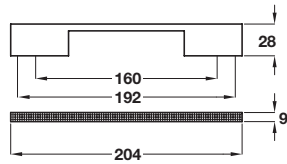

**DISCO pull handle**

- > Order M4 handle screws separately
- > Zinc alloy
- > Order qty: 1 pc



Finish	Cat. No.
 Polished chrome	<b>110.22.243</b>



## BESPOKE TIMBER DRAWERS

Kitchen drawers are becoming an increasingly popular alternative to traditional cabinets. Our drawer range includes many different sizes and finishes, including a handcrafted, bespoke-sized timber option.



Walnut



Ply

Our Bespoke Timber Drawers are handmade in the UK from high grade solid timber. There are a number of design and personalisation choices available including a choice of wood types and come complete with dove-tailed joints.

The Häfele to Order service takes the manufacture, finishing, packaging and delivery off your hands, saving you time and money.



Oak

Find out more at [www.hafele.co.uk/bespoke-timber-drawers](http://www.hafele.co.uk/bespoke-timber-drawers)

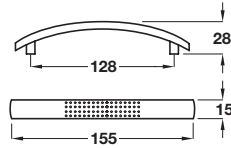
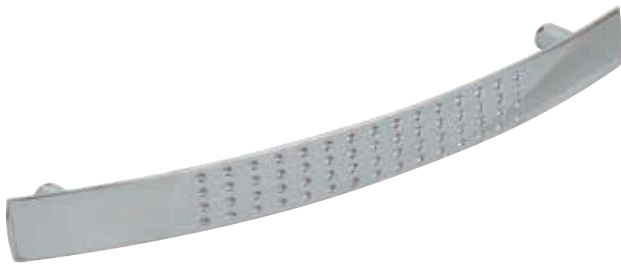

### DOTTY lightweight bow handle

- > Order M4 handle screws separately
- > Zinc alloy
- > Order qty: 1 pc



Finish	Cat. No.
 Polished chrome	101.69.262

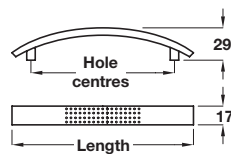

## Dimple



### DIMPLE bow handle

- > Order M4 handle screws separately
- > Zinc alloy
- > Order qty: 1 pc



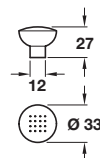

Finish	Length	Hole centres	Cat. No.
 Polished chrome	126 mm	96 mm	101.69.201
	158 mm	128 mm	101.69.202
 Matt nickel	126 mm	96 mm	101.69.601
	158 mm	128 mm	101.69.602
 Stainless steel effect	126 mm	96 mm	101.69.001
	158 mm	128 mm	101.69.002



### DIMPLE knob

- > Order M4 handle screws separately
- > \*1x M4 x 25 mm screw included
- > Zinc alloy
- > Order qty: 1 pc



Finish	Cat. No.
 Polished chrome	135.48.202
 Matt nickel	135.48.402
 Stainless steel effect	135.48.002*

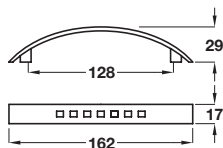

### ANTROBUS bow handle

- > Order M4 handle screws separately
- > Zinc alloy
- > Order qty: 1 pc



Finish	Cat. No.
Matt nickel plated	105.07.501

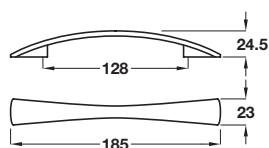

### QUIGLEY bow handle

- > Order M4 handle screws separately
- > Zinc alloy
- > Order qty: 1 pc



Finish	Cat. No.
Polished chrome	109.29.202
Matt nickel	109.29.602
Aluminium coloured	109.29.402

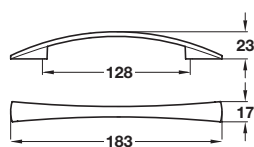

### OCTAVIA lightweight bow handle

- > Order M4 handle screws separately
- > Zinc alloy
- > Order qty: 1 pc



Finish	Cat. No.
Matt nickel	102.33.605
Polished chrome	102.33.205



Don't forget to order M4 handle screws, see page **353**  
For our full range of fixing materials and installation tools see the Installation & Display section, pages **350-353**

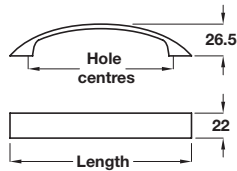

### LEWIS bow handle

- > Order M4 handle screws separately
- > Zinc alloy
- > Order qty: 1 pc



Finish	Length	Hole centres	Cat. No.
Stainless steel effect	160 mm	128 mm	<b>107.72.602</b>
	193 mm	160 mm	<b>107.72.603</b>

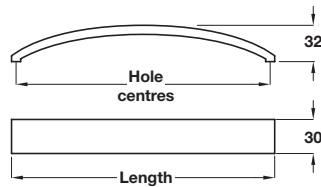

### BELMONT bow handle

- > Order M4 handles screws separately
- > Aluminium
- > Order qty: 1 pc



Finish	Length	Hole centres	Cat. No.
Stainless steel effect	232 mm	224 mm	<b>110.20.635</b>
	335 mm	320 mm	<b>110.20.638</b>

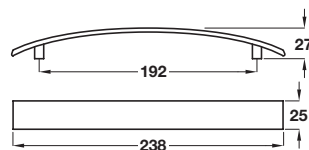

### CICERO bow handle

- > Order M4 handle screws separately
- > Zinc alloy
- > Order qty: 1 pc



Finish	Cat. No.
Stainless steel effect	<b>102.35.034</b>



Don't forget to order M4 handle screws, see page **353**  
 For our full range of fixing materials and installation tools see the Installation & Display section, pages **350-353**



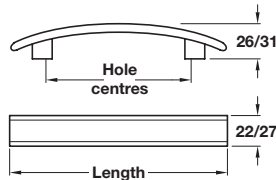

### DARIA bow handle

- > 2x M4 x 45 mm snap off handle screws included
- > Zinc alloy, polished chrome/stainless steel effect finish
- > Order qty: 1 pc



Finish	Length	Hole centres	Cat. No.
Polished chrome	144 mm	96 mm	<b>102.34.251</b>
	192 mm	128 mm	<b>102.34.262</b>

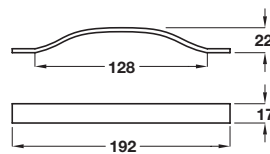

### JACKSON bow handle

- > 2x M4 x 25 mm handle screws included
- > \*2x M4 x 22 mm and 2 x M4 x 26 mm handle screws included
- > Zinc alloy
- > Order qty: 1 pc



Finish	Cat. No.
Polished chrome	<b>106.75.203</b>
Polished nickel	<b>106.75.603*</b>

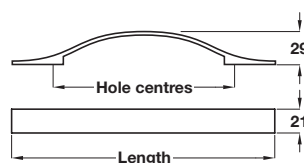

### CHISWICK bow handle

- > Order M4 handle screws separately
- > Zinc alloy
- > Order qty: 1 pc



Finish	Length	Hole centres	Cat. No.
Polished chrome	232 mm	160 mm	<b>108.89.243</b>
Stainless steel effect			<b>108.89.043</b>



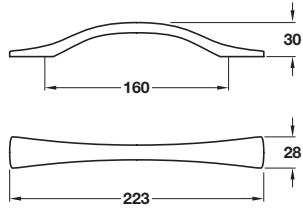

### TARA bow handle

- > Order M4 handle screws separately
- > Zinc alloy
- > Order qty: 1 pc



Finish	Cat. No.
 Matt nickel	<b>105.77.603</b>

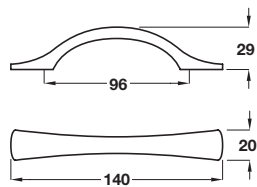

### EMILY bow handle

- > Order M4 handle screws separately
- > Zinc alloy
- > Order qty: 1 pc



Finish	Cat. No.
 Matt nickel	<b>104.38.601</b>

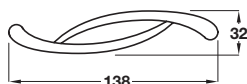
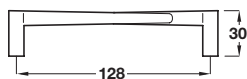

### SOPHIA pull handle

- > Order M4 handle screws separately
- > Zinc alloy
- > Order qty: 1 pc



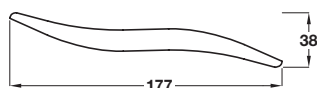

Finish	Cat. No.
 Matt nickel	101.50.602



### SILAS bar handle

- > Order M4 handle screws separately
- > Zinc alloy
- > Order qty: 1 pc



Finish	Cat. No.
 Matt nickel	103.36.600
 Polished chrome	103.36.201



Don't forget to order M4 handle screws, see page **353**

For our full range of fixing materials and installation tools see the Installation & Display section, pages **350-353**

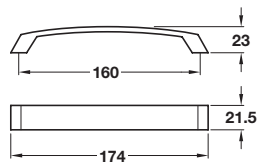

### TAVISTOCK bow handle

- > 2 each of M4 x 22 mm and M4 x 25 mm handle screws included
- > \*2x M4 x 45 mm snap off handle screws included
- > Aluminium
- > Order qty: 1 pc



Finish	Cat. No.
Polished chrome	<b>109.53.226</b>
Stainless steel effect	<b>109.53.626*</b>

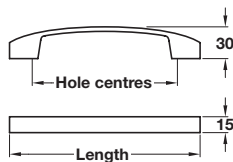

### FLORENCE bow handle

- > Order M4 handle screws separately
- > Aluminium
- > Order qty: 1 pc



Finish	Length	Hole centres	Cat. No.
Stainless steel effect	168 mm	128 mm	<b>109.53.635</b>
	200 mm	160 mm	<b>109.53.636</b>

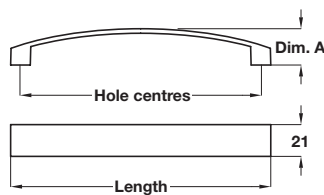

### MELBURY bow handle

- > Order M4 handle screws separately
- > Zinc alloy
- > Order qty: 1 pc



Finish	Length	Hole centres	Dim. A	Cat. No.
Stainless steel effect	141 mm	128 mm	22 mm	<b>113.82.015</b>
	172 mm	160 mm	23 mm	<b>113.82.016</b>
	268 mm	256 mm	23 mm	<b>113.82.019</b>
Polished chrome	268 mm	256 mm	23 mm	<b>113.82.219</b>

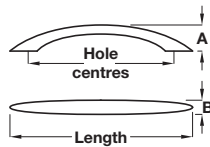

### MANILIA bow handle

- > Order M4 handle screws separately
- > Zinc alloy
- > Order qty: 1 pc



Finish	Length	Hole centres	Dim. A	Dim. B	Cat. No.
Matt nickel	126 mm	96 mm	23.5 mm	12 mm	<b>105.65.601</b>
	156 mm	128 mm	23.5 mm	12.7 mm	<b>103.78.603</b>
	222 mm	192 mm	29.5 mm	13.9 mm	<b>101.08.600</b>
Aluminium coloured	126 mm	96 mm	23.5 mm	12 mm	<b>105.65.401</b>

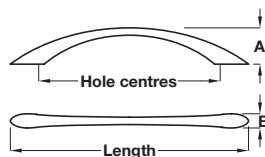

### SABINE bow handle

- > Order M4 handle screws separately
- > Zinc alloy
- > Order qty: 1 pc



Finish	Length	Hole centres	Dim. A	Dim. B	Cat. No.
Matt nickel	154.9 mm	128 mm	28 mm	10.8 mm	<b>103.84.604</b>
	204 mm	160 mm	30 mm	12.5 mm	<b>105.16.605</b>
	288 mm	224 mm	32 mm	16 mm	<b>101.07.600</b>
Silver RAL 9006	154.9 mm	128 mm	28 mm	10.8 mm	<b>103.84.214</b>



Don't forget to order M4 handle screws, see page **353**  
 For our full range of fixing materials and installation tools see the Installation & Display section, pages **350-353**

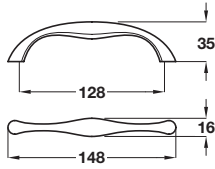

### GRACE bow handle

- > Order M4 handle screws separately
- > Zinc alloy
- > Order qty: 1 pc



Finish	Cat. No.
 Stainless steel effect	<b>102.89.620</b>

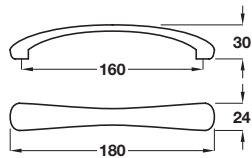

### AUBREY bow handle

- > Order M4 handle screws separately
- > Zinc alloy
- > Order qty: 1 pc



Finish	Cat. No.
 Matt nickel	<b>109.13.603</b>

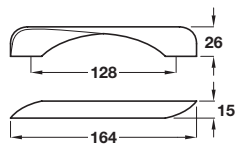

### REMUS bow handle

- > 2x M4 x 25 mm handle screws included
- > Zinc alloy
- > Order qty: 1 pc



Finish	Cat. No.
 Matt nickel	<b>102.83.650</b>



Don't forget to order M4 handle screws, see page **353**  
For our full range of fixing materials and installation tools see the Installation & Display section, pages **350-353**

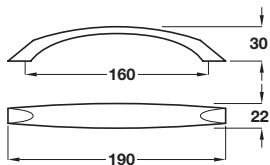

### KAYLA bow handle

- > 2x M4 x 25 mm snap off handle screws included
- > Zinc alloy
- > Order qty: 1 pc



Finish	Cat. No.
 Stainless steel effect	<b>108.77.053</b>

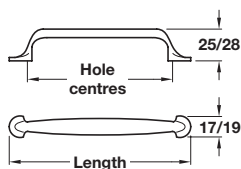

### LOGAN D handle

- > 2x M4 x 45 mm snap off handle screws included
- > Zinc alloy
- > Order qty: 1 pc



Finish	Length	Hole centres	Cat. No.
 Stainless steel effect	125 mm	96 mm	<b>102.85.610</b>
	162 mm	128 mm	<b>102.85.620</b>

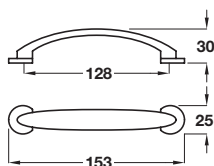

### BRADLEY bow handle

- > Order M4 handle screws separately
- > Zinc alloy
- > Order qty: 1 pc



Finish	Cat. No.
 Matt nickel	<b>107.18.603</b>

## Arco

AT A GLANCE

KITCHEN APPLICATIONS

BEDROOM APPLICATIONS

BATHROOM APPLICATIONS

HANDLE FREE APPLICATIONS

INSTALLATION & DISPLAY

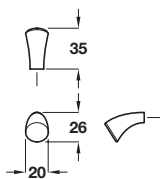
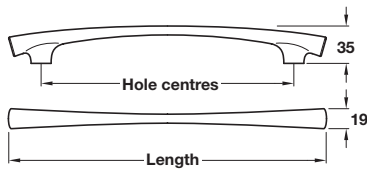

### ARCO bow handle

- > Order M4 handle screws separately
- > Zinc alloy
- > Order qty: 1 pc



Finish	Length	Hole centres	Cat. No.
Stainless steel effect	185 mm	128 mm	<b>111.62.612</b>
	281 mm	224 mm	<b>111.62.615</b>
Polished chrome	185 mm	128 mm	<b>111.62.212</b>
	281 mm	224 mm	<b>111.62.215</b>



### ARCO knob

- > Order M4 handle screws separately
- > Zinc alloy
- > Order qty: 1 pc



Finish	Cat. No.
Stainless steel effect	<b>133.91.610</b>





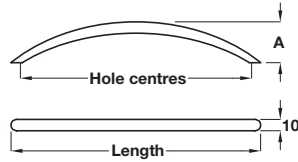

### INDIGO bow handle

- > Order M4 handle screws separately
- > Steel
- > Order qty: 1 pc



Finish	Length	Hole centres	Dim. A	Cat. No.
Polished chrome	111 mm	96 mm	30 mm	<b>117.31.222</b>
	148 mm	128 mm	30 mm	<b>117.31.231</b>
	184 mm	160 mm	32 mm	<b>117.31.241</b>
	297 mm	256 mm	32 mm	<b>117.31.261</b>
Matt black	151 mm	128 mm	30 mm	<b>106.43.302</b>
	187 mm	160 mm	32 mm	<b>106.43.303</b>

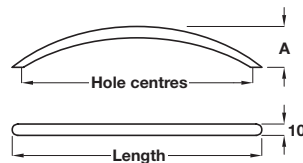

### Bow handle

- > Order M4 handle screws separately
- > Steel
- > Order qty: 1 pc



Finish	Length	Hole centres	Dim. A	Cat. No.
Aluminium coloured	118 mm	96 mm	24 mm	<b>106.43.401</b>
	151 mm	128 mm	30 mm	<b>106.43.402</b>
	187 mm	160 mm	32 mm	<b>106.43.403</b>
	320 mm	288 mm	40 mm	<b>106.43.407</b>
Polished brass	118 mm	96 mm	24 mm	<b>106.43.801</b>
	151 mm	128 mm	30 mm	<b>106.43.802</b>
	187 mm	160 mm	32 mm	<b>106.43.803</b>
	320 mm	288 mm	40 mm	<b>106.43.807</b>



Don't forget to order M4 handle screws, see page **353**  
 For our full range of fixing materials and installation tools see the Installation & Display section, pages **350-353**

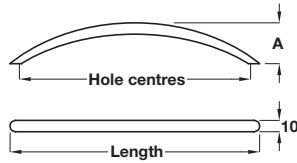

### CEDAR bow handle

- > Order M4 handle screws separately
- > Steel
- > Order qty: 1 pc



Finish	Length	Hole centres	Dim. A	Cat. No.
Matt chrome	111 mm	96 mm	30 mm	<b>117.31.421</b>
	148 mm	128 mm	30 mm	<b>117.31.431</b>
	184 mm	160 mm	32 mm	<b>117.31.441</b>

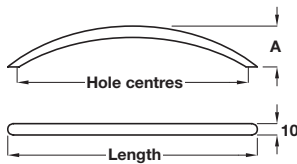

### CLIFTON bow handle

- > Order M4 handle screws separately
- > \*2x M4 handle screws included
- > Steel
- > Order qty: 1 pc



Finish	Length	Hole centres	Dim. A	Cat. No.
Brushed stainless steel effect	111 mm	96 mm	30 mm	<b>117.31.021</b>
	148 mm	128 mm	30 mm	<b>117.31.031*</b>
	184 mm	160 mm	32 mm	<b>117.31.041</b>
	221 mm	192 mm	32 mm	<b>117.31.052</b>
	258 mm	224 mm	32 mm	<b>117.31.053</b>
	332 mm	288 mm	32 mm	<b>117.31.071</b>



Don't forget to order M4 handle screws, see page **353**  
 For our full range of fixing materials and installation tools see the Installation & Display section, pages **350-353**

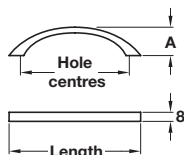

### CORDELIA bow handle

- > Order M4 handle screws separately
- > Zinc alloy
- > Order qty: 1 pc



Finish	Length	Hole centres	Dim. A	Cat. No.
Polished chrome	86.5 mm	64 mm	19 mm	<b>107.66.210</b>
	150 mm	128 mm	31 mm	<b>107.66.212</b>
	186 mm	160 mm	31.5 mm	<b>107.66.213</b>
	318 mm	288 mm	38.5 mm	<b>107.66.217</b>

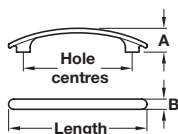

### HUDSON bow handle

- > 2x M4 x 45 mm snap off screws included
- > Zinc alloy
- > Order qty: 1 pc



Finish	Length	Hole centres	Dim. A	Cat. No.
Polished chrome	90 mm	64 mm	19 mm	<b>102.34.210</b>
	123 mm	96 mm	21 mm	<b>102.34.211</b>
	157 mm	128 mm	22 mm	<b>102.34.212</b>
	190 mm	160 mm	24 mm	<b>102.34.213</b>
	256 mm	224 mm	27 mm	<b>102.34.215</b>
	320 mm	288 mm	33 mm	<b>102.34.217</b>

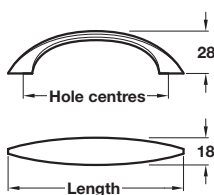

### ELMER bow handle

- > 2x M4 x 25 mm handle screws included
- > \*2x M4 x 45 mm snap off handle screws included
- > Zinc alloy
- > Order qty: 1 pc



Finish	Length	Hole centres	Cat. No.
Stainless steel effect	118 mm	96 mm	<b>102.03.601</b>
	150 mm	128 mm	<b>102.03.602*</b>

## Raviolo

AT A GLANCE

KITCHEN APPLICATIONS

BEDROOM APPLICATIONS

BATHROOM APPLICATIONS

HANDLE FREE APPLICATIONS

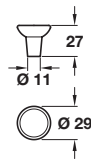
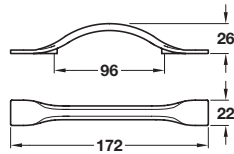

INSTALLATION & DISPLAY



### RAVIOLO bow handle

- > 2x M4 x 25 mm handle screws included
- > Zinc alloy
- > Order qty: 1 pc





Finish	Cat. No.
 Pewter	106.69.295
 Antique bronze	106.69.296



### RAVIOLO knob

- > 1x M4 x 25 mm handle screw included
- > Zinc alloy
- > Order qty: 1 pc



Finish	Cat. No.
 Pewter	106.69.300
 Antique bronze	106.69.301





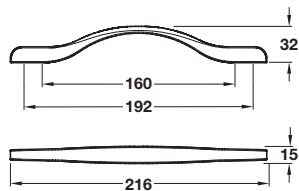

### HENLEY bow handle

- > Order M4 handle screws separately
- > Zinc alloy
- > Order qty: 1 pc



Finish	Cat. No.
 Light bronze	108.89.116
 Graphite	108.89.516



Don't forget to order M4 handle screws, see page **353**  
 For our full range of fixing materials and installation tools see the Installation & Display section, pages **350-353**

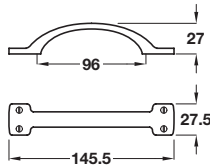

### FABIAN bow handle

- > 2x M4 x 25 mm and 2x M4 x 45 mm handle screws included
- > Zinc alloy
- > Order qty: 1 pc



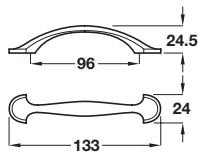

Finish	Cat. No.
 Pewter	<b>101.39.901</b>



### NORFOLK bow handle

- > Order M4 handle screws separately
- > Zinc alloy
- > Order qty: 1 pc



Finish	Cat. No.
 Antique brass	<b>101.85.102</b>
 Antique pewter	<b>101.85.902</b>

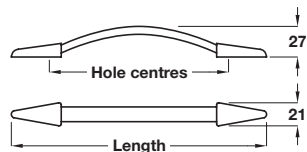

Product is subject to variations in finish due to the finishing and manufacturing process of certain materials

### SHERWOOD bow handle

- > 2x M4 handle screws included
- > Cast iron
- > Order qty: 1 pc



Finish	Length	Hole centres	Cat. No.
 Iron	192 mm	128 mm	<b>120.67.902</b>
	224 mm	160 mm	<b>120.67.903</b>





Don't forget to order M4 handle screws, see page **353**  
For our full range of fixing materials and installation tools see the Installation & Display section, pages **350-353**

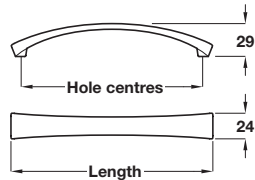

**TAPER bow handle**

- > 2x M4 handle screws included
- > Cast iron
- > Order qty: 1 pc



Finish	Length	Hole centres	Cat. No.
 Iron	181 mm	160 mm	<b>120.64.013</b>

Product is subject to variations in finish due to the finishing and manufacturing process of certain materials



## BESPOKE TIMBER DRAWERS

Kitchen drawers are becoming an increasingly popular alternative to traditional cabinets. Our drawer range includes many different sizes and finishes, including a handcrafted, bespoke-sized timber option.



Our Bespoke Timber Drawers are handmade in the UK from high grade solid timber. There are a number of design and personalisation choices available including a choice of wood types and come complete with dove-tailed joints.

The Häfele to Order service takes the manufacture, finishing, packaging and delivery off your hands, saving you time and money.



Find out more at [www.hafele.co.uk/bespoke-timber-drawers](http://www.hafele.co.uk/bespoke-timber-drawers)

## Knightsbridge

AT A GLANCE

KITCHEN APPLICATIONS

BEDROOM APPLICATIONS

BATHROOM APPLICATIONS

HANDLE FREE APPLICATIONS

INSTALLATION & DISPLAY

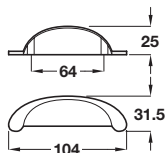

### KNIGHTSBRIDGE cup handle

- > Order M4 handle screws separately
- > Zinc alloy
- > Order qty: 1 pc



Finish	Cat. No.
 Stainless steel effect	118.55.620

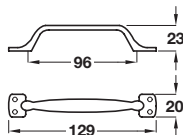

### KNIGHTSBRIDGE D handle

- > Order M4 handle screws separately
- > Zinc alloy
- > Order qty: 1 pc



Finish	Cat. No.
 Stainless steel effect	118.69.620



Don't forget to order M4 handle screws, see page **353**  
For our full range of fixing materials and installation tools see the Installation & Display section, pages **350-353**



# Rochdale

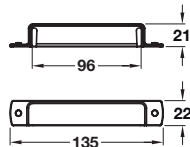

## ROCHDALE cup handle



- > 2x 8/32 x 1" (non-metric) screws included
- > Zinc alloy
- > Order qty: 1 pc



Finish	Cat. No.
 Satin nickel	133.50.142

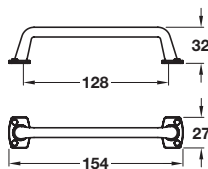

## ROCHDALE pull handle



- > 2x 8/32 x 1" (non-metric) screws included
- > Zinc alloy
- > Order qty: 1 pc



Finish	Cat. No.
 Satin nickel	133.50.370

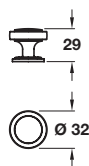

## ROCHDALE knob



- > 1x 8/32 x 1" (non-metric) screw included
- > Zinc alloy
- > Order qty: 1 pc



Finish	Cat. No.
 Satin nickel	133.50.632



All handles on this page include 8/32 x 1" (non-metric) screws. If you require a different length order non-metric cut off screw Cat. No. 022.24.881 shown on page 353

## Henrietta

AT A GLANCE

KITCHEN APPLICATIONS

BEDROOM APPLICATIONS

BATHROOM APPLICATIONS

HANDLE FREE APPLICATIONS

INSTALLATION & DISPLAY

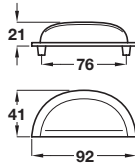

The MAYBERRY knob shown on page 133 also matches the HENRIETTA cup handle

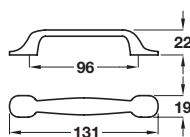
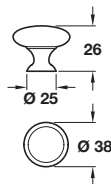

### HENRIETTA cup handle



- > 2x M4 x 25 mm and 2x M4 x 45 mm snap off handle screws included
- > \*Order M4 handle screws separately
- > Zinc alloy
- > Order qty: 1 pc



Finish	Cat. No.
Polished chrome	166.11.204*
Stainless steel effect	166.11.400*
Polished black nickel	166.11.305

### HENRIETTA knob



- > 1x M4 x 25 mm handle screw included
- > Zinc alloy
- > Order qty: 1 pc



Finish	Cat. No.
Polished chrome	134.39.210
Stainless steel effect	134.39.020

### HENRIETTA D handle



- > 2x M4 x 25 mm handles screws and 2x M4 x 45 mm snap off handle screws included
- > \*Order fixing screws separately
- > Aluminium
- > Order qty: 1 pc



Finish	Cat. No.
Polished chrome	109.48.224
Stainless steel effect	118.53.600*

# Ariel

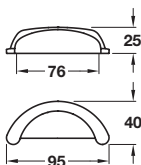

## ARIEL cup handle



- > 2 each of M4 x 20 mm, 22 mm and 27 mm handle screws included
- > \*Order fixing screws separately for polished chrome finish
- > Zinc alloy
- > Order qty: 1 pc



Finish	Cat. No.
Polished chrome	166.11.240*
Pewter effect	166.11.905

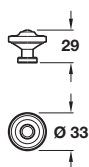

## ARIEL knob



- > 1 each of M4 x 22 mm and 27 mm handle screws included
- > \*Order fixing screws separately for polished chrome finish
- > Zinc alloy
- > Order qty: 1 pc



Finish	Cat. No.
Polished chrome	134.06.200*
Pewter effect	166.11.900



Don't forget to order M4 handle screws, see page **353**  
For our full range of fixing materials and installation tools see the Installation & Display section, pages **350-353**

## Odessa

AT A GLANCE

KITCHEN APPLICATIONS

BEDROOM APPLICATIONS

BATHROOM APPLICATIONS

HANDLE FREE APPLICATIONS

INSTALLATION & DISPLAY

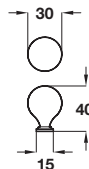
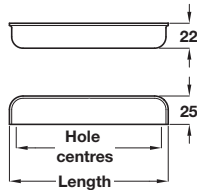

### ODESSA cup handle

- > Order M4 handle screws separately
- > Zinc alloy
- > Order qty: 1 pc



Finish	Length	Hole centres	Cat. No.
Polished chrome	78 mm	64 mm	<b>151.40.660</b>
	140 mm	128 mm	<b>151.40.665</b>
Stainless steel effect	78 mm	64 mm	<b>151.40.661</b>
	140 mm	128 mm	<b>151.40.666</b>
Brushed copper	78 mm	64 mm	<b>151.40.662</b>
	140 mm	128 mm	<b>151.40.667</b>



### ODESSA knob

- > Order M4 handle screws separately
- > Zinc alloy
- > Order qty: 1 pc



Finish	Cat. No.
Polished chrome	<b>110.35.360</b>
Stainless steel effect	<b>110.35.361</b>
Brushed copper	<b>110.35.362</b>



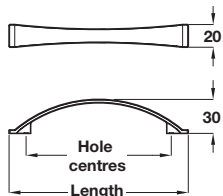

### ODESSA bow handle



- > Order M4 handle screws separately
- > Zinc alloy
- > Order qty: 1 pc



Finish	Length	Hole centres	Cat. No.
Polished chrome	158 mm	128 mm	<b>107.03.610</b>
Stainless steel effect			<b>107.03.611</b>
Brushed copper			<b>107.03.613</b>

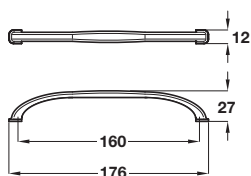

### ODESSA bow handle



- > Order M4 handle screws separately
- > Zinc alloy
- > Order qty: 1 pc



Finish	Cat. No.
Polished chrome	<b>107.03.615</b>
Stainless steel effect	<b>107.03.616</b>
Brushed copper	<b>107.03.617</b>



Don't forget to order M4 handle screws, see page **353**  
 For our full range of fixing materials and installation tools see the Installation & Display section, pages **350-353**

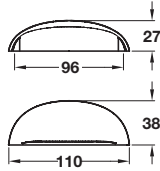

Note: ± 3 mm tolerance on non-critical dimensions and ±1 mm on hole centre dimensions

## RESTORATION cup handle



- > 2x M4 x 25 mm handle screws included
- > Brass
- > Order qty: 1 pc



Finish	Cat. No.
Polished chrome	151.00.200
Stainless steel effect	151.00.400

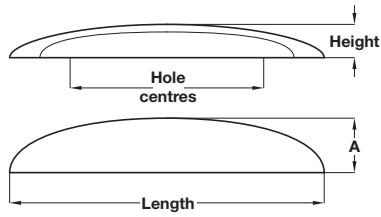

Product is subject to variations in colour and dimensions due to being manufactured from natural materials

## WILTON cup handle



- > Order M4 handle screws separately
- > Oak unfinished
- > Order qty: 1 pc



Finish	Length	Hole centres	Height	Dim. A	Cat. No.
Oak unfinished	80 mm	32 mm	20 mm	40 mm	192.52.421
	210 mm	160 mm	22 mm	36.5 mm	192.52.425



Don't forget to order M4 handle screws, see page **353**  
For our full range of fixing materials and installation tools see the Installation & Display section, pages **350-353**

# Mayberry



Aspekt cabinet doors from Häfele - York matt dove grey and midnight blue featured with Mayberry cup handles and knobs in polished chrome finish

+ View the full Aspekt cabinet doors range, visit [www.hafele.co.uk/aspekt-doors](http://www.hafele.co.uk/aspekt-doors)

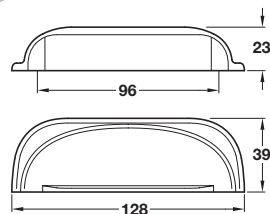

### MAYBERRY cup handle

- > Order M4 handle screws separately
- > Zinc alloy
- > Order qty: 1 pc



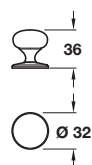

Finish	Cat. No.
 Polished nickel	<b>151.40.650</b>



### MAYBERRY knob

- > 1x M4 x 25 mm and 1x M4 x 45 mm snap off handle screws included
- > \*Order M4 handle screws separately
- > Zinc alloy
- > Order qty: 1 pc



Finish	Cat. No.
 Polished nickel	<b>123.02.130*</b>
 Polished black nickel	<b>123.02.330</b>

+ The HENRIETTA cup handle shown on page 128 matches the MAYBERRY knob

## Augusta

AT A GLANCE

KITCHEN APPLICATIONS

BEDROOM APPLICATIONS

BATHROOM APPLICATIONS

HANDLE FREE APPLICATIONS



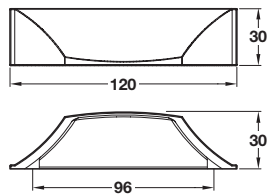

INSTALLATION & DISPLAY



### AUGUSTA cup handle

- > Order M4 handle screws separately
- > Zinc alloy
- > Order qty: 1 pc



Finish	Cat. No.
 Stainless steel effect	<b>118.68.104</b>
 Polished nickel	<b>118.68.704</b>
 Polished chrome	<b>118.68.204</b>
 Matt black	<b>118.68.804</b>
 Antique copper	<b>118.68.004</b>



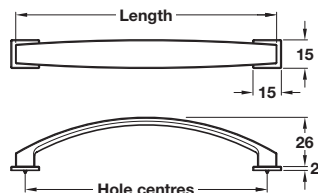

### AUGUSTA bow handle with backplates



- > Order M4 handle screws separately
- > Use with or without backplates
- > Zinc alloy
- > Order qty: 1 set



Finish	Length	Hole centres	Cat. No.
Stainless steel effect	138 mm	128 mm	<b>103.30.105</b>
	170 mm	160 mm	<b>103.30.106</b>
Polished nickel	138 mm	128 mm	<b>103.30.705</b>
	170 mm	160 mm	<b>103.30.706</b>
Polished chrome	138 mm	128 mm	<b>103.30.205</b>
	170 mm	160 mm	<b>103.30.206</b>
Matt black	138 mm	128 mm	<b>103.30.805</b>
	170 mm	160 mm	<b>103.30.806</b>
Antique copper	138 mm	128 mm	<b>103.30.005</b>
	170 mm	160 mm	<b>103.30.006</b>



### AUGUSTA knob with backplate



- > Order M4 handle screws separately
- > Use with or without backplate
- > Zinc alloy
- > Order qty: 1 set



Finish	15 x 15 mm	30 x 30 mm
Stainless steel effect	<b>110.35.380</b>	<b>110.35.392</b>
Polished nickel	<b>110.35.381</b>	-
Polished chrome	<b>110.35.382</b>	<b>110.35.390</b>
Matt black	<b>110.35.384</b>	<b>110.35.393</b>
Antique copper	<b>110.35.383</b>	<b>110.35.394</b>



Don't forget to order M4 handle screws, see page **353**  
 For our full range of fixing materials and installation tools see the Installation & Display section, pages **350-353**

## Smooth

AT A GLANCE

KITCHEN APPLICATIONS

BEDROOM APPLICATIONS

BATHROOM APPLICATIONS

HANDLE FREE APPLICATIONS

INSTALLATION & DISPLAY

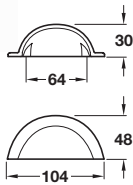

### SMOOTH cup handle

- > 2x M4 x 25 mm handle screws and 2x M4 x 45 mm snap off screws included
- > Cast iron
- > Order qty: 1 pc



Finish	Cat. No.
 Natural iron	120.67.951

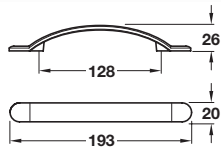

### SMOOTH bow handle

- > 2x M4 x 25 mm handle screws and 2x M4 x 45 mm snap off screws included
- > Cast iron
- > Order qty: 1 pc



Finish	Cat. No.
 Natural iron	120.67.963

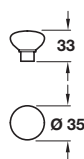

### SMOOTH knob

- > 1x M4 handle screw included
- > Cast iron
- > Order qty: 1 pc



Finish	Cat. No.
 Natural iron	120.67.961

# Beaulieu

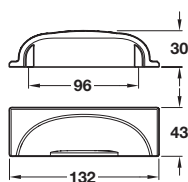

Note: ± 3 mm tolerance on non-critical dimensions and ±1 mm on hole centre dimensions  
Product is subject to variations in finish due to the finishing and manufacturing process of certain materials

## BEAULIEU cup handle

- > 2x M4 x 25 mm handle screws included
- > Cast iron
- > Order qty: 1 pc



Finish	Cat. No.
Natural iron	<b>151.00.935</b>

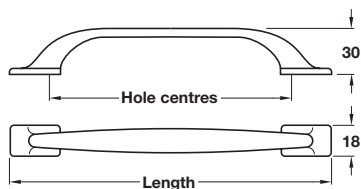

Note: ± 3 mm tolerance on non-critical dimensions and ±1 mm on hole centre dimensions  
Product is subject to variations in finish due to the finishing and manufacturing process of certain materials

## BEAULIEU D handle

- > 2x M4 x 25 mm handle screws included
- > Cast iron
- > Order qty: 1 pc



Finish	Length	Hole centres	Cat. No.
Natural iron	169 mm	128 mm	<b>119.29.055</b>
	233 mm	192 mm	<b>119.29.057</b>

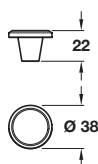

Note: ± 3 mm tolerance on non-critical dimensions  
Product is subject to variations in finish due to the finishing and manufacturing process of certain materials

## BEAULIEU knob

- > 1x M4 x 25 mm handle screw included
- > Cast iron
- > Order qty: 1 pc



Finish	Cat. No.
Natural iron	<b>119.25.961</b>

FURNITURE HANDLES 2021, © Häfele U.K. Ltd 2021. Dimensional data not binding. We reserve the right to alter specifications without notice.

## Bold

AT A GLANCE

KITCHEN APPLICATIONS

BEDROOM APPLICATIONS

BATHROOM APPLICATIONS

HANDLE FREE APPLICATIONS

INSTALLATION & DISPLAY

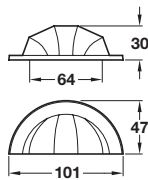

Note: ± 3 mm tolerance on non-critical dimensions and ±1 mm on hole centre dimensions  
Product is subject to variations in finish due to the finishing and manufacturing process of certain materials

### BOLD cup handle

- > 2x M4 x 25 mm handle screws included
- > Cast iron
- > Order qty: 1 pc



Finish	Cat. No.
 Natural iron	<b>123.02.020</b>

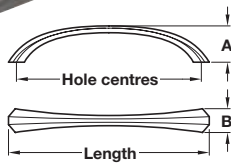

Note: ± 3 mm tolerance on non-critical dimensions and ±1 mm on hole centre dimensions  
Product is subject to variations in finish due to the finishing and manufacturing process of certain materials

### BOLD bow handle

- > 2x M4 x 25 mm handle screws included
- > Cast iron
- > Order qty: 1 pc



Finish	Length	Hole centres	Dim. A	Dim. B	Cat. No.
 Natural iron	141 mm	128 mm	28 mm	18 mm	<b>123.02.002</b>
	177 mm	160 mm	35 mm	21 mm	<b>123.02.003</b>

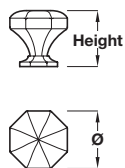

Note: ± 3 mm tolerance on non-critical dimensions  
Product is subject to variations in finish due to the finishing and manufacturing process of certain materials

### BOLD knob

- > 1x M4 x 25 mm handle screw included
- > Cast iron
- > Order qty: 1 pc



Finish	Diameter	Height	Cat. No.
 Natural iron	Ø 38 mm	37 mm	<b>123.02.060</b>

# Kane

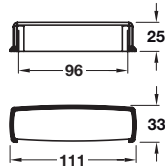

Product is subject to variations in finish due to the finishing and manufacturing process of certain materials

## KANE cup handle

- > 2x 8/32 x 1" (non-metric) screws included
- > Zinc alloy
- > Order qty: 1 pc



Finish	Cat. No.
 Oil rubbed bronze	133.50.140

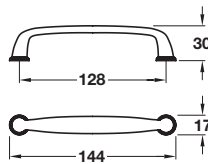

Product is subject to variations in finish due to the finishing and manufacturing process of certain materials

## KANE pull handle

- > 2x 8/32 x 1" (non-metric) screws included
- > Zinc alloy
- > Order qty: 1 pc



Finish	Cat. No.
 Oil rubbed bronze	133.50.340

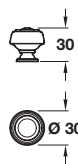

Product is subject to variations in finish due to the finishing and manufacturing process of certain materials

## KANE knob

- > 1x 8/32 x 1" (non-metric) screw included
- > Zinc alloy
- > Order qty: 1 pc



Finish	Cat. No.
 Oil rubbed bronze	133.50.609



All handles on this page include 8/32 x 1" (non-metric) screws. If you require a different length order non-metric cut off screw Cat. No. 022.24.881 shown on page 353

Delia

AT A GLANCE

KITCHEN APPLICATIONS

BEDROOM APPLICATIONS

BATHROOM APPLICATIONS

HANDLE FREE APPLICATIONS

INSTALLATION & DISPLAY

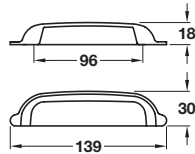

\*Product is subject to variations in finish due to the finishing and manufacturing process of certain materials

**DELIA cup handle**

- > Order M4 handle screws separately
- > Brass
- > Order qty: 1 pc



Finish	Cat. No.
 Brushed brass*	<b>110.35.115</b>
 Polished nickel	<b>110.35.116</b>
 Antique copper*	<b>110.35.117</b>

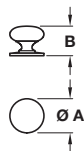



\*Product is subject to variations in finish due to the finishing and manufacturing process of certain materials

**DELIA knob**

- > Order M4 handle screw separately
- > Brass
- > Order qty: 1 pc



Finish	Dim. A	Dim. B	Cat. No.
 Brushed brass*	Ø 30 mm	26 mm	<b>110.35.110</b>
	Ø 35 mm	28 mm	<b>110.35.105</b>
 Polished nickel	Ø 30 mm	26 mm	<b>110.35.111</b>
	Ø 35 mm	28 mm	<b>110.35.106</b>
 Antique copper*	Ø 30 mm	26 mm	<b>110.35.112</b>
	Ø 35 mm	28 mm	<b>110.35.107</b>

FURNITURE HANDLES 2021, © Häfele U.K. Ltd 2021. Dimensional data not binding. We reserve the right to alter specifications without notice.

# Jude

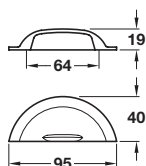

\*Product is subject to variations in finish due to the finishing and manufacturing process of certain materials

## JUDE cup handle

- > Order M4 handle screws separately
- > Brass
- > Order qty: 1 pc



Finish	Cat. No.
 Brushed brass*	110.35.120
 Polished nickel	110.35.121
 Antique copper*	110.35.122

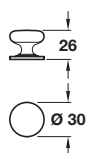



\*Product is subject to variations in finish due to the finishing and manufacturing process of certain materials

## JUDE knob

- > Order M4 handle screw separately
- > Brass
- > Order qty: 1 pc



Finish	Cat. No.
 Brushed brass*	110.35.100
 Polished nickel	110.35.101
 Antique copper*	110.35.102

## Lamont

AT A GLANCE

KITCHEN APPLICATIONS



BEDROOM APPLICATIONS

BATHROOM APPLICATIONS

HANDLE FREE APPLICATIONS

INSTALLATION & DISPLAY

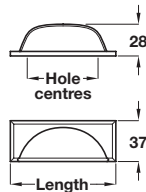

Note:  $\pm 3$  mm tolerance on non-critical dimensions and  $\pm 1$  mm on hole centre dimensions  
Product is subject to variations in finish due to the finishing and manufacturing process of certain materials

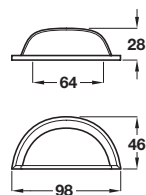

Note:  $\pm 3$  mm tolerance on non-critical dimensions and  $\pm 1$  mm on hole centre dimensions  
Product is subject to variations in finish due to the finishing and manufacturing process of certain materials

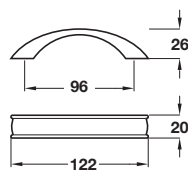

Note:  $\pm 3$  mm tolerance on non-critical dimensions and  $\pm 1$  mm on hole centre dimensions  
Product is subject to variations in finish due to the finishing and manufacturing process of certain materials

### LAMONT cup handle

- > 2x M4 x 45 mm snap off screws included
- > Pewter
- > Order qty: 1 pc



Finish	Length	Hole centres	Cat. No.
Pewter	96 mm	64 mm	<b>166.04.910</b>
	167 mm	128 mm	<b>166.04.912</b>
	201 mm	160 mm	<b>166.04.913</b>



### LAMONT cup handle

- > 2x M4 x 45 mm snap off screws include
- > Pewter
- > Order qty: 1 pc



Finish	Length	Hole centres	Cat. No.
Pewter	98 mm	64 mm	<b>166.04.920</b>



### LAMONT bow handle

- > 2x M4 x 45 mm handle screws included
- > Pewter
- > Order qty: 1 pc



Finish	Length	Hole centres	Cat. No.
Pewter	122 mm	96 mm	<b>120.89.931</b>





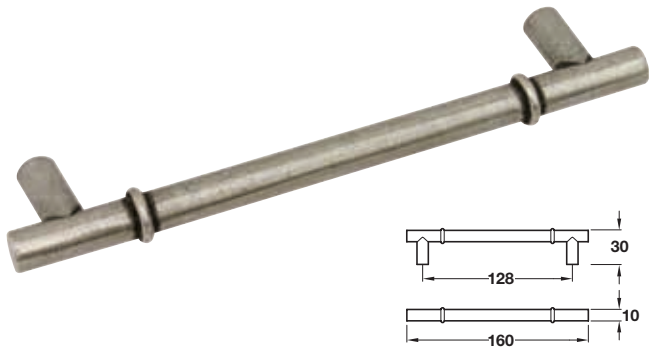

Note: ± 3 mm tolerance on non-critical dimensions and ±1 mm on hole centre dimensions  
Product is subject to variations in finish due to the finishing and manufacturing process of certain materials

**LAMONT bar handle, 1 ring design**

- > 2x M4 x 25 mm handle screws included
- > Pewter
- > Order qty: 1 pc



Finish	Length	Hole centres	Cat. No.
Pewter	160 mm	128 mm	<b>120.89.912</b>

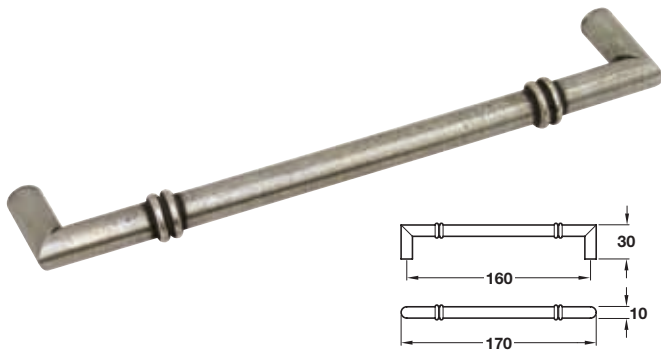

Note: ± 3 mm tolerance on non-critical dimensions and ±1 mm on hole centre dimensions  
Product is subject to variations in finish due to the finishing and manufacturing process of certain materials

**LAMONT D handle, 2 ring design**

- > 2x M4 x 25 mm handle screws included
- > Pewter
- > Order qty: 1 pc



Finish	Length	Hole centres	Cat. No.
Pewter	170 mm	160 mm	<b>120.89.913</b>

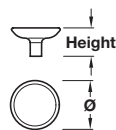

Note: ± 3 mm tolerance on non-critical dimensions and ±1 mm on hole centre dimensions  
Product is subject to variations in finish due to the finishing and manufacturing process of certain materials

**LAMONT knob**

- > 1x M4 x 45 mm handle screw included
- > Pewter
- > Order qty: 1 pc



Finish	Length	Hole centres	Cat. No.
Pewter	Ø 33 mm	20 mm	<b>135.43.931</b>
	Ø 43 mm	25 mm	<b>135.43.932</b>

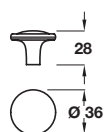

Note: ± 3 mm tolerance on non-critical dimensions and ±1 mm on hole centre dimensions  
Product is subject to variations in finish due to the finishing and manufacturing process of certain materials

**LAMONT knob**

- > 1x M4 x 45 mm snap off screw included
- > Pewter
- > Order qty: 1 pc



Finish	Diameter	Height	Cat. No.
Pewter	Ø 36 mm	28 mm	<b>135.43.960</b>



# Mulberry

AT A GLANCE

KITCHEN APPLICATIONS

BEDROOM APPLICATIONS

BATHROOM APPLICATIONS

HANDLE FREE APPLICATIONS

INSTALLATION & DISPLAY

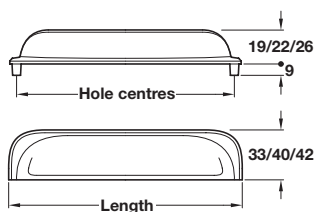

Note: ± 3 mm tolerance on non-critical dimensions and ±1 mm on hole centre dimensions

## MULBERRY cup handle

- > Order M4 handle screws separately
- > \*2x M4 x 25 mm handle screws included
- > Brass
- > Order qty: 1 pc



Finish	Length	Hole centres	Cat. No.
Polished nickel	77 mm	64 mm	<b>151.40.203*</b>
	108 mm	96 mm	<b>151.40.204*</b>
	204 mm	192 mm	<b>151.40.207*</b>
Polished chrome	108 mm	96 mm	<b>151.40.254</b>
Brushed copper	108 mm	96 mm	<b>151.40.154</b>



Don't forget to order M4 handle screws, see page **353**  
 For our full range of fixing materials and installation tools see the Installation & Display section, pages **350-353**

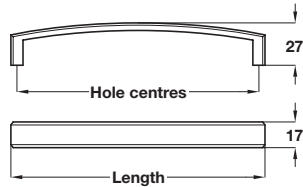

Note: ± 3 mm tolerance on non-critical dimensions and ±1 mm on hole centre dimensions

### MULBERRY D handle

- > 2x M4 x 25 mm handle screws included
- > Brass
- > Order qty: 1 pc



Finish	Length	Hole centres	Cat. No.
Polished nickel	135 mm	128 mm	<b>116.35.255</b>
	168 mm	160 mm	<b>116.35.256</b>

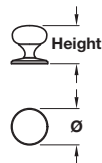

Note: ± 3 mm tolerance on non-critical dimensions

### MULBERRY knob

- > Order M4 handle screws separately
- > \*1x M4 x 25 mm handle screw included
- > Brass
- > Order qty: 1 pc



Finish	Diameter	Height	Cat. No.
Polished nickel	Ø 32 mm	36 mm	<b>123.02.700*</b>
	Ø 38 mm	42 mm	<b>123.02.710*</b>
Polished chrome	Ø 38 mm	42 mm	<b>134.97.220</b>
Brushed copper	Ø 38 mm	42 mm	<b>134.97.020</b>

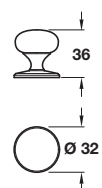

Note: ± 3 mm tolerance on non-critical dimensions and ±1 mm on hole centre dimensions

### MULBERRY knob

- > 1x M4 x 25 mm handle screw included
- > Brass
- > Order qty: 1 pc



Finish	Cat. No.
Polished chrome	<b>135.07.230</b>
Stainless steel effect	<b>135.07.600</b>

## Ironbridge

AT A GLANCE

KITCHEN APPLICATIONS

BEDROOM APPLICATIONS

BATHROOM APPLICATIONS

HANDLE FREE APPLICATIONS

INSTALLATION & DISPLAY

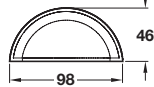
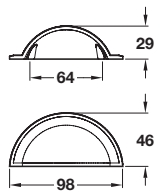

Note: ± 3 mm tolerance on non-critical dimensions and ±1 mm on hole centre dimensions

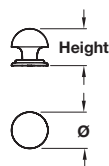

Note: ± 3 mm tolerance on non-critical dimensions and ±1 mm on hole centre dimensions

### IRONBRIDGE cup handle

- > 2x M4 x 25 mm handle screws included
- > Brass
- > Order qty: 1 pc



Finish	Cat. No.
 Polished nickel	<b>151.00.700</b>



### IRONBRIDGE knob

- > 1x M4 x 30 mm handle screw included
- > Brass
- > Order qty: 1 pc



Finish	Diameter	Height	Cat. No.
 Polished nickel	Ø 32 mm	34 mm	<b>135.07.700</b>
	Ø 38 mm	37 mm	<b>135.07.710</b>



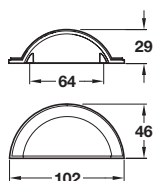



Note: ± 3 mm tolerance on non-critical dimensions and ±1 mm on hole centre dimensions  
Product is subject to variations in finish due to the finishing and manufacturing process of certain materials

## IRONBRIDGE cup handle



- > 2x M4 x 25 mm and 2x M4 x 45 mm snap off screws included
- > \*2x M4 x 25 mm and 2x M4 x 30 mm handle screws included
- > Cast iron
- > Order qty: 1 pc



Finish	Cat. No.
 Natural iron	151.00.924
 Aged brass effect	151.00.124*

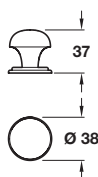



Note: ± 3 mm tolerance on non-critical dimensions and ±1 mm on hole centre dimensions  
Product is subject to variations in finish due to the finishing and manufacturing process of certain materials

## IRONBRIDGE knob



- > 1x M4 x 25 mm and 1x M4 x 45 mm handle screws included
- > \*1x M4 x 30 mm handle screw included
- > Cast iron
- > Order qty: 1 pc



Finish	Cat. No.
 Natural iron	119.25.950
 Aged brass effect	119.25.150*



**+** The CONWY pull handle shown on page 148 matches the IRONBRIDGE cup handle and knob

## Conwy

AT A GLANCE

KITCHEN APPLICATIONS

BEDROOM APPLICATIONS

BATHROOM APPLICATIONS

HANDLE FREE APPLICATIONS

INSTALLATION & DISPLAY

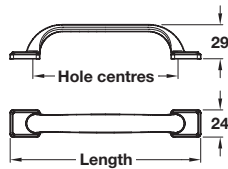

Note: ± 3 mm tolerance on non-critical dimensions and ±1 mm on hole centre dimensions  
Product is subject to variations in finish due to the finishing and manufacturing process of certain materials

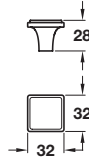

Note: ± 3 mm tolerance on non-critical dimensions and ±1 mm on hole centre dimensions  
Product is subject to variations in finish due to the finishing and manufacturing process of certain materials



The IRONBRIDGE cup handle and knob shown on page 147 matches the CONWY pull handle

### CONWY pull handle



- > 2x M4 x 25 mm handle screws included
- > Base material
- > Order qty: 1 pc



Finish	Length	Hole centres	Cat. No.
Natural iron	168 mm	128 mm	121.75.945
	199 mm	160 mm	121.75.956
Aged brass effect	168 mm	128 mm	121.75.145

### CONWY knob



- > 1x M4 x 25 mm handle screw included
- > Cast iron
- > Order qty: 1 pc



Finish	Cat. No.
Natural iron	119.25.940

# ASPEKT KITCHEN CABINET DOORS FROM HÄFELE



Hampstead Ultragloss Aqua Blue

Introducing our NEW collection of kitchen cabinet doors. Manufactured in the UK and with the FIRA Gold quality seal of approval, these doors come with a Häfele lifetime guarantee\*.

Our range of door sizes make an easy job of designing kitchens, including built-in appliances. Visit [www.hafele.co.uk/aspekt-doors](http://www.hafele.co.uk/aspekt-doors) to see the full range.

Key features include:

- > 18 colours and finishes
- > FIRA Gold approved
- > Free 48 hour delivery\*
- > No minimum order quantity

\*Ts & Cs apply



Skye Matt Midnight Blue



York Matt Slate Grey



Stirling Gloss Dove Grey

Visit [hafele.co.uk/aspekt-doors](http://hafele.co.uk/aspekt-doors) to view the full range

## Queslett

AT A GLANCE

KITCHEN APPLICATIONS

BEDROOM APPLICATIONS

BATHROOM APPLICATIONS

HANDLE FREE APPLICATIONS

INSTALLATION & DISPLAY

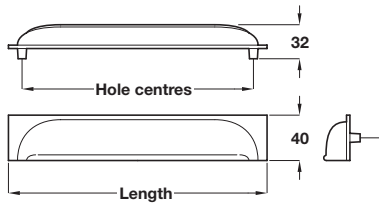

Note: ± 3 mm tolerance on non-critical dimensions and ±1 mm on hole centre dimensions

### QUESLETT cup handle

- > 2x M4 x 50 mm snap off handle screws included
- > Brass
- > Order qty: 1 pc



Finish	Length	Hole centres	Cat. No.
Polished nickel	64 mm	40 mm	<b>166.08.710</b>
	108 mm	96 mm	<b>166.08.711</b>
	228 mm	202 mm	<b>166.08.714</b>

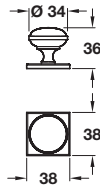

Note: ± 3 mm tolerance on non-critical dimensions

### QUESLETT knob

- > 1x M4 x 50 mm snap off handle screw included
- > Brass
- > Order qty: 1 pc



Finish	Cat. No.
Polished nickel	<b>137.80.700</b>



# Land



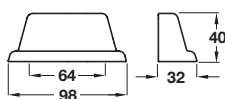

Aspekt cabinet doors from Häfele - Skye gloss ice white featured with Land cup pull handles and knobs in matt black finish



### LAND cup pull handle

- > 2x M4 x 25 mm handle screw included
- > Zinc alloy
- > Order qty: 1 pc





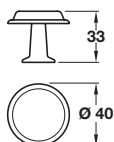

Finish	Cat. No.
 Brushed gold	106.60.311
 Pewter	106.60.312
 Antique brass	106.60.313
 Matt black	106.60.314



### LAND knob

- > 1x M4 x 25 mm handle screw included
- > Zinc alloy
- > Order qty: 1 pc



Finish	Cat. No.
 Brushed gold	106.60.308
 Pewter	106.60.309
 Antique brass	106.60.310
 Matt black	106.60.321

 View the full Aspekt cabinet doors range, visit [www.hafele.co.uk/aspekt-doors](http://www.hafele.co.uk/aspekt-doors)

# Crawford

AT A GLANCE

KITCHEN APPLICATIONS

BEDROOM APPLICATIONS

BATHROOM APPLICATIONS

HANDLE FREE APPLICATIONS

INSTALLATION & DISPLAY



FURNITURE HANDLES 2021, © Häfele U.K. Ltd 2021. Dimensional data not binding. We reserve the right to alter specifications without notice.

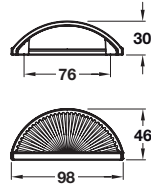

\*Product is subject to variations in finish due to the finishing and manufacturing process of certain materials

### CRAWFORD cup handle

- > 2x 8/32 x 1" (non-metric) screws included
- > Zinc alloy
- > Order qty: 1 pc



Finish	Cat. No.
Golden champagne	133.50.143
Oil rubbed bronze*	133.50.144

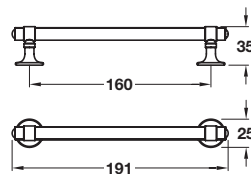

\*Product is subject to variations in finish due to the finishing and manufacturing process of certain materials

### CRAWFORD pull handle

- > 2x 8/32 x 1" (non-metric) screws included
- > Zinc alloy
- > Order qty: 1 pc



Finish	Cat. No.
Golden champagne	133.50.374
Oil rubbed bronze*	133.50.377

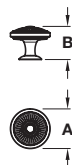

\*Product is subject to variations in finish due to the finishing and manufacturing process of certain materials

### CRAWFORD knob

- > 1x 8/32 x 1" (non-metric) screw included
- > Zinc alloy
- > Order qty: 1 pc



Finish	Dim. A	Dim. B	Cat. No.
Golden champagne	Ø 35 mm	30 mm	133.50.303
Oil rubbed bronze*	Ø 35 mm	30 mm	133.50.305



All handles on this page include 8/32 x 1" (non-metric) screws. If you require a different length order non-metric cut off screw Cat. No. 022.24.881 shown on page 353

## Cotswold

AT A GLANCE

KITCHEN APPLICATIONS

BEDROOM APPLICATIONS

BATHROOM APPLICATIONS

HANDLE FREE APPLICATIONS

INSTALLATION & DISPLAY

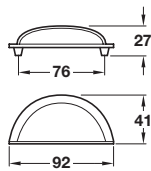

Note: ± 3 mm tolerance on non-critical dimensions and ±1 mm on hole centre dimensions  
Product is subject to variations in finish due to the finishing and manufacturing process of certain materials

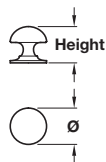

Note: ± 3 mm tolerance on non-critical dimensions and ±1 mm on hole centre dimensions  
Product is subject to variations in finish due to the finishing and manufacturing process of certain materials

### COTSWOLD cup handle

- > 2x M4 x 50 mm handle screws included
- > Brass
- > Order qty: 1 pc



Finish	Cat. No.
Polished nickel	151.07.701
Brushed copper	151.07.001

### COTSWOLD knob

- > 1x M4 x 50 mm handle screw included
- > Brass
- > Order qty: 1 pc



Finish	Diameter	Height	Cat. No.
Polished nickel	Ø 31 mm	32 mm	134.97.710
	Ø 38 mm	39 mm	134.97.711
Brushed copper	Ø 38 mm	39 mm	134.97.011



Brushed copper has not been lacquered and will change naturally over time



**COTSWOLD cup handle**

- > 3x Ø 3.5 x 20 mm raised head screws included
- > Brass
- > Order qty: 1 pc

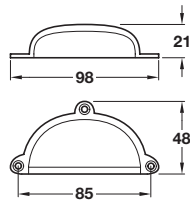

Note: ± 3 mm tolerance on non-critical dimensions and ±1 mm on hole centre dimensions

\*Product is subject to variations in finish due to the finishing and manufacturing process of certain materials

Finish	Cat. No.
Polished nickel	<b>166.08.700</b>
Bronzed and brushed*	<b>166.08.100</b>
Polished brass	<b>166.08.800</b>



**COTSWOLD knob**

- > 1x M4 x 50 mm snap off handle screw included
- > Brass
- > Order qty: 1 pc

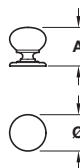

Note: ± 3 mm tolerance on non-critical dimensions

\*Product is subject to variations in finish due to the finishing and manufacturing process of certain materials

Finish	Diameter	Dim. A	Cat. No.
Polished nickel	Ø 31 mm	33 mm	<b>133.32.710</b>
	Ø 38 mm	36 mm	<b>133.32.711</b>
Bronzed and brushed*	Ø 33 mm	33 mm	<b>133.32.100</b>
Polished brass	Ø 33 mm	33 mm	<b>133.32.800</b>



**COTSWOLD drop handle**

- > 2x M4 spindle and nut included
- > Brass
- > Order qty: 1 pc

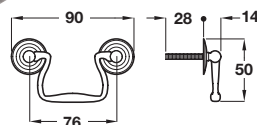

Note: ± 3 mm tolerance on non-critical dimensions and ±1 mm on hole centre dimensions

Product is subject to variations in finish due to the finishing and manufacturing process of certain materials

Finish	Cat. No.
Bronzed and brushed	<b>120.13.130</b>



Bronzed and brushed has not been lacquered and will change naturally over time



### EGG TIMER knob

- > 1x M4 x 30 mm handle screw and 2x washers included
- > Aluminium
- > Order qty: 1 pc

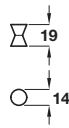

Finish	Cat. No.
 Polished nickel	<b>133.99.601</b>



### BINX knob

- > Order M4 handle screws separately
- > Steel
- > Order qty: 1 pc

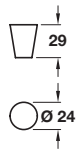



Finish	Cat. No.
 Stainless steel effect	<b>135.47.600</b>

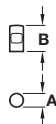

### LEO knob

- > Order M4 handle screws separately
- > Zinc alloy
- > Order qty: 1 pc





Finish	Dim A	Dim B	Cat. No.
 Stainless steel effect	Ø 12 mm	23 mm	<b>135.63.601</b>
	Ø 20 mm	25 mm	<b>135.63.602</b>

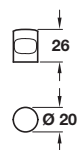

### ORSON knob

- > Order M4 handle screws separately
- > Aluminium
- > Order qty: 1 pc



Finish	Cat. No.
 Anodised aluminium	<b>133.49.900</b>



### BEUVRON T knob

- > Order M4 handle screws separately
- > Zinc alloy
- > Order qty: 1 pc

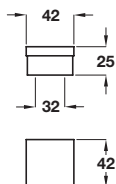

Finish	Cat. No.
Stainless steel effect	108.55.000
Polished chrome	108.55.200



### CORMOR pull handle

- > Order M4 handle screws separately
- > Zinc alloy
- > Order qty: 1 pc

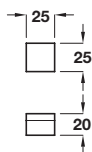

Finish	Cat. No.
Stainless steel effect	131.17.000



### DEXTER pull handle

- > Order M4 handle screws separately
- > Zinc alloy
- > Order qty: 1 pc

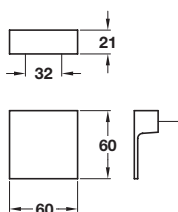

Finish	Cat. No.
Polished chrome	102.68.220
Stainless steel effect	102.68.020



Don't forget to order M4 handle screws, see page **353**

For our full range of fixing materials and installation tools see the Installation & Display section, pages **350-353**

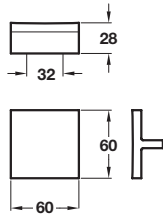

### AMBER knob

- > Order M4 handle screws separately
- > Zinc alloy
- > Order qty: 1 pc



Finish	Cat. No.
 Polished chrome	131.14.260

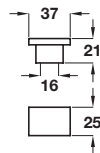

### LARA knob

- > Order 2x M4 handle screws separately
- > Zinc alloy
- > Order qty: 1 pc



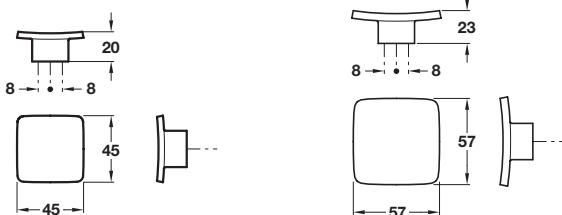

Finish	Cat. No.
 Polished chrome	131.17.200



### FLYNN knob

- > Order 2x M4 handle screws separately
- > Zinc alloy
- > Order qty: 1 pc



Finish	45 x 45 mm	57 x 57 mm
 Stainless steel effect	131.27.001	131.11.000
 Polished chrome	131.27.201	131.11.200





### OVAL knob

- > Order M4 handle screws separately
- > Zinc alloy
- > Order qty: 1 pc

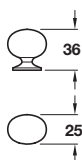





Finish	Cat. No.
 Stainless steel effect	131.26.000

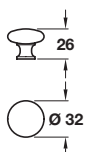

### ORIEL knob

- > Order M4 handle screws separately
- > Zinc alloy
- > Order qty: 1 pc





Finish	Cat. No.
 Matt nickel	134.02.600
 Stainless steel effect	135.24.600
 Polished chrome	133.09.200

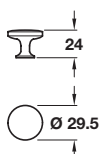

### CASSIUS knob

- > Order M4 handle screws separately
- > Zinc alloy
- > Order qty: 1 pc



Finish	Cat. No.
 Stainless steel effect	137.35.600



Don't forget to order M4 handle screws, see page **353**

For our full range of fixing materials and installation tools see the Installation & Display section, pages **350-353**

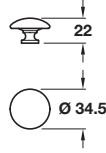

### AMELIA knob

- > 1x M4 x 25 mm handle screw included
- > \*Order M4 handle screws separately
- > Zinc alloy
- > Order qty: 1 pc



Finish	Cat. No.
Matt nickel	<b>135.00.600</b>
Stainless steel effect	<b>133.10.600*</b>
Polished chrome	<b>133.10.200*</b>

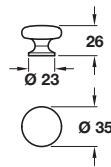

### ASPEN knob

- > Order M4 handle screws separately
- > Zinc alloy
- > Order qty: 1 pc



Finish	Cat. No.
Stainless steel effect	<b>134.61.620</b>

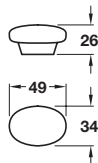

### BIANCA knob

- > Order M4 handle screws separately
- > Zinc alloy
- > Order qty: 1 pc



Finish	Cat. No.
Stainless steel effect	<b>133.96.602</b>



Don't forget to order M4 handle screws, see page **353**  
For our full range of fixing materials and installation tools see the Installation & Display section, pages **350-353**

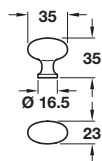

### CLEO knob

- > Order M4 handle screws separately
- > Zinc alloy
- > Order qty: 1 pc



Finish	Cat. No.
 Stainless steel effect	134.63.620

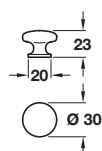

### COCO knob

- > Order M4 handle screws separately
- > Zinc alloy
- > Order qty: 1 pc



Finish	Cat. No.
 Stainless steel effect	134.61.610

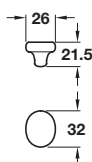

### FLOYD knob

- > Order M4 handle screws separately
- > Zinc alloy
- > Order qty: 1 pc



Finish	Cat. No.
 Stainless steel effect	134.62.610

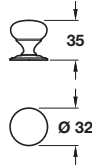

Note: ± 3 mm tolerance on non-critical dimensions

### RUGBY knob

- > 1x M4 x 25 mm handle screw included
- > \*1x M4 x 30 mm handle screw included
- > Brass
- > Order qty: 1 pc



Finish	Cat. No.
Polished nickel	134.97.701
Stainless steel effect	134.97.001*

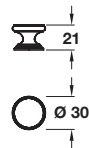

### CLAYTON knob

- > Order M4 handle screws separately
- > Brass
- > Order qty: 1 pc



Finish	Cat. No.
Polished brass	137.71.803
Polished chrome	137.71.205

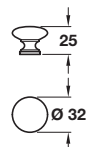

### CORRINE knob

- > Order M4 handle screws separately
- > Brass
- > Order qty: 1 pc



Finish	Cat. No.
Polished chrome	137.72.202
Polished brass	137.72.800





Don't forget to order M4 handle screws, see page **353**  
For our full range of fixing materials and installation tools see the Installation & Display section, pages **350-353**

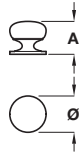

**GROSVENOR knob**

- > Order M4 handle screws separately
- > Brass
- > Order qty: 1 pc



Finish	Diameter	Dim. A	Cat. No.
 Polished chrome	Ø 32 mm	28 mm	<b>137.00.224</b>
	Ø 38 mm	30 mm	<b>137.00.205</b>
 Polished brass	Ø 32 mm	28 mm	<b>137.00.822</b>
	Ø 38 mm	30 mm	<b>137.00.805</b>

## BESPOKE TIMBER DRAWERS

Kitchen drawers are becoming an increasingly popular alternative to traditional cabinets. Our drawer range includes many different sizes and finishes, including a handcrafted, bespoke-sized timber option.



Walnut



Ply

Our Bespoke Timber Drawers are handmade in the UK from high grade solid timber. There are a number of design and personalisation choices available including a choice of wood types and come complete with dove-tailed joints.

The Häfele to Order service takes the manufacture, finishing, packaging and delivery off your hands, saving you time and money.



Oak

Find out more at [www.hafele.co.uk/bespoke-timber-drawers](http://www.hafele.co.uk/bespoke-timber-drawers)

## Rocher, Balley & Sula

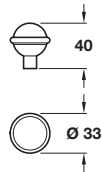

Note: ± 3 mm tolerance on non-critical dimensions

### ROCHER knob

- > 1x M4 x 25 mm handle screw included
- > Brass
- > Order qty: 1 pc



Finish	Cat. No.
 Polished nickel	<b>137.80.730</b>

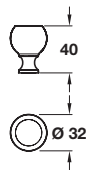

Note: ± 3 mm tolerance on non-critical dimensions

### BALLEY knob

- > 1x M4 x 25 mm handle screw included
- > Brass
- > Order qty: 1 pc



Finish	Cat. No.
 Polished nickel	<b>135.07.720</b>

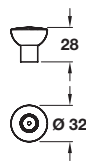

Note: ± 3 mm tolerance on non-critical dimensions

### SULA knob

- > 1x M4 x 25 mm handle screw included
- > Brass
- > Order qty: 1 pc



Finish	Cat. No.
 Polished nickel	<b>135.07.730</b>





Rocher knob Cat. No. 137.80.730 shown on round backplate Cat. No. 137.80.740

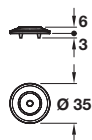

Note: ± 3 mm tolerance on non-critical dimensions

### Round backplate

- > Order M4 handle screw separately
- > Brass
- > Order qty: 1 pc



Finish	Cat. No.
 Polished nickel	137.80.740

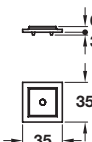

Note: ± 3 mm tolerance on non-critical dimensions

### Square backplate

- > Order M4 handle screw separately
- > Brass
- > Order qty: 1 pc



Finish	Cat. No.
 Polished nickel	137.80.750

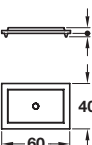

Note: ± 3 mm tolerance on non-critical dimensions

### Rectangular backplate

- > Order M4 handle screw separately
- > Brass
- > Order qty: 1 pc



Finish	Cat. No.
 Polished nickel	137.80.760

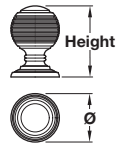

Note: ± 3 mm tolerance on non-critical dimensions and ±1 mm on hole centre dimensions

### JUPITER knob

- > 1x M4 x 25 mm handle screw included
- > Brass
- > Order qty: 1 pc



Finish	Diameter	Height	Cat. No.
Stainless steel effect	Ø 32 mm	44 mm	<b>123.02.080</b>
	Ø 38 mm	52 mm	<b>135.07.610</b>

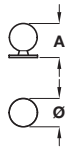

### KENDRICK knob

- > Order M4 handle screws separately
- > Brass
- > Order qty: 1 pc



Finish	Diameter	Dim. A	Cat. No.
Polished chrome	Ø 25 mm	30 mm	<b>137.02.228</b>
	Ø 30 mm	34 mm	<b>137.02.237</b>



Don't forget to order M4 handle screws, see page **353**  
For our full range of fixing materials and installation tools see the Installation & Display section, pages **350-353**





### VICTORIA knob

- > Order M4 handle screws separately
- > Ceramic
- > Order qty: 1 pc

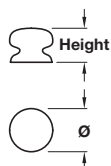

Finish	Diameter	Dim. A	Cat. No.
White	Ø 38 mm	30 mm	<b>130.48.701</b>
Magnolia	Ø 38 mm	30 mm	<b>130.48.407</b>
Black	Ø 38 mm	30 mm	<b>130.48.309</b>
	Ø 50 mm	39 mm	<b>130.48.302</b>

AT A GLANCE

KITCHEN APPLICATIONS

BEDROOM APPLICATIONS

BATHROOM APPLICATIONS

HANDLE FREE APPLICATIONS

INSTALLATION & DISPLAY



### CALVIN knob

- > Order M4 handle screws separately
- > Porcelain
- > Order qty: 1 pc

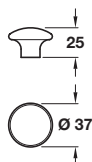

Finish	Cat. No.
White	<b>130.19.710</b>



### IRIS knob

- > Order M4 handle screws separately
- > Ceramic
- > Order qty: 1 pc

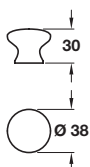

Finish	Cat. No.
White	<b>130.17.700</b>

## Timber Grain Knobs

Timber knobs are available in two versions, routed cross grain and turned end grain. Routed knobs have the cross grain on top, like you have on a wooden front. Turned knobs have the end grain on top of the knob



### Cross grain knobs -

Individually routed from a fixed wooden block with a full shaped tool. Each knob is then sanded to the final shape. This method of manufacture makes for a higher quality knob that shows the natural wood grain to it's best

### End grain knobs -

Traditional turned knobs are turned on a copy lathe from a long turning wood dowel and cut off automatically. This method of manufacture is faster and produces a more economical and cost effective product



Oak, unfinished



Oak, antique oak stained and lacquered





Product is subject to variations in colour and dimensions due to being manufactured from natural materials

### Knob, cross grain

- > Order M4 handle screws separately
- > Wood, unfinished or stained and lacquered
- > Order qty: 1 pc



Finish	Diameter	Dim. A	Cat. No.
 Oak, unfinished	Ø 44 mm	40 mm	<b>195.63.400</b>
 Oak, antique oak stained and lacquered			<b>195.63.410</b>



Oak, unfinished



Beech, unfinished





Product is subject to variations in colour and dimensions due to being manufactured from natural materials

### Turned knob, end grain

- > Order M4 handle screws separately
- > Wood, unfinished
- > Order qty: 1 pc



Finish	Diameter	Dim. A	Cat. No.
 Oak	Ø 34 mm	28 mm	<b>195.75.401</b>
	Ø 44 mm	38 mm	<b>195.75.403</b>
 Beech	Ø 34 mm	28 mm	<b>195.75.301</b>
	Ø 44 mm	38 mm	<b>195.75.302</b>

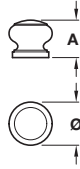

Product is subject to variations in colour and dimensions due to being manufactured from natural materials

### Turned knob, end grain

- > Order M4 handle screws separately
- > Wood, unfinished
- > Order qty: 1 pc



Finish	Diameter	Dim. A	Cat. No.
Oak	Ø 44 mm	38.5 mm	<b>195.76.403</b>
	Ø 38 mm	33 mm	<b>195.76.402</b>

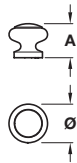

Product is subject to variations in colour and dimensions due to being manufactured from natural materials

### Turned knob, end grain

- > Order M4 handle screws separately
- > Wood, laquered
- > Order qty: 1 pc



Finish	Diameter	Dim. A	Cat. No.
Oak, clear lacquered	Ø 34 mm	30 mm	<b>195.68.400</b>



Oak, unfinished



Oak, light oak stained and lacquered



Product is subject to variations in colour and dimensions due to being manufactured from natural materials

### Turned knob, end grain

- > Order M4 handle screws separately
- > Wood unfinished or stained and lacquered
- > Order qty: 1 pc



Finish	Diameter	Dim. A	Cat. No.
Oak, unfinished	Ø 39 mm	28 mm	<b>195.78.401</b>
	Ø 44 mm	30 mm	<b>195.78.402</b>
Oak, light oak stained and lacquered	Ø 44 mm	40 mm	<b>195.55.400</b>



Don't forget to order M4 handle screws, see page **353**  
For our full range of fixing materials and installation tools see the Installation & Display section, pages **350-353**



Oak, unfinished



Maple, unfinished



Beech, unfinished



Pine, unfinished

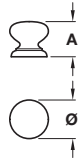

Product is subject to variations in colour and dimensions due to being manufactured from natural materials

### Turned knob, end grain

- > Order M4 handle screws separately
- > Wood, unfinished
- > Order qty: 1 pc



Finish	Diameter	Dim. A	Cat. No.
Oak	Ø 34 mm	31 mm	<b>195.77.401</b>
	Ø 44 mm	39 mm	<b>195.77.402</b>
	Ø 49 mm	40 mm	<b>195.77.403</b>
Maple	Ø 44 mm	39 mm	<b>195.77.102</b>
Beech	Ø 34 mm	31 mm	<b>195.77.301</b>
	Ø 44 mm	39 mm	<b>195.77.302</b>
Pine	Ø 34 mm	31 mm	<b>195.77.001</b>



Oak, unfinished



Oak, antique oak stained and lacquered

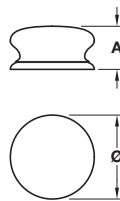

Product is subject to variations in colour and dimensions due to being manufactured from natural materials

### Victorian knob, cross grain

- > Order M4 handle screws separately
- > Wood, unfinished or stained and lacquered
- > Order qty: 1 pc



Finish	Diameter	Dim. A	Cat. No.
Oak, unfinished	Ø 50 mm	37 mm	<b>196.83.410</b>
	Ø 54 mm	39 mm	<b>195.64.400</b>
Oak, antique oak stained and lacquered	Ø 54 mm	39 mm	<b>195.64.410</b>



Product is subject to variations in colour and dimensions due to being manufactured from natural materials

### Shaker knob, cross grain

- > Order M4 handle screws separately
- > Wood unfinished
- > Order qty: 1 pc



Finish	Diameter	Dim. A	Cat. No.
Beech	Ø 45 mm	29 mm	<b>195.60.300</b>

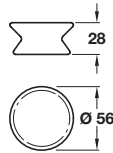

Product is subject to variations in colour and dimensions due to being manufactured from natural materials

### YOYO knob

- > 1x M4 x 28 mm handle screws included
- > \*Order M4 handles screws separately
- > \*\*Made from FSC® certified wood
- > Oak or walnut
- > Order qty: 1 pc



Finish	Cat. No.
Oak lacquered	195.79.430*
Smoked oak	195.79.421**
Walnut	195.79.740*

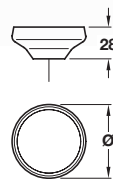

Product is subject to variations in colour and dimensions due to being manufactured from natural materials

### CADOGAN knob

- > Order M4 handle screws separately
- > \*Made from FSC® certified wood
- > Wood unfinished or lacquered
- > Order qty: 1 pc



Finish	Ø 42 mm	Ø 67 mm
Oak unfinished	-	195.79.410
Oak lacquered	195.79.423*	195.79.413*

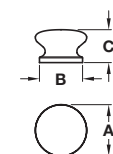

Product is subject to variations in colour and dimensions due to being manufactured from natural materials

### SHAKER knob

- > 1x M4 x 30 mm handle screw included
- > Oak
- > Order qty: 1 pc



Finish	Dim. A	Dim. B	Dim. C	Cat. No.
Smoked oak	Ø 45 mm	Ø 38 mm	29 mm	195.60.410
	Ø 55 mm	Ø 48 mm	29 mm	195.62.410

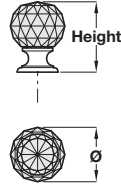

### HARLEY knob

- > 1x M4 x 22 mm and 1x M4 x 25 mm handle screws included
- > Glass knob with brass base
- > Order qty: 1 pc



Finish	Length	Height	Cat. No.
	Ø 30 mm	41 mm	<b>139.60.422</b>
	Ø 35 mm	45 mm	<b>139.60.423</b>

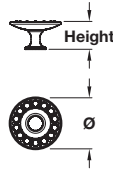

### DIAMOND knob

- > Order M4 handle screws separately
- > Zinc alloy with Swarovski crystal
- > Order qty: 1 pc



Finish	Length	Height	Cat. No.
	Ø 45 mm	27 mm	<b>132.19.270</b>

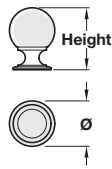

### PRIMROSE knob

- > Order M4 handle screws separately
- > Zinc alloy with glass knob
- > Order qty: 1 pc



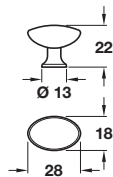

Finish	Length	Height	Cat. No.
	Ø 25 mm	36 mm	<b>139.60.400</b>
	Ø 30 mm	41 mm	<b>139.60.401</b>



### PEARL knob

- > Order M4 handle screws separately
- > Zinc alloy
- > Order qty: 1 pc



Finish	Cat. No.
	<b>133.09.210</b>
	<b>133.09.410</b>
	<b>133.09.010</b>



# Como



Aspekt cabinet doors from Häfele - Hampstead ultragloss aqua blue featured with Este pull handles and Como knobs in matt black finish

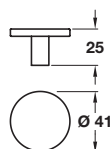

### COMO knob

- > 1x M4 x 25 mm handle screw included
- > Zinc alloy
- > Order qty: 1 pc



Finish	Cat. No.
 Matt black	106.66.287
 Brushed nickel	106.66.285
 Brushed gold	106.66.284
 Brushed copper	106.66.286



➔ The ESTE pull handle shown on page 91 matches the COMO knob

⊕ View the full Aspekt cabinet doors range, visit [www.hafele.co.uk/aspekt-doors](http://www.hafele.co.uk/aspekt-doors)

FURNITURE HANDLES 2021, © Häfele U.K. Ltd 2021. Dimensional data not binding. We reserve the right to alter specifications without notice.

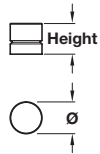

### ACER knob

- > 1x M4 x 25 mm handle screw included
- > Stainless steel
- > Order qty: 1 pc



Finish	Diameter	Height	Cat. No.
Stainless steel	Ø 18 mm	23 mm	<b>134.88.611</b>
	Ø 28 mm	27 mm	<b>134.88.610</b>

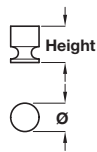

### CYRUS knob

- > Order M4 handle screws separately
- > Brass
- > Order qty: 1 pc



Finish	Diameter	Height	Cat. No.
Polished chrome	Ø 16 mm	20 mm	<b>137.03.216</b>
	Ø 19 mm	24 mm	<b>137.03.225</b>
	Ø 25 mm	32 mm	<b>137.03.234</b>

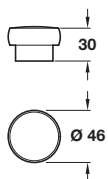

### ACACIA knob

- > Order M4 handle screws separately
- > Zinc alloy
- > Order qty: 1 pc



Finish	Cat. No.
Stainless steel effect	<b>131.15.000</b>





### CHLOEU knob

- > Order M4 handle screws separately
- > Brass
- > Order qty: 1 pc

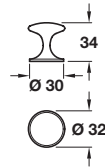

\*Product is subject to variations in finish due to the finishing and manufacturing process of certain materials

Finish	Cat. No.
Brushed brass*	123.03.500
Polished nickel	123.03.700



### KEW knob

- > 1x M4 x 25 mm handle screw included
- > Brass
- > Order qty: 1 pc

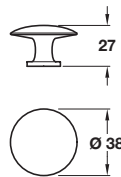

Note: ± 3 mm tolerance on non-critical dimensions

Finish	Cat. No.
Polished chrome	134.97.482
Stainless steel effect	134.97.083



### CONSTANCE knob

- > Order M4 handle screws separately
- > Zinc alloy
- > Order qty: 1 pc

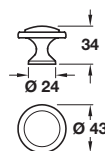

Finish	Cat. No.
Polished chrome	134.45.220
Stainless steel effect	134.45.620



Don't forget to order M4 handle screws, see page **353**  
For our full range of fixing materials and installation tools see the Installation & Display section, pages **350-353**

## Oberon

AT A GLANCE

KITCHEN APPLICATIONS

BEDROOM APPLICATIONS

BATHROOM APPLICATIONS

HANDLE FREE APPLICATIONS

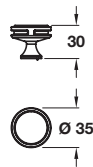

INSTALLATION & DISPLAY



### OBERON knob

- > 1x 8/32 x 1" (non-metric) screw included
- > Zinc alloy
- > Order qty: 1 pc



Finish	Cat. No.
 Golden champagne	<b>133.50.618</b>
 Polished nickel	<b>133.50.622</b>





All handles on this page include 8/32 x 1" (non-metric) screws. If you require a different length order non-metric cut off screw Cat. No. 022.24.881 shown on page **353**

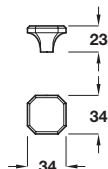

**CORBUSIER knob**

- > 1x M4 handle screw included
- > Zinc alloy
- > Order qty: 1 pc



Finish	Cat. No.
 Polished chrome	<b>123.08.260</b>

**Luca**



**LUCA pull handle**

- > Order M4 handle screws separately
- > Zinc alloy
- > Order qty: 1 pc

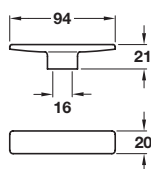



Finish	Cat. No.
 Polished chrome	<b>100.63.200</b>

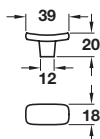

**LUCA knob**

- > Order M4 handle screws separately
- > Brass
- > Order qty: 1 pc



Finish	Cat. No.
 Polished chrome	<b>131.25.201</b>



Don't forget to order M4 handle screws, see page **353**  
For our full range of fixing materials and installation tools see the Installation & Display section, pages **350-353**

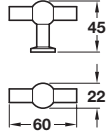

### GEMINI pull handle

- > Order M4 handle screws separately
- > Zinc alloy
- > Order qty: 1 pc



Finish	Cat. No.
 Stainless steel effect	137.55.600

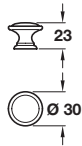

### ANGUS knob

- > Order M4 handle screws separately
- > Zinc alloy
- > Order qty: 1 pc



Finish	Cat. No.
 Polished chrome	118.06.214
 Matt nickel	118.06.616
 Antique brass	118.06.116



Don't forget to order M4 handle screws, see page **353**  
For our full range of fixing materials and installation tools see the Installation & Display section, pages **350-353**

# ASPEKT KITCHEN CABINET DOORS FROM HÄFELE



Hampstead Ultragloss Aqua Blue

Introducing our NEW collection of kitchen cabinet doors. Manufactured in the UK and with the FIRA Gold quality seal of approval, these doors come with a Häfele lifetime guarantee\*.

Our range of door sizes make an easy job of designing kitchens, including built-in appliances. Visit [www.hafele.co.uk/aspekt-doors](http://www.hafele.co.uk/aspekt-doors) to see the full range.

Key features include:

- > 18 colours and finishes
- > FIRA Gold approved
- > Free 48 hour delivery\*
- > No minimum order quantity

\*Ts & Cs apply



Skye Matt Midnight Blue



York Matt Slate Grey



Stirling Gloss Dove Grey

Visit [hafele.co.uk/aspekt-doors](http://hafele.co.uk/aspekt-doors) to view the full range

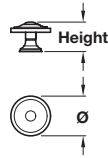

### ALBANO knob

- > Order M4 handle screws separately
- > Zinc alloy
- > Order qty: 1 pc



Finish	Diameter	Height	Cat. No.
Antique brass	Ø 30 mm	23 mm	<b>134.33.111</b>

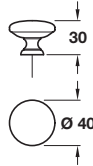

### CARTON knob

- > Order M4 handle screws separately
- > Brass
- > Order qty: 1 pc



Finish	Cat. No.
Antique brass	<b>122.49.110</b>

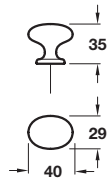

### CHESTER knob

- > Order M4 handle screws separately
- > Zinc alloy
- > Order qty: 1 pc



Finish	Cat. No.
Antique brass	<b>120.70.160</b>



### HELENE knob

- > 1x M4 x 50 mm snap off handle screw included
- > Brass
- > Order qty: 1 pc



Finish	Cat. No.
Bronzed and brushed	<b>133.31.100</b>

Note: ± 3 mm tolerance on non-critical dimensions

Product is subject to variations in finish due to the finishing and manufacturing process of certain materials



Bronzed and brushed has not been lacquered and will change naturally over time

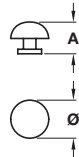

Due to the manufacturing processes of certain materials this product is subject to variations in dimensions  
Product is subject to variations in finish due to the finishing and manufacturing process of certain materials

### POLKA knob



- > 1x M4 x 45 mm handle screw included
- > Cast iron
- > Order qty: 1 pc



Finish	Diameter	Dim. A	Cat. No.
Natural iron	Ø 32 mm	29 mm	<b>120.48.901</b>

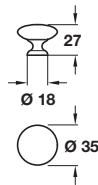

### SORRENTO knob



- > Order M4 handle screws separately
- > Zinc alloy
- > Order qty: 1 pc



Finish	Cat. No.
Antique pewter	<b>133.97.913</b>

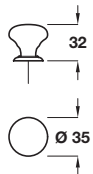

Note: ± 3 mm tolerance on non-critical dimensions

Product is subject to variations in finish due to the finishing and manufacturing process of certain materials

### TAMAR knob



- > 1x M4 x 25 mm handle screw included
- > Cast iron
- > Order qty: 1 pc



Finish	Cat. No.
Natural iron	<b>121.75.920</b>

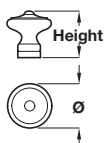

Note: ± 3 mm tolerance on non-critical dimensions

Product is subject to variations in finish due to the finishing and manufacturing process of certain materials

### TAURION knob

- > Order M4 handle screws separately
- > Cast iron
- > Order qty: 1 pc



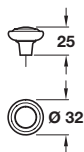

Finish	Diameter	Height	Cat. No.
Natural iron	Ø 30 mm	30 mm	<b>119.25.902</b>
	Ø 40 mm	40 mm	<b>119.25.903</b>



### EDEN knob

- > Order M4 handle screws separately
- > Zinc alloy
- > Order qty: 1 pc



Finish	Cat. No.
 Antique brass	134.27.186
 Antique pewter	134.27.980

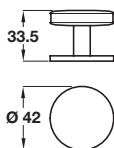

### BRUNSWICK knob

- > 1x M4 x 45 mm handle screw included
- > Pewter
- > Order qty: 1 pc



Finish	Cat. No.
 Pewter	135.43.940

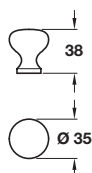

Note: ± 3 mm tolerance on non-critical dimensions and ±1 mm on hole centre dimensions  
Product is subject to variations in finish due to the finishing and manufacturing process of certain materials



### BUXTON knob, Ø 35 mm

- > 1x M4 x 25 mm handle screw included
- > Cast iron
- > Order qty: 1 pc



Finish	Cat. No.
 Natural iron	119.27.004
 Black	119.12.300

Note: ± 3 mm tolerance on non-critical dimensions  
Product is subject to variations in finish due to the finishing and manufacturing process of certain materials



Don't forget to order M4 handle screws, see page **353**  
For our full range of fixing materials and installation tools see the Installation & Display section, pages **350-353**



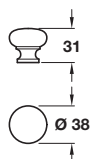

Note: ± 3 mm tolerance on non-critical dimensions

Product is subject to variations in finish due to the finishing and manufacturing process of certain materials

### SAVANNAH knob



- > 1x M4 x 25 mm handle screw included
- > Cast iron
- > Order qty: 1 pc



Finish	Cat. No.
 Natural iron	123.02.041

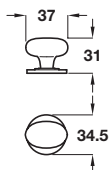

Note: ± 3 mm tolerance on non-critical dimensions

Product is subject to variations in finish due to the finishing and manufacturing process of certain materials

### SYON knob

- > 1x M4 x 25 mm handle screw included
- > Cast iron
- > Order qty: 1 pc



Finish	Cat. No.
 Antique pewter	119.64.941

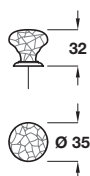

Note: ± 3 mm tolerance on non-critical dimensions



Product is subject to variations in finish due to the finishing and manufacturing process of certain materials

### ARCADIA knob



- > 1x M4 x 25 mm handle screw included
- > Cast iron and ceramic
- > Order qty: 1 pc



Finish	Cat. No.
 Antique silver / White crackled	121.75.930
 Antique brass / Bone	121.75.120

## Twister

AT A GLANCE

KITCHEN APPLICATIONS

BEDROOM APPLICATIONS

BATHROOM APPLICATIONS

HANDLE FREE APPLICATIONS

INSTALLATION & DISPLAY



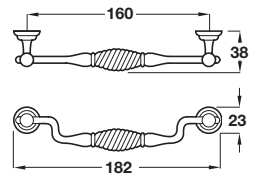

### TWISTER drop handle

- > 2x M4 x 26 mm handle screw included
- > Zinc alloy
- > Order qty: 1 pc



Finish	Cat. No.
 Antique pewter	119.20.921

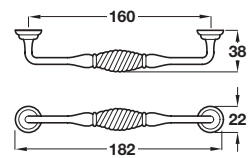

### TWISTER D handle

- > 2x M4 x 26 mm handle screw included
- > Zinc alloy
- > Order qty: 1 pc



Finish	Cat. No.
 Antique pewter	119.20.910

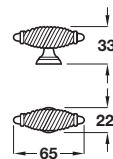

### TWISTER pull handle

- > 1x M4 x 26 mm handle screw included
- > Zinc alloy
- > Order qty: 1 pc



Finish	Cat. No.
 Antique pewter	119.20.900

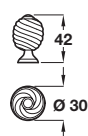

### TWISTER knob

- > 1x M4 x 26 mm handle screw included
- > Zinc alloy
- > Order qty: 1 pc



Finish	Cat. No.
 Antique pewter	119.21.900

## Caxton

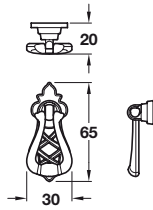

### CAXTON drop handle

- > Order M4 handle screws separately
- > Zinc alloy
- > Order qty: 1 pc



Finish	Cat. No.
 Bronzed and brushed	122.37.100

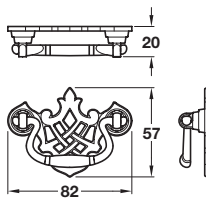

### CAXTON drop bar handle

- > Order M4 handle screws separately
- > Zinc alloy
- > Order qty: 1 pc



Finish	Cat. No.
 Bronzed and brushed	122.38.100

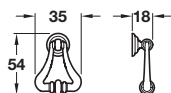

### ARGENTON drop pendant handle

- > 1 M4 x 26 mm fixing screw included
- > Zinc alloy
- > Order qty: 1 pc



Finish	Cat. No.
 Antique brass	118.32.107

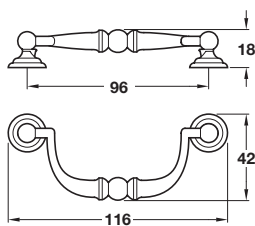

### RISLE drop handle

- > Order M4 handle screws separately
- > Zinc alloy
- > Order qty: 1 pc



Finish	Cat. No.
 Antique brass	118.10.101



Don't forget to order M4 handle screws, see page **353**  
For our full range of fixing materials and installation tools see the Installation & Display section, pages **350-353**

## Curve

AT A GLANCE

KITCHEN APPLICATIONS

BEDROOM APPLICATIONS

BATHROOM APPLICATIONS

HANDLE FREE APPLICATIONS

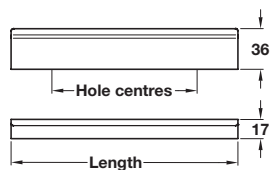
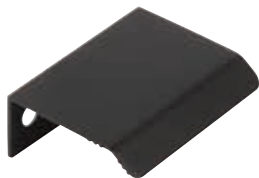

INSTALLATION & DISPLAY



### CURVE profile handle

- > 2x M4 x 25 mm handle screws included
- > Aluminium
- > Order qty: 1 pc



Finish	Length	Hole centres	Cat. No.
 Stainless steel effect	45 mm	32 mm	<b>126.45.031</b>
	100 mm	64 mm	<b>126.45.032</b>
	200 mm	128 mm	<b>126.45.035</b>
	300 mm	192 mm	<b>126.45.037</b>
	400 mm	320 mm	<b>126.45.038</b>
 Matt white	500 mm	416 mm	<b>126.45.039</b>
	45 mm	32 mm	<b>126.45.751</b>
 Matt black	200 mm	128 mm	<b>126.45.755</b>
	45 mm	32 mm	<b>126.45.351</b>
	200 mm	128 mm	<b>126.45.355</b>

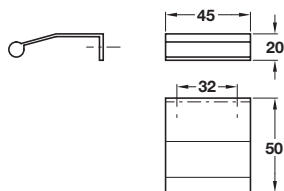

### MADDOX pull handle

- > Order M4 handle screws separately
- > Zinc alloy
- > Order qty: 1 pc



Finish	Cat. No.
Polished chrome	124.40.240
Matt chrome	124.40.440

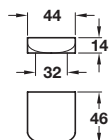
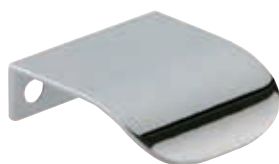

### ELLA pull handle

- > Order M4 handle screws separately
- > Zinc alloy
- > Order qty: 1 pc



Finish	Cat. No.
Polished chrome	124.41.202
Matt chrome	124.41.402
Matt nickel	124.41.602

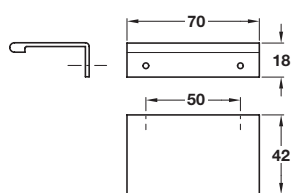
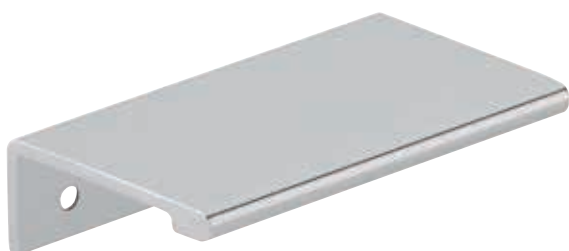

### QUINN pull handle

- > Order M4 handle screws separately
- > Aluminium
- > Order qty: 1 pc



Finish	Cat. No.
Polished chrome	124.02.220



Don't forget to order M4 handle screws, see page **353**

For our full range of fixing materials and installation tools see the Installation & Display section, pages **350-353**

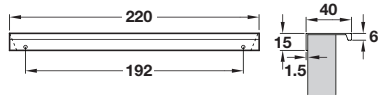

### FINN trim handle

- > 2x Ø 3.5 x 14 mm countersunk head screws included
- > Aluminium
- > Order qty: 1 pc



Finish	Cat. No.
 Stainless steel effect	<b>112.84.014</b>

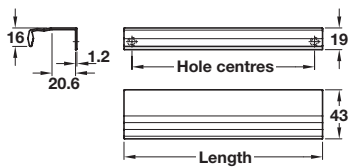
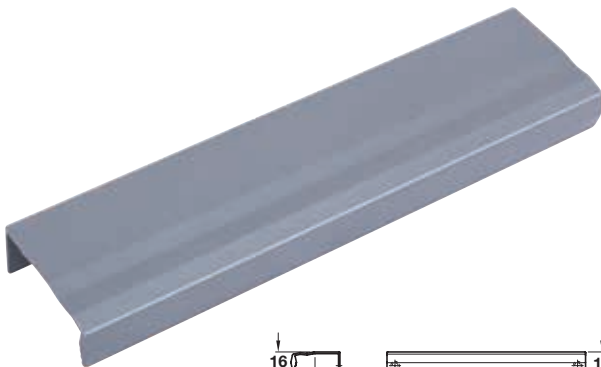

### LINE profile handle

- > Order M4 handle screws separately
- > Aluminium
- > Order qty: 1 pc



Finish	Length	Hole centres	Cat. No.
 Matt anthracite	78 mm	64 mm	<b>111.71.510</b>
	174 mm	160 mm	<b>111.71.511</b>
	334 mm	320 mm	<b>111.71.512</b>

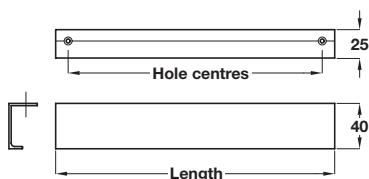

### LISTER trim handle

- > Order screws separately
- > Aluminium
- > Order qty: 1 pc



Finish	Length	Hole centres	Cat. No.
 Brushed nickel	147 mm	128 mm	<b>126.17.641</b>
	297 mm	256 mm	<b>126.17.642</b>



# Ona



AT A GLANCE

KITCHEN APPLICATIONS

BEDROOM APPLICATIONS

BATHROOM APPLICATIONS

HANDLE FREE APPLICATIONS

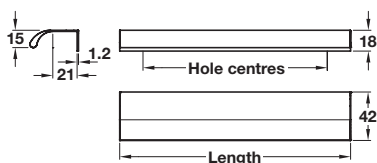

INSTALLATION & DISPLAY



## ONA profile handle

- > 2x M4 x 25 mm handle screws included
- > Aluminium
- > Order qty: 1 pc



Finish	Length	Hole centres	Cat. No.
 Brushed grey	50 mm	32 mm	<b>126.45.110</b>
	200 mm	128 mm	<b>126.45.111</b>
	350 mm	256 mm	<b>126.45.112</b>
	1100 mm	1056 mm	<b>126.45.113</b>
 Brushed black	50 mm	32 mm	<b>126.45.120</b>
	200 mm	128 mm	<b>126.45.121</b>
	350 mm	256 mm	<b>126.45.122</b>
	1100 mm	1056 mm	<b>126.45.123</b>

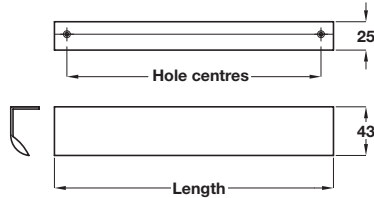

### CALAVON trim handle

- > Order screws separately
- > Aluminium
- > Order qty: 1 pc



Finish	Length	Hole centres	Cat. No.
Polished chrome	147 mm	128 mm	<b>126.17.221</b>
	297 mm	256 mm	<b>126.17.222</b>

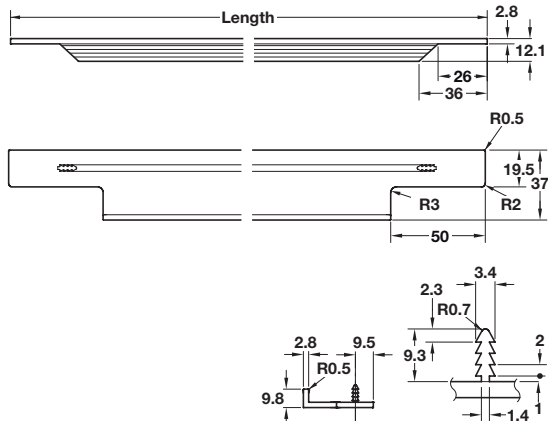

Note: ± 3 mm tolerance on non-critical dimensions

### PORTOBELLO profile handle

- > Groove mounted, suitable for 19 mm door thickness
- > Aluminium, stainless steel effect finish
- > Order qty: 1 pc



Finish	Length	Cat. No.
Stainless steel effect	147 mm	<b>126.45.010</b>
	197 mm	<b>126.45.011</b>
	247 mm	<b>126.45.012</b>
	297 mm	<b>126.45.013</b>
	347 mm	<b>126.45.014</b>
	397 mm	<b>126.45.015</b>
	447 mm	<b>126.45.016</b>
	497 mm	<b>126.45.017</b>
	597 mm	<b>126.45.018</b>
	697 mm	<b>126.45.019</b>
	797 mm	<b>126.45.020</b>
	897 mm	<b>126.45.021</b>
997 mm	<b>126.45.022</b>	
1197 mm	<b>126.45.023</b>	

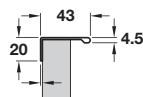

### SAANE profile grip, cabinet-wide handle

- > Aluminium silver
- > Order qty: 1 pc

Finish	Length	Cat. No.
Silver	2500 mm	<b>126.14.901</b>

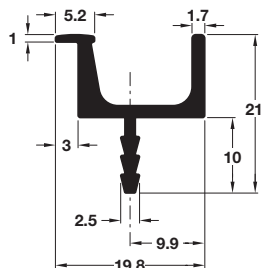
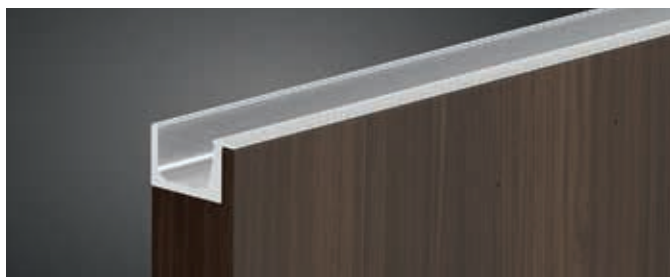

### LAMONE profile handle

- > Anodised aluminium
- > Order qty: 1 pc

Finish	Length	Groove length	Cat. No.
 Stainless steel effect	2500 mm	2450 mm	<b>126.95.000</b>

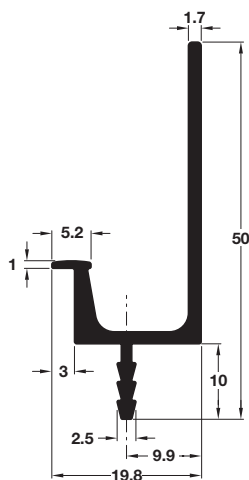

### ATTIS profile handle

- > Anodised aluminium
- > Order qty: 1 pc

Finish	Length	Groove length	Cat. No.
 Stainless steel effect	2500 mm	2450 mm	<b>126.95.010</b>

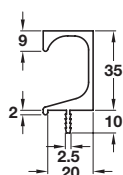

### CIRON profile handle

- > Anodised aluminium
- > Order qty: 1 pc

Finish	Length	Cat. No.
 Silver anodised aluminium	2500 mm	<b>155.01.150</b>

## Libra

AT A GLANCE

KITCHEN APPLICATIONS

BEDROOM APPLICATIONS

BATHROOM APPLICATIONS

HANDLE FREE APPLICATIONS

INSTALLATION & DISPLAY

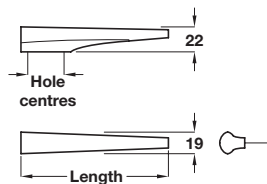

### LIBRA pull handle

- > 2x M4 x 25 mm handle screws included
- > Zinc alloy
- > Order qty: 1 pc



Finish	Length	Hole centres	Cat. No.
 Polished chrome	130 mm	32 mm	<b>107.03.200</b>
	210 mm	32/64 mm	<b>107.03.201</b>
	280 mm	64/96 mm	<b>107.03.202</b>



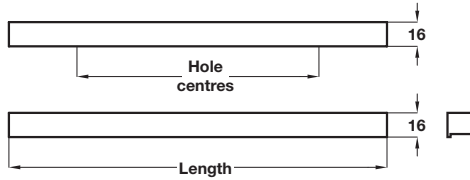

## AVELINE pull handle



- > 2x M4 x 25 mm handle screws included
- > Aluminium
- > Order qty: 1 pc



Finish	Length	Hole centres	Cat. No.
Polished chrome	80 mm	32 mm	<b>110.46.911</b>
	250 mm	160 mm	<b>110.46.916</b>
	350 mm	224 mm	<b>110.46.917</b>
	550 mm	480 mm	<b>110.46.918</b>



## ELVO pull handle



- > Order M4 handle screws separately
- > Zinc alloy
- > Order qty: 1 pc



Finish	Cat. No.
Polished chrome	<b>112.90.251</b>



Don't forget to order M4 handle screws, see page **353**

For our full range of fixing materials and installation tools see the Installation & Display section, pages **350-353**

## Angle

AT A GLANCE

KITCHEN APPLICATIONS

BEDROOM APPLICATIONS

BATHROOM APPLICATIONS

HANDLE FREE APPLICATIONS

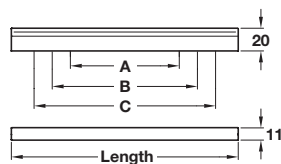

INSTALLATION & DISPLAY



### ANGLE pull handle

- > 2x M4 x 25 mm handle screws included
- > Aluminium
- > Order qty: 1 pc



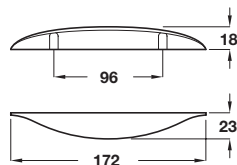
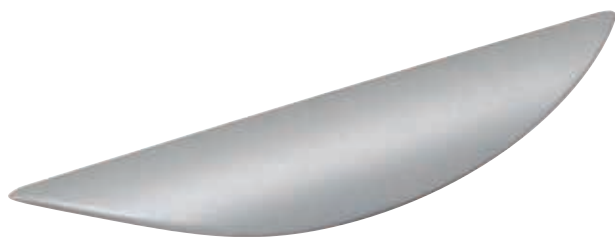

Finish	Length	Hole centres			Cat. No.
		A	B	C	
 Polished chrome	200 mm	96 mm	128 mm	160 mm	<b>108.66.230</b>
	400 mm	256 mm	320 mm	-	<b>108.66.231</b>
	500 mm	416 mm	320 mm	-	<b>108.66.232</b>
	900 mm	640 mm	-	-	<b>108.66.234</b>
 Matt black	200 mm	128 mm	160 mm	-	<b>108.66.330</b>
 Stainless steel effect	200 mm	96 mm	128 mm	160 mm	<b>108.66.030</b>



## AZALEA pull handle

- > Order M4 handle screws separately
- > Zinc alloy
- > Order qty: 1 pc



Finish	Cat. No.
 Matt nickel	106.33.602
 Silver RAL 9006	106.33.902

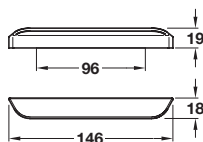

## OXFORD pull handle

- > 2x M4 x 25 mm handle screws and 2x M4 x 45 mm snap off handle screws included
- > Zinc alloy
- > Order qty: 1 pc



Finish	Cat. No.
 Polished chrome	102.18.224



Don't forget to order M4 handle screws, see page **353**  
For our full range of fixing materials and installation tools see the Installation & Display section, pages **350-353**

## Nick

AT A GLANCE

KITCHEN APPLICATIONS

BEDROOM APPLICATIONS

BATHROOM APPLICATIONS

HANDLE FREE APPLICATIONS

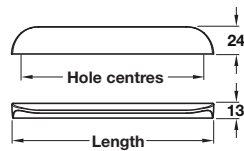

INSTALLATION & DISPLAY



### NICK pull handle

- > 2x M4 x 25 mm handle screws included
- > Aluminium
- > Order qty: 1 pc



Finish	Length	Hole centres	Cat. No.
 Brushed copper	50 mm	32 mm	<b>126.45.060</b>
	178 mm	160 mm	<b>126.45.061</b>
 Brushed brass	50 mm	32 mm	<b>126.45.062</b>
	178 mm	160 mm	<b>126.45.063</b>



# Noma



AT A GLANCE

KITCHEN APPLICATIONS

BEDROOM APPLICATIONS

BATHROOM APPLICATIONS

HANDLE FREE APPLICATIONS

INSTALLATION & DISPLAY

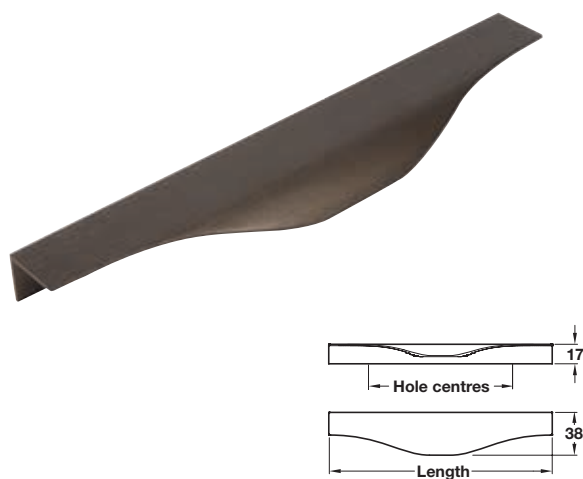

## NOMA profile handle

- > 2x M4 x 15 mm handle screws included
- > Aluminium
- > Order qty: 1 pc



Finish	Length	Hole centres	Cat. No.
Stainless steel effect	200 mm	128 mm	<b>126.45.045</b>
	350 mm	256 mm	<b>126.45.048</b>
Bright anodised	200 mm	128 mm	<b>126.45.965</b>
	350 mm	256 mm	<b>126.45.969</b>
Antique bronze	200 mm	128 mm	<b>126.45.046</b>
	350 mm	256 mm	<b>126.45.049</b>

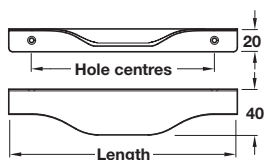

### PATIENCE profile handle

- > Order M4 handle screws separately
- > Aluminium
- > Order qty: 1 pc



Finish	Length	Hole centres	Cat. No.
Brushed copper	200 mm	160 mm	<b>126.17.230</b>
	300 mm	256 mm	<b>126.17.231</b>
	400 mm	320 mm	<b>126.17.232</b>



## BESPOKE TIMBER DRAWERS

Kitchen drawers are becoming an increasingly popular alternative to traditional cabinets. Our drawer range includes many different sizes and finishes, including a handcrafted, bespoke-sized timber option.



Walnut



Ply

Our Bespoke Timber Drawers are handmade in the UK from high grade solid timber. There are a number of design and personalisation choices available including a choice of wood types and come complete with dove-tailed joints.

The Häfele to Order service takes the manufacture, finishing, packaging and delivery off your hands, saving you time and money.



Oak

Find out more at [www.hafele.co.uk/bespoke-timber-drawers](http://www.hafele.co.uk/bespoke-timber-drawers)

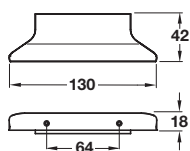
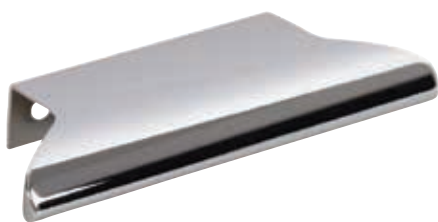

# Rita



## RITTA profile handle

- > 2x Ø3.5 x 15 mm countersunk screws included
- > Zinc alloy
- > Order qty: 1 pc



Finish	Cat. No.
 Polished chrome	<b>126.45.050</b>
 Stainless steel effect	<b>126.45.051</b>
 Matt black	<b>126.45.052</b>

## Cutt

AT A GLANCE

KITCHEN APPLICATIONS

BEDROOM APPLICATIONS

BATHROOM APPLICATIONS

HANDLE FREE APPLICATIONS

INSTALLATION & DISPLAY



Aspekt cabinet doors from Häfele - Hampstead ultragloss stone grey featured with Cutt pull handles in matt black finish

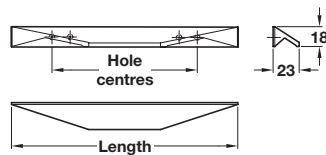

The CUTT pull handle can be positioned at the top of a drawer or placed in the middle

### CUTT pull handle

- > 2x M4 x 25 mm handle screws included
- > Aluminium
- > Order qty: 1 pc



Finish	Length	Hole centres	Cat. No.
● Matt black	200 mm	96/128 mm	<b>155.02.360</b>
	400 mm	192/320 mm	<b>155.02.361</b>
● Polished chrome	200 mm	96/128 mm	<b>106.60.316</b>
	400 mm	192/320 mm	<b>106.60.317</b>



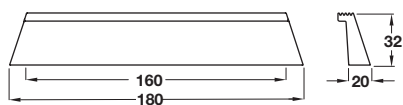
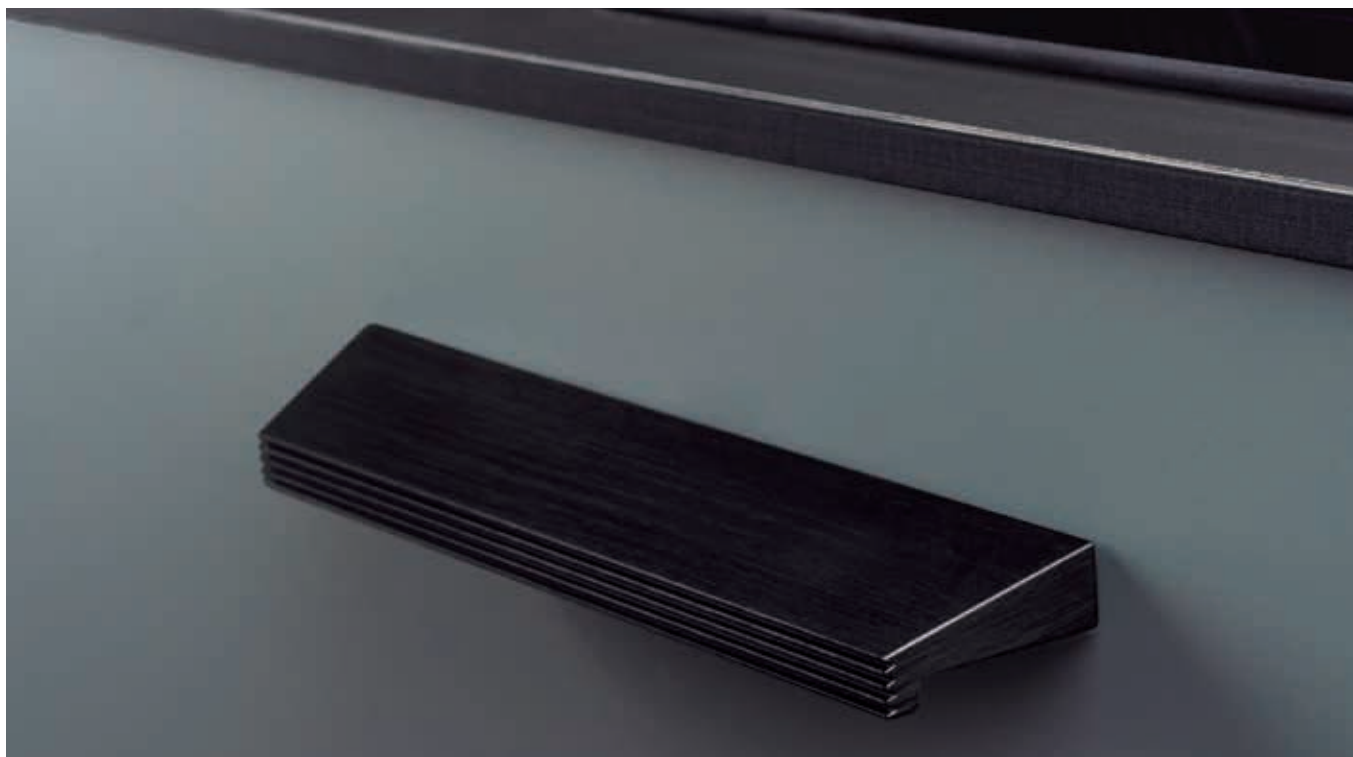

➕ View the full Aspekt cabinet doors range, visit [www.hafele.co.uk/aspect-doors](http://www.hafele.co.uk/aspect-doors)



**RAIL pull handle**

- > 2x M4 x 25 mm handle screw included
- > Aluminium
- > Order qty: 1 pc



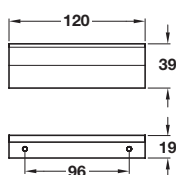

Finish	Cat. No.
 Brushed black	<b>106.60.319</b>
 Brushed brass	<b>106.60.320</b>



**RUBY trim handle**

- > 2x Ø 3.0 x 13 mm countersunk head screws included
- > Brass
- > Order qty: 1 pc



Finish	Cat. No.
 Brushed copper	<b>112.84.024</b>
 Polished nickel	<b>112.84.724</b>

Note: ± 3 mm tolerance on non-critical dimensions and ±1 mm on hole centre dimensions

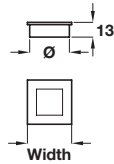

### SAUL inset handle

- > Press-fit
- > Zinc alloy
- > Order qty: 1 pc

Finish	Width	Diameter	Cat. No.
Polished chrome	39 mm	Ø 35 mm	<b>151.94.201</b>
	50 mm	Ø 44 mm	<b>151.94.202</b>
Matt nickel	39 mm	Ø 35 mm	<b>151.94.601</b>
	50 mm	Ø 44 mm	<b>151.94.602</b>
Aluminium coloured	39 mm	Ø 35 mm	<b>151.94.401</b>

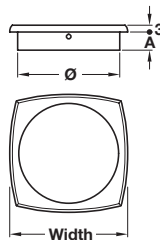

### MAGNUS inset handle

- > Order M4 handle screws separately
- > Brass, polished chrome finish with aluminium coloured inner
- > Order qty: 1 pc



Finish	Width	Diameter	Dim. A	Cat. No.
Polished chrome / Aluminium coloured	44 mm	Ø 38 mm	7 mm	<b>151.19.212</b>



Don't forget to order M4 handle screws, see page **353**  
 For our full range of fixing materials and installation tools see the Installation & Display section, pages **350-353**

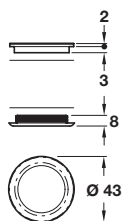

### Epte inset handle

- > Suitable for sliding glass doors 4-6 mm thick
- > Requires  $\varnothing$  37 mm hole
- > Brass
- > Order qty: 1 pc

Finish	Cat. No.
 Polished nickel-plated	154.00.727

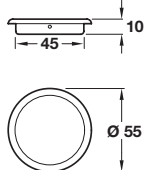

### Aaron inset handle

- > Suitable for timber cabinet/wardrobe doors
- > Order round-head metal pin,  $\varnothing$  1.6 separately
- > Steel
- > Order qty: 1 pc



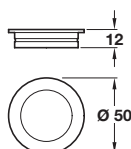

Finish	Cat. No.
 Polished nickel-plated / Matt inside	153.20.733



### Indre inset handle

- > Suitable for timber cabinet/wardrobe doors
- > Requires  $\varnothing$  42 mm hole
- > Press-in fixing
- > Zinc alloy
- > Order qty: 1 pc

Finish	Cat. No.
 Matt nickel	153.20.630
 Polished chrome	153.20.230

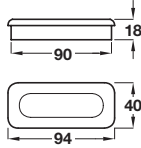

Product is subject to variations in colour and dimensions due to being manufactured from natural materials

### MONTONE inset handle

- > Order M4 handle screws separately
- > Unfinished wood
- > Order qty: 1 pc



Type of wood	Cat. No.
 Oak	<b>192.52.405</b>

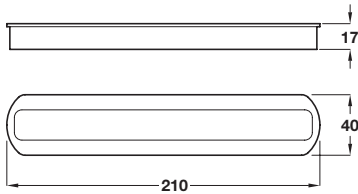

Product is subject to variations in colour and dimensions due to being manufactured from natural materials

### HALKIN inset handle

- > Order M4 handle screws separately
- > Unfinished wood
- > Order qty: 1 pc



Type of wood	Cat. No.
 Oak	<b>192.29.422</b>



Don't forget to order M4 handle screws, see page **353**  
For our full range of fixing materials and installation tools see the Installation & Display section, pages **350-353**



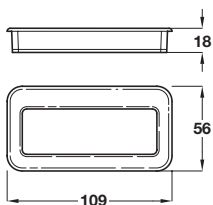

### VIENNE Inset handle

- > Order M4 handle screws separately
- > Zinc alloy
- > Order qty: 1 pc



Finish	Cat. No.
 Matt chrome	151.35.208

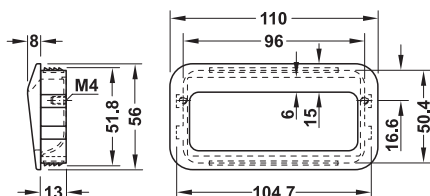

### AVEBURY Inset handle

- > Order M4 handle screws separately
- > Harpoon-type fixing
- > Zinc alloy
- > Order qty: 1 pc



Finish	Cat. No.
 Matt nickel	155.00.540

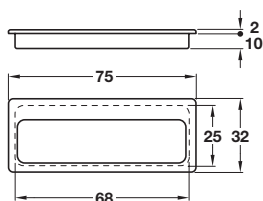

### CAVU Inset handle

- > Order round-head metal pin, Ø 1.6 mm separately
- > Steel
- > Order qty: 1 pc



Finish	Cat. No.
 Matt black	151.00.312

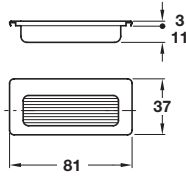

### ROYA inset handle

- > Order round-head metal pin, Ø 1.6 separately
- > Brass
- > Order qty: 1 pc



Finish	Cat. No.
 Polished chrome / Matt black inside	<b>151.14.235</b>

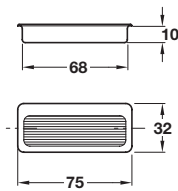

### AROS inset handle

- > Order round-head metal pin, Ø 1.6 separately
- > Brass
- > Order qty: 1 pc



Finish	Cat. No.
 Polished chrome / Matt inside	<b>155.01.545</b>

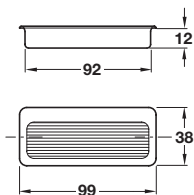

### BESBRE inset handle

- > Order round-head metal pin, Ø 1.6 separately
- > Brass
- > Order qty: 1 pc



Finish	Cat. No.
 Polished chrome / Matt inside	<b>155.01.546</b>



Don't forget to order M4 handle screws, see page **353**  
 For our full range of fixing materials and installation tools see the Installation & Display section, pages **350-353**

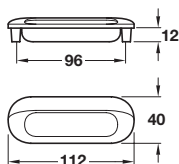

### RHIN Inset handle

- > Order M4 handle screws separately
- > Zinc alloy
- > Order qty: 1 pc



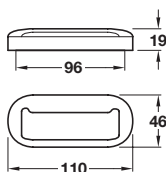

Finish	Cat. No.
 Polished chrome / Aluminium coloured inside	<b>151.17.209</b>



### AUTHIE Pull handle

- > Order M4 handle screws separately
- > Zinc alloy
- > Order qty: 1 pc



Finish	Cat. No.
 Aluminium coloured	<b>151.37.256</b>
 Matt nickel	<b>151.37.658</b>



Don't forget to order M4 handle screws, see page **353**  
For our full range of fixing materials and installation tools see the Installation & Display section, pages **350-353**

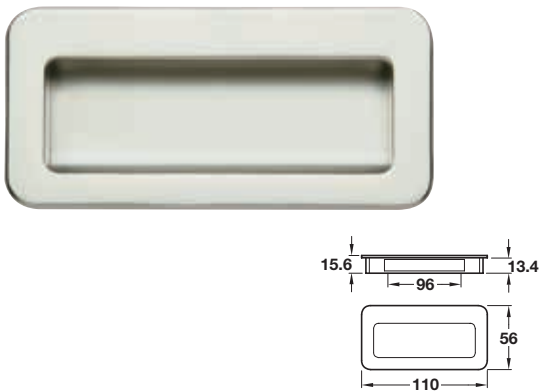
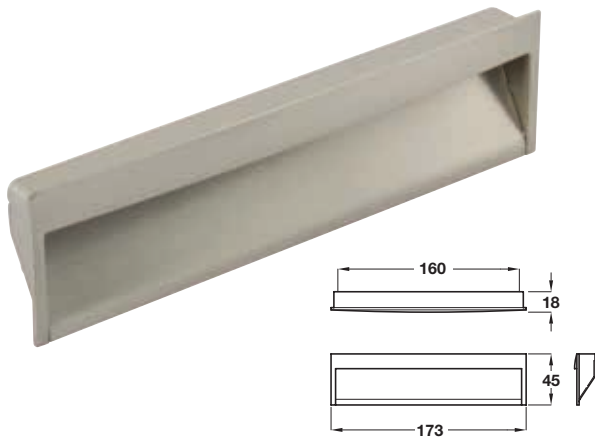

**!** These handles should only be used with solid doors

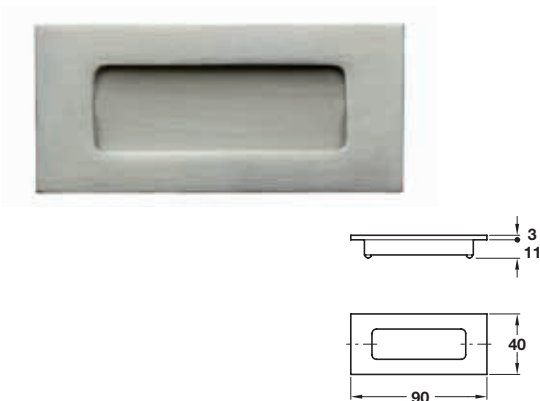

### CAVENDISH inset handle

- > 2x M4 x 25 mm handle screws included
- > Zinc alloy
- > Order qty: 1 pc





Finish	Cat. No.
 Stainless steel effect	<b>151.11.613</b>

### BLAVET Inset handle

- > Harpoon or screw fixing
- > Order M4 handle screws separately
- > Zinc alloy
- > Order qty: 1 pc



Finish	Cat. No.
 Matt chrome	<b>151.35.262</b>
 Matt nickel-plated	<b>151.35.665</b>

### MAINE inset handle

- > Concealed fixing
- > 2x Ø 3.5 x 20 mm screws included
- > Brass
- > Order qty: 1 pc



Finish	Cat. No.
 Stainless steel effect	<b>151.73.601</b>

# Cubic



Matt white finish shown on both gloss dark grey or dark wood doors



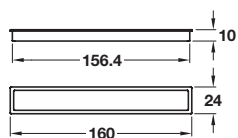

Matt black finish shown on both gloss dark grey or dark wood doors



## CUBIC inset handle

- > Press-in fixing
- > Zinc alloy
- > Order qty: 1 pc



Finish	Cat. No.
 Matt white	151.11.640
 Matt black	151.11.641

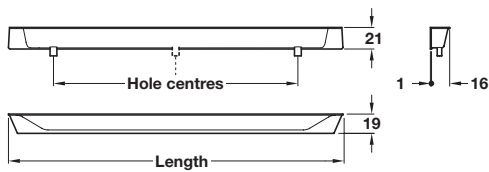

### SINTESI Inset handle



- > Order M4 handle screws separately
- > Zinc alloy
- > Order qty: 1 pc



Finish	Length	Hole centres	Cat. No.
Polished chrome	200 mm	128 mm	<b>111.44.282</b>

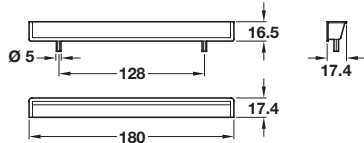

### HIDE Inset handle



- > Ø 5 mm lugs
- > Zinc alloy
- > Order qty: 1 pc

Finish	Cat. No.
Stainless steel effect	<b>151.47.662</b>
Matt white	<b>151.47.664</b>
Matt black	<b>151.47.665</b>

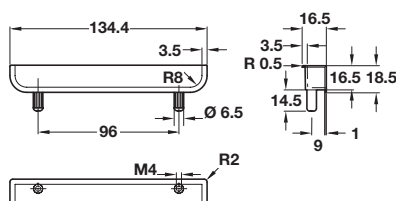

### KATO inset handle

- > Press fit with Ø 6.5 mm lugs
- > Zinc alloy, pol. stainless steel effect with brushed edges
- > Order qty: 1 pc

Finish	Length	Hole centres	Cat. No.
Polished stainless steel effect	134.4 mm	96 mm	<b>126.54.090</b>

# Pellipar



AT A GLANCE

KITCHEN APPLICATIONS

BEDROOM APPLICATIONS

BATHROOM APPLICATIONS

HANDLE FREE APPLICATIONS

INSTALLATION & DISPLAY

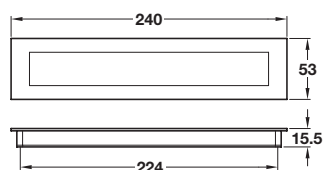

### PELLIPAR inset handle frame and backplate set

- > Reversible backplate included, white/silver reverse
- > Zinc alloy
- > Order qty: 1 pc



Finish	Cat. No.
 Stainless steel effect	153.22.000



Don't forget to order M4 handle screws, see page **353**  
 For our full range of fixing materials and installation tools see the Installation & Display section, pages **350-353**

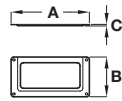

### Label frame

- > Order Ø 1.6 mm pins separately
- > Face fixing
- > Steel
- > Order qty: Multiples of 5 pcs



Finish	Dim. A	Dim. B	Dim. C	Cat. No.
Satin nickel-plated	69 mm	35 mm	2 mm	<b>168.02.761</b>
	93 mm	42 mm	2 mm	<b>168.02.770</b>



## BESPOKE TIMBER DRAWERS

Kitchen drawers are becoming an increasingly popular alternative to traditional cabinets. Our drawer range includes many different sizes and finishes, including a handcrafted, bespoke-sized timber option.



Walnut



Ply

Our Bespoke Timber Drawers are handmade in the UK from high grade solid timber. There are a number of design and personalisation choices available including a choice of wood types and come complete with dove-tailed joints.

The Häfele to Order service takes the manufacture, finishing, packaging and delivery off your hands, saving you time and money.



Oak

Find out more at [www.hafele.co.uk/bespoke-timber-drawers](http://www.hafele.co.uk/bespoke-timber-drawers)



# ASPEKT KITCHEN CABINET DOORS FROM HÄFELE



Hampstead Ultragloss Aqua Blue

Introducing our NEW collection of kitchen cabinet doors. Manufactured in the UK and with the FIRA Gold quality seal of approval, these doors come with a Häfele lifetime guarantee\*.

Our range of door sizes make an easy job of designing kitchens, including built-in appliances. Visit [www.hafele.co.uk/aspekt-doors](http://www.hafele.co.uk/aspekt-doors) to see the full range.

Key features include:

- > 18 colours and finishes
- > FIRA Gold approved
- > Free 48 hour delivery\*
- > No minimum order quantity

\*Ts & Cs apply



Skye Matt Midnight Blue



York Matt Slate Grey



Stirling Gloss Dove Grey

Visit [hafele.co.uk/aspekt-doors](http://hafele.co.uk/aspekt-doors) to view the full range

## Bartram

AT A GLANCE

KITCHEN APPLICATIONS

BEDROOM APPLICATIONS

BATHROOM APPLICATIONS

HANDLE FREE APPLICATIONS

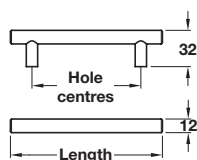

INSTALLATION & DISPLAY



### BARTRAM bar handle

- > \*2x M4 x 20 mm, 2x M4 x 22 mm and 2x M4 x 25 mm screws included
- > Steel
- > Order qty: 1 pc



Finish	Length	Hole centres	Cat. No.
 Antique copper	178 mm	128 mm	<b>117.97.062</b>
	220 mm	160 mm	<b>117.97.063*</b>
 Brushed oil rubbed bronze	178 mm	128 mm	<b>117.97.162</b>
	220 mm	160 mm	<b>117.97.163</b>



Don't forget to order M4 handle screws, see page **353**

For our full range of fixing materials and installation tools see the Installation & Display section, pages **350-353**

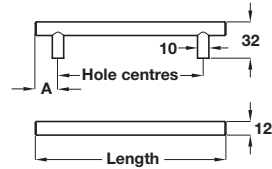

### BARKSTON bar handle, Ø 12 mm

- > \*2 each of M4 x 45 mm snap off handle screws included (101.20.700 includes an additional 1x M4 x 25 mm screw)
- > Order M4 handle screws separately
- > Steel
- > Order qty: 1 pc



Finish	Length	Hole centres	Dim. A	Cat. No.
Stainless steel effect	136 mm	96 mm	20 mm	<b>101.20.709</b>
	168 mm	128 mm	20 mm	<b>101.20.700*</b>
	226 mm	156 mm	35 mm	<b>101.20.701*</b>
	230 mm	160 mm	35 mm	<b>101.20.710*</b>
	232 mm	192 mm	20 mm	<b>101.20.708</b>
	326 mm	256 mm	35 mm	<b>101.20.702*</b>
	376 mm	306 mm	35 mm	<b>101.20.703*</b>
	426 mm	356 mm	35 mm	<b>101.20.704</b>
	526 mm	456 mm	35 mm	<b>101.20.705</b>
	702 mm	632 mm	35 mm	<b>101.20.706</b>
828 mm	758 mm	35 mm	<b>101.20.707*</b>	

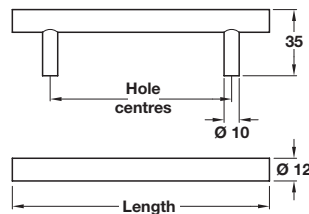

### BELLA bar handle, Ø 12 mm

- > Order M4 handle screws separately
- > Steel
- > Order qty: 1 pc



Finish	Length	Hole centres	Cat. No.
Polished chrome	136 mm	96 mm	<b>117.97.224</b>
	168 mm	128 mm	<b>117.97.225</b>
	200 mm	160 mm	<b>117.97.218</b>
	232 mm	192 mm	<b>117.97.227</b>
	328 mm	288 mm	<b>117.97.219</b>
	392 mm	352 mm	<b>117.97.229</b>

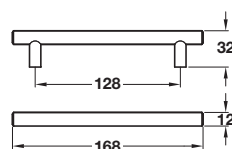

### PUMA bar handle

- > Order M4 handle screws separately
- > Steel
- > Order qty: 1 pc



Finish	Cat. No.
Matt black epoxy	<b>101.20.325</b>

## Pimlico

AT A GLANCE

KITCHEN APPLICATIONS

BEDROOM APPLICATIONS

BATHROOM APPLICATIONS

HANDLE FREE APPLICATIONS

INSTALLATION & DISPLAY

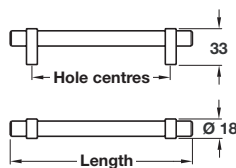

### PIMLICO bar handle

- > Order M4 handle screws separately
- > Steel bar with zinc alloy feet
- > Order qty: 1 pc



Finish	Length	Hole centres	Cat. No.
Stainless steel effect	168 mm	128 mm	<b>115.66.045</b>
	232 mm	192 mm	<b>115.66.045</b>
	264 mm	224 mm	<b>115.66.047</b>
	424 mm	384 mm	<b>115.66.048</b>



Don't forget to order M4 handle screws, see page **353**  
For our full range of fixing materials and installation tools see the Installation & Display section, pages **350-353**

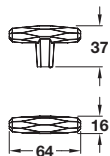
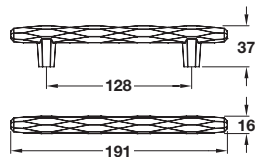

# St. Vincent



## ST. VINCENT pull handle

- > 2x 8/32 x 1" (non-metric) screws included
- > Zinc alloy
- > Order qty: 1 pc





Finish	Cat. No.
 Polished nickel	<b>133.50.388</b>
 Golden champagne	<b>133.50.382</b>

## ST. VINCENT T knob

- > 1x 8/32 x 1" (non-metric) screw included
- > Zinc alloy
- > Order qty: 1 pc



Finish	Cat. No.
 Polished nickel	<b>133.50.641</b>
 Golden champagne	<b>133.50.639</b>



All handles on this page include 8/32 x 1" (non-metric) screws. If you require a different length order non-metric cut off screw Cat. No. 022.24.881 shown on page **353**

## Boston

AT A GLANCE

KITCHEN APPLICATIONS

BEDROOM APPLICATIONS

BATHROOM APPLICATIONS

HANDLE FREE APPLICATIONS

INSTALLATION & DISPLAY

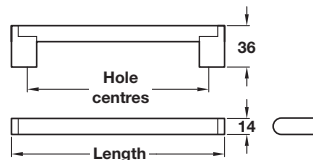

### BOSTON boss bar handle

- > Order M4 handle screws separately
- > \*2x M4 x 25 mm, 2x M4 x 25 mm and 2x M4 x 28 mm screws included
- > Zinc alloy ends, with hollow stainless steel tube or solid steel bar
- > Order qty: 1 pc



Finish	Length	Hole centres	Cat. No.
Stainless steel effect	<b>Hollow stainless steel tube</b>		
	156 mm	128 mm	<b>115.69.002</b>
	188 mm	160 mm	<b>115.69.003*</b>
	220 mm	192 mm	<b>115.69.004</b>
	237 mm	209 mm	<b>104.74.011</b>
	284 mm	256 mm	<b>115.69.006</b>
	337 mm	309 mm	<b>104.74.012</b>
	348 mm	320 mm	<b>115.69.008</b>
	387 mm	359 mm	<b>104.74.013</b>
	437 mm	409 mm	<b>104.74.014</b>
	476 mm	448 mm	<b>115.69.009</b>
	537 mm	509 mm	<b>104.74.015</b>
	<b>Solid steel bar</b>		
	751 mm	709 mm	<b>104.74.016</b>
	849 mm	807 mm	<b>104.74.017</b>
951 mm	909 mm	<b>104.74.018</b>	
1199 mm	1157 mm	<b>104.74.019</b>	

FURNITURE HANDLES 2021, © Häfele U.K. Ltd 2021. Dimensional data not binding. We reserve the right to alter specifications without notice.

# Osaka

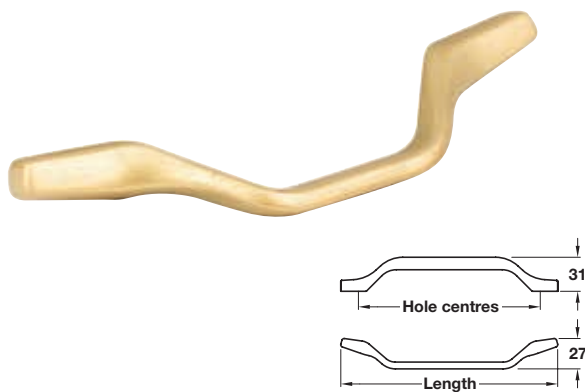

## OSAKA pull handle

- > Fixings included:  
Satin brass - 2x M4 x 50 mm snap-off handle screws  
Antique copper and graphite - 2 each of M4 x 22 mm and M4 x 26 mm handle screws
- > Zinc alloy
- > Order qty: 1 pc



Finish	Length	Hole centres	Cat. No.
Satin brass	127 mm	96 mm	<b>110.22.080</b>
	191 mm	160 mm	<b>110.22.081</b>
Antique copper	191 mm	160 mm	<b>110.22.086</b>
	351 mm	320 mm	<b>110.22.089</b>
Graphite	191 mm	160 mm	<b>110.22.586</b>

## Level

AT A GLANCE

KITCHEN APPLICATIONS

BEDROOM APPLICATIONS

BATHROOM APPLICATIONS

HANDLE FREE APPLICATIONS

INSTALLATION & DISPLAY

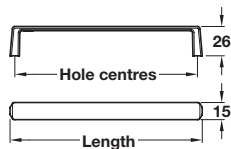

### LEVEL pull handle

- > Order M4 handle screws separately
- > Zinc alloy
- > Order qty: 1 pc



Finish	Length	Hole centres	Cat. No.
 Matt anthracite	72 mm	64 mm	<b>111.71.505</b>
	168 mm	160 mm	<b>111.71.506</b>
	328 mm	320 mm	<b>111.71.507</b>



# Oval



AT A GLANCE

KITCHEN APPLICATIONS

BEDROOM APPLICATIONS

BATHROOM APPLICATIONS

HANDLE FREE APPLICATIONS

INSTALLATION & DISPLAY

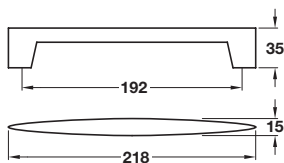

Product is subject to variations in colour and dimensions due to being manufactured from natural materials

## OVAL handle

- > Order M4 handle screws separately
- > Walnut, lacquered
- > Order qty: 1 pc



Finish	Cat. No.
 Walnut	193.18.757



Don't forget to order M4 handle screws, see page **353**  
For our full range of fixing materials and installation tools see the Installation & Display section, pages **350-353**

Twist

AT A GLANCE

KITCHEN APPLICATIONS

BEDROOM APPLICATIONS

BATHROOM APPLICATIONS

HANDLE FREE APPLICATIONS

INSTALLATION & DISPLAY

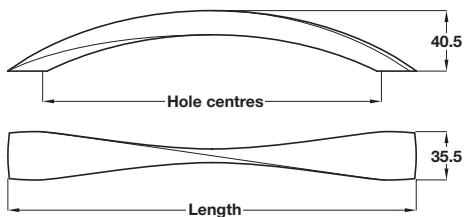

Product is subject to variations in colour and dimensions due to being manufactured from natural materials

**TWIST pull handle**

- > Order M4 handle screws separately
- > Oak
- > Order qty: 1 pc



Finish	Length	Hole centres	Cat. No.
Oak unfinished	270 mm	224 mm	<b>193.43.428</b>
	388 mm	320 mm	<b>193.43.429</b>



➔ Don't forget to order M4 handle screws, see page **353**  
 For our full range of fixing materials and installation tools see the Installation & Display section, pages **350-353**

# VIEW OUR COMPLETE HÄFELE DRESSCODE BEDROOM RANGE 24/7



Dresscode aluminium frame

Häfele Dresscode is an optimised wardrobe solution with stylish design. All components can be installed in an existing wardrobe or an easy to assemble aluminium frame system.

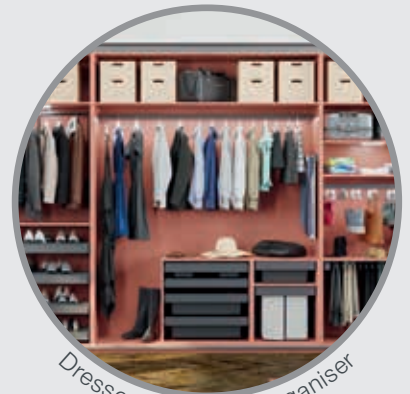

Dresscode cabinet organiser

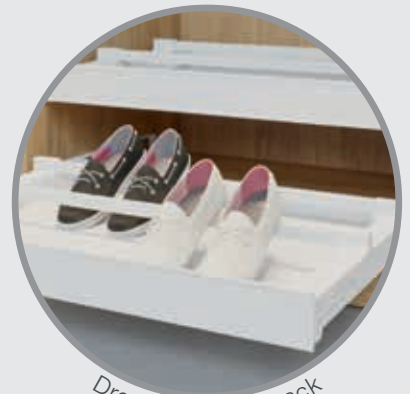

Dresscode shoe rack



Dresscode laundry bag

VISIT [HAFELE.CO.UK](https://www.hafele.co.uk) TO VIEW THE FULL RANGE

## Graf & Graf 2

AT A GLANCE

KITCHEN APPLICATIONS

BEDROOM APPLICATIONS

BATHROOM APPLICATIONS

HANDLE FREE APPLICATIONS

INSTALLATION & DISPLAY

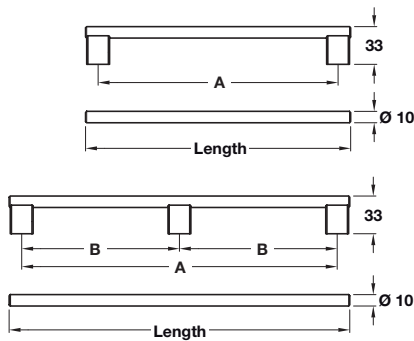
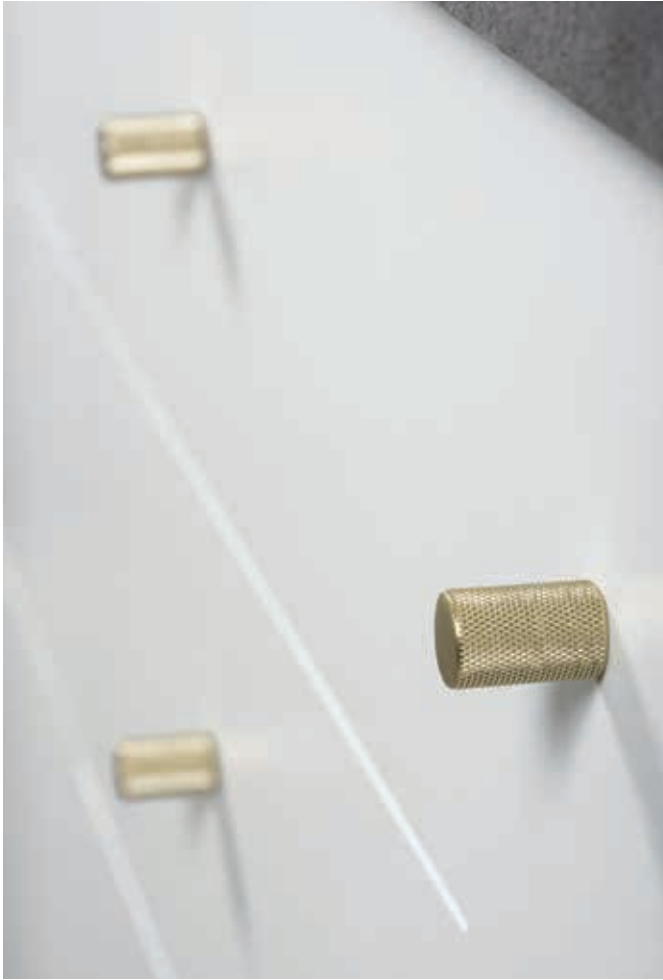

### GRAF 2 bar handle

- > 2/3x M4 x 25 mm handle screws included
- > Aluminium
- > Order qty: 1 pc



Finish	Length	Hole centres		Cat. No.
		A	B	
Stainless steel effect	182 mm	160 mm	-	<b>132.19.110</b>
	278 mm	256 mm	-	<b>132.19.111</b>
	1200 mm	1178 mm	589 mm	<b>132.19.112</b>
Black	182 mm	160 mm	-	<b>132.19.115</b>
	278 mm	256 mm	-	<b>132.19.116</b>
	1200 mm	1178 mm	589 mm	<b>132.19.117</b>
Brushed dark brass	182 mm	160 mm	-	<b>132.19.120</b>
	278 mm	256 mm	-	<b>132.19.121</b>
	1200 mm	1178 mm	589 mm	<b>132.19.122</b>

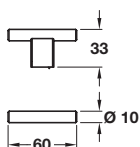

### GRAF 2 T knob

- > 1x M4 x 25 mm handle screw included
- > Aluminium
- > Order qty: 1 pc



Finish	Cat. No.
Stainless steel effect	132.19.105
Black	132.19.106
Brushed dark brass	132.19.107

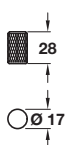

### GRAF knob

- > 1x M4 x 25 mm handle screw included
- > Aluminium
- > Order qty: 1 pc



Finish	Cat. No.
Polished chrome	132.15.230
Brushed brass	132.19.210
Matt black	132.19.211
Stainless steel effect	132.15.630
Brushed dark brass	106.60.318

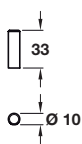

### GRAF 2 cylindrical knob

- > 1x M4 x 25 mm handle screw included
- > Aluminium
- > Order qty: 1 pc



Finish	Cat. No.
Stainless steel effect	132.19.100
Black	132.19.101
Brushed dark brass	132.19.102

## Graf Big

AT A GLANCE

KITCHEN APPLICATIONS

BEDROOM APPLICATIONS

BATHROOM APPLICATIONS

HANDLE FREE APPLICATIONS

INSTALLATION & DISPLAY

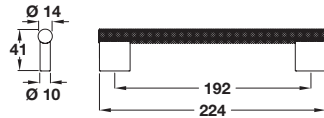

### GRAF BIG bar handle

- > 2x M4 x 25 mm handle screws included
- > Aluminium
- > Order qty: 1 pc



Finish	Cat. No.
Stainless steel effect	106.66.112
Brushed black	106.66.110
Brushed dark brass	106.66.111



### GRAF BIG knob

- > 1x M4 x 25 mm handle screw included
- > Aluminium
- > Order qty: 1 pc



Finish	Ø 38 mm	Ø 50 mm
Stainless steel effect	106.66.102	106.66.105
Brushed black	106.66.100	106.66.103
Dark brass	106.66.101	106.66.104

# Tarvos, Encanto & Rhea

The Tarvos, Encanto and Rhea are textured furniture handles in a graphite finish with three designs of bar handles to choose from. Use to contrast or coordinate, the textured finish gives added style and makes the handle a pleasure to use

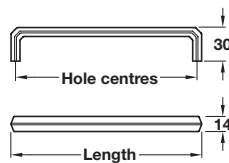

### TARVOS pull handle

- > 2x M4 x 22 mm handles screws included
- > Zinc alloy
- > Order qty: 1 pc



Finish	Length	Hole centres	Cat. No.
Matt black	136 mm	128 mm	<b>113.96.120</b>
	168 mm	160 mm	<b>113.96.121</b>

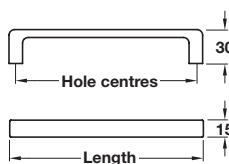

### ENCANTO pull handle

- > 2x M4 x 22 mm handles screws included
- > Zinc alloy
- > Order qty: 1 pc



Finish	Length	Hole centres	Cat. No.
Matt black	172 mm	160 mm	<b>113.96.100</b>
	332 mm	320 mm	<b>113.96.101</b>

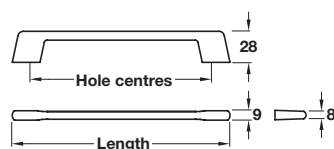

### RHEA pull handle

- > 2x M4 x 22 mm handles screws included
- > Zinc alloy
- > Order qty: 1 pc



Finish	Length	Hole centres	Cat. No.
Matt black	153 mm	128 mm	<b>113.96.110</b>
	185 mm	160 mm	<b>113.96.111</b>

## U

AT A GLANCE

KITCHEN APPLICATIONS

BEDROOM APPLICATIONS

BATHROOM APPLICATIONS

HANDLE FREE APPLICATIONS

INSTALLATION & DISPLAY

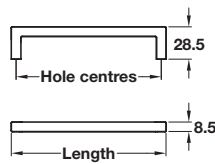
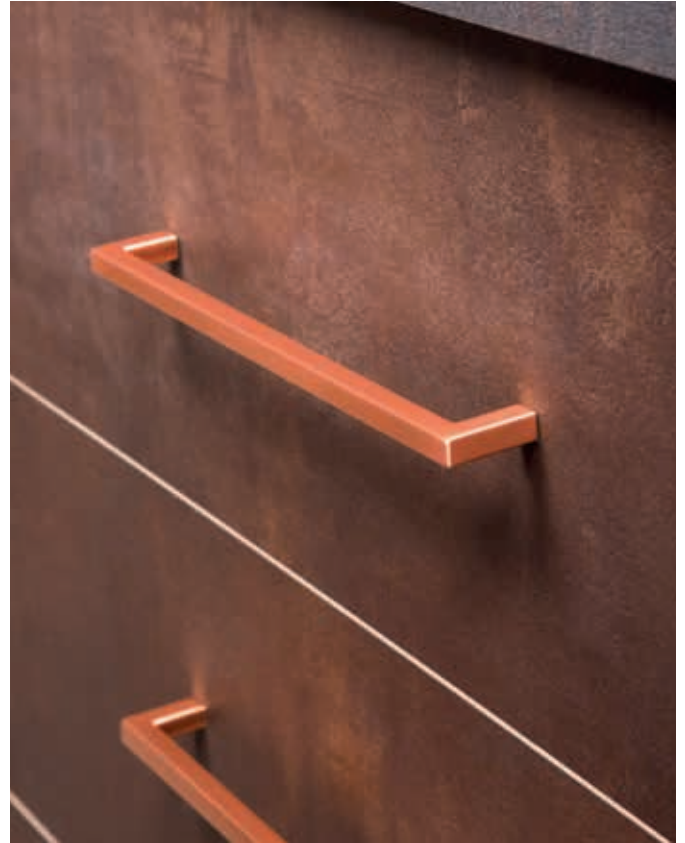

### U pull handle

- > 2x M4 x 25 mm handle screws included
- > Zinc alloy
- > Order qty: 1 pc



Finish	Length	Hole centres	Cat. No.
 Matt black	136.5 mm	128 mm	<b>108.66.385</b>
	200.5 mm	192 mm	<b>108.66.397</b>
	328.5 mm	320 mm	<b>108.66.386</b>
	500.5 mm	492 mm	<b>108.66.387</b>
 Polished chrome	136.5 mm	128 mm	<b>108.66.285</b>
	200.5 mm	192 mm	<b>108.66.380</b>
	328.5 mm	320 mm	<b>108.66.286</b>
	500.5 mm	492 mm	<b>108.66.287</b>
 Brushed brass	136.5 mm	128 mm	<b>108.66.388</b>
	200.5 mm	192 mm	<b>108.66.389</b>
	328.5 mm	320 mm	<b>108.66.390</b>
	500.5 mm	492 mm	<b>108.66.391</b>
 Brushed copper	136.5 mm	128 mm	<b>108.66.376</b>
	200.5 mm	192 mm	<b>108.66.377</b>
	328.5 mm	320 mm	<b>108.66.378</b>
	500.5 mm	492 mm	<b>108.66.379</b>



# Este



AT A GLANCE

KITCHEN APPLICATIONS

BEDROOM APPLICATIONS

BATHROOM APPLICATIONS

HANDLE FREE APPLICATIONS

INSTALLATION & DISPLAY

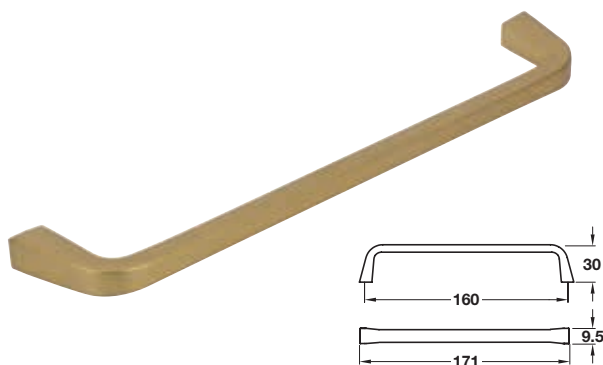

### ESTE pull handle

- > 2x M4 x 25 mm handle screws included
- > Zinc alloy
- > Order qty: 1 pc



Finish	Cat. No.
 Matt black	108.66.456
 Brushed nickel	108.66.446
 Brushed gold	108.66.445
 Brushed copper	108.66.455



➔ The COMO knob shown on page 265 matches the ESTE pull handle

## Burbridge

AT A GLANCE

KITCHEN APPLICATIONS

BEDROOM APPLICATIONS

BATHROOM APPLICATIONS

HANDLE FREE APPLICATIONS

INSTALLATION & DISPLAY

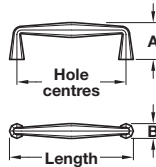

\*Product is subject to variations in finish due to the finishing and manufacturing process of certain materials

### BURBRIDGE pull handle



- > 2x M4 x 25 mm handle screws included
- > Brass or cast iron
- > Order qty: 1 pc



Finish	Length	Hole centres	Dim. A	Dim. B	Cat. No.
Polished nickel, brass	144 mm	128 mm	35 mm	15 mm	<b>116.35.745</b>
	176 mm	160 mm	37 mm	15 mm	<b>116.35.746</b>
Brushed brass, brass*	144 mm	128 mm	35 mm	15 mm	<b>116.35.545</b>
Antique copper, brass	144 mm	128 mm	35 mm	15 mm	<b>116.35.945</b>
Cast iron*	109 mm	96 mm	33 mm	13 mm	<b>116.35.344</b>
	212 mm	192 mm	40 mm	17 mm	<b>116.35.347</b>

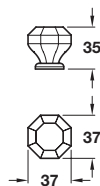

\*Product is subject to variations in finish due to the finishing and manufacturing process of certain materials

### BURBRIDGE knob



- > 1x M4 x 25 mm handle screw included
- > Brass
- > Order qty: 1 pc



Finish	Cat. No.
Brushed brass*	<b>123.03.510</b>
Polished nickel	<b>123.03.710</b>

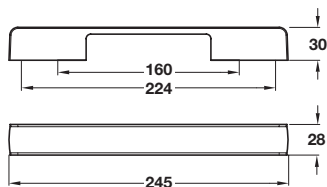

### BLANCO D handle

- > Order M4 handle screws separately
- > Zinc alloy, with acrylic centres
- > Order qty: 1 pc



Finish	Cat. No.
Polished chrome with white insert	<b>111.21.273</b>

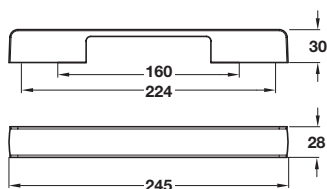

### NOIR D handle

- > Order M4 handle screws separately
- > Zinc alloy, with acrylic centres
- > Order qty: 1 pc



Finish	Cat. No.
Polished chrome with black insert	<b>111.21.233</b>

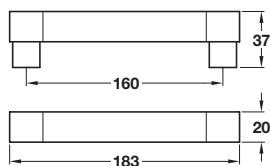

### DOMINO bar handle

- > Order M4 handle screws separately
- > Zinc alloy, polished chrome with leather effect centre
- > Order qty: 1 pc



Finish	Length	Hole centres	Cat. No.
Black	151 mm	128 mm	<b>113.98.232</b>
	183 mm	160 mm	<b>113.98.233</b>
Brown	151 mm	128 mm	<b>113.98.212</b>
	247 mm	224 mm	<b>113.98.215</b>

FURNITURE HANDLES 2021, © Häfele U.K. Ltd 2021. Dimensional data not binding. We reserve the right to alter specifications without notice.



Don't forget to order M4 handle screws, see page **353**

For our full range of fixing materials and installation tools see the Installation & Display section, pages **350-353**

## Crystal

AT A GLANCE

KITCHEN APPLICATIONS

BEDROOM APPLICATIONS

BATHROOM APPLICATIONS

HANDLE FREE APPLICATIONS

INSTALLATION & DISPLAY

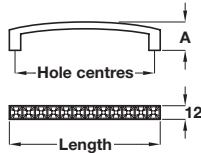

### CRYSTAL D handle

- > Order M4 handle screws separately
- > Made with CRYSTALLIZED™ Swarovski Elements
- > Zinc alloy
- > Order qty: 1 pc



Finish	Length	Hole centres	Dim. A	Cat. No.
	107 mm	96 mm	22 mm	<b>103.29.221</b>
	140 mm	128 mm	25 mm	<b>103.29.222</b>

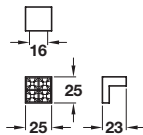

### CRYSTAL pull handle

- > Order M4 handle screws separately
- > Made with CRYSTALLIZED™ Swarovski Elements
- > Zinc alloy
- > Order qty: 1 pc



Finish	Cat. No.
Polished chrome	<b>132.19.240</b>

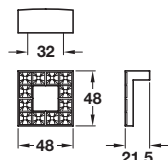

### CRYSTAL pull handle

- > 2x M4 x 25 mm handle screws included
- > Made with CRYSTALLIZED™ Swarovski Elements
- > Zinc alloy
- > Order qty: 1 pc



Finish	Cat. No.
Polished chrome	<b>132.19.220</b>

# Glacio

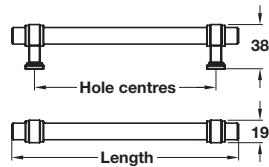

## GLACIO pull handle

- > 2x 8/32 x 1" (non-metric) screws included
- > Zinc/Glass
- > Order qty: 1 pc



Finish	Length	Hole centres	Cat. No.
Polished nickel / Clear	167 mm	128 mm	<b>133.53.039</b>
	200 mm	160 mm	<b>133.53.040</b>

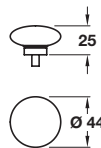

## GLACIO knob

- > 1x 8/32 x 1" (non-metric) screw included
- > Zinc/Glass
- > Order qty: 1 pc



Finish	Cat. No.
Polished nickel / Clear	<b>133.50.122</b>

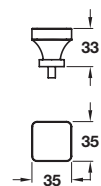

## GLACIO square knob

- > 1x 8/32 x 1" (non-metric) screw included
- > Zinc/Glass
- > Order qty: 1 pc



Finish	Cat. No.
Polished nickel / Clear	<b>133.50.120</b>



All handles on this page include 8/32 x 1" (non-metric) screws. If you require a different length order non-metric cut off screw Cat. No. 022.24.881 shown on page **353**

## Byron

AT A GLANCE

KITCHEN APPLICATIONS

BEDROOM APPLICATIONS

BATHROOM APPLICATIONS

HANDLE FREE APPLICATIONS

INSTALLATION & DISPLAY

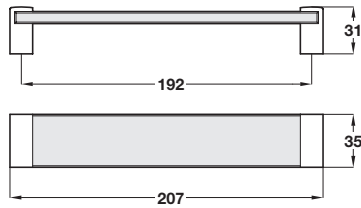

### BYRON bar handle

- > 2x M4 x 25 mm handle screws included
- > Zinc alloy, with tempered glass
- > Order qty: 1 pc



Finish	Cat. No.
 Polished chrome with clear glass	<b>108.80.507</b>

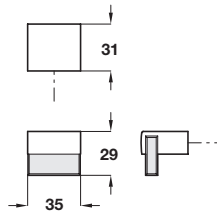

### BYRON knob

- > 1x M4 x 25 mm handle screw included
- > Zinc alloy, with tempered glass
- > Order qty: 1 pc



Finish	Cat. No.
 Polished chrome with clear glass	<b>131.14.200</b>

# Glitter

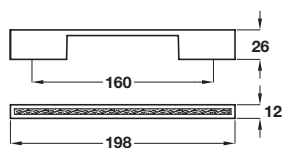

### GLITTER D handle

- > Order M4 handle screws separately
- > Zinc alloy
- > Order qty: 1 pc



Finish	Cat. No.
 Polished chrome with glitter inner, sealed	<b>110.22.253</b>

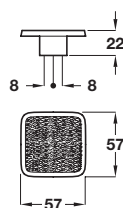

### GLITTER knob

- > Order M4 handle screws separately
- > Zinc alloy
- > Order qty: 1 pc



Finish	Cat. No.
 Polished chrome with glitter inner, sealed	<b>132.15.220</b>

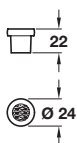

### GLITTER knob

- > Order M4 handle screws separately
- > Zinc alloy
- > Order qty: 1 pc



Finish	Cat. No.
 Polished chrome with glitter inner, sealed	<b>132.15.210</b>

FURNITURE HANDLES 2021, © Häfele U.K. Ltd 2021. Dimensional data not binding. We reserve the right to alter specifications without notice.

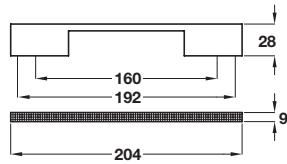

### DISCO pull handle

- > Order M4 handle screws separately
- > Zinc alloy
- > Order qty: 1 pc



Finish	Cat. No.
 Polished chrome	<b>110.22.243</b>

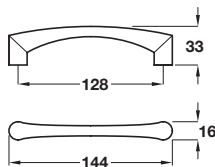

### EMERSON D handle

- > 2x M4 x 45 mm snap off handle screws included
- > Zinc alloy
- > Order qty: 1 pc



Finish	Cat. No.
 Matt nickel	<b>101.71.022</b>



Don't forget to order M4 handle screws, see page **353**  
For our full range of fixing materials and installation tools see the Installation & Display section, pages **350-353**



# Dimple

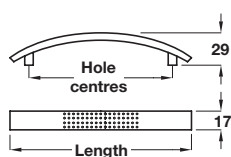

## DIMPLE bow handle

- > Order M4 handle screws separately
- > Zinc alloy
- > Order qty: 1 pc



Finish	Length	Hole centres	Cat. No.
Polished chrome	126 mm	96 mm	<b>101.69.201</b>
	158 mm	128 mm	<b>101.69.202</b>
Matt nickel	126 mm	96 mm	<b>101.69.601</b>
	158 mm	128 mm	<b>101.69.602</b>
Stainless steel effect	126 mm	96 mm	<b>101.69.001</b>
	158 mm	128 mm	<b>101.69.002</b>

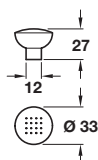

## DIMPLE knob

- > Order M4 handle screws separately
- > \*1x M4 x 25 mm screw included
- > Zinc alloy
- > Order qty: 1 pc



Finish	Cat. No.
Polished chrome	<b>135.48.202</b>
Matt nickel	<b>135.48.402</b>
Stainless steel effect	<b>135.48.002*</b>

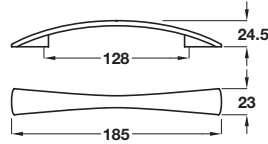

### QUIGLEY bow handle

- > Order M4 handle screws separately
- > Zinc alloy
- > Order qty: 1 pc



Finish	Cat. No.
Polished chrome	109.29.202
Matt nickel	109.29.602
Aluminium coloured	109.29.402

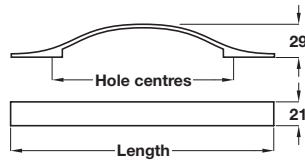

### CHISWICK bow handle

- > Order M4 handle screws separately
- > Zinc alloy
- > Order qty: 1 pc



Finish	Length	Hole centres	Cat. No.
Polished chrome	232 mm	160 mm	108.89.243
Stainless steel effect			108.89.043

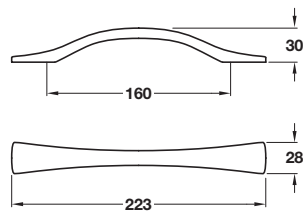

### TARA bow handle

- > Order M4 handle screws separately
- > Zinc alloy
- > Order qty: 1 pc



Finish	Cat. No.
Matt nickel	105.77.603



Don't forget to order M4 handle screws, see page **353**  
For our full range of fixing materials and installation tools see the Installation & Display section, pages **350-353**

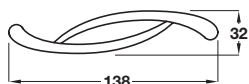
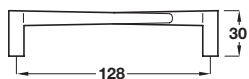

### SOPHIA pull handle

- > Order M4 handle screws separately
- > Zinc alloy
- > Order qty: 1 pc



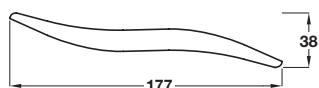
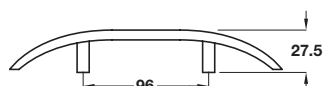

Finish	Cat. No.
 Matt nickel	101.50.602



### SILAS bar handle

- > Order M4 handle screws separately
- > Zinc alloy
- > Order qty: 1 pc



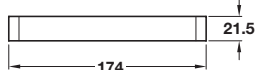
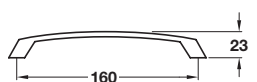

Finish	Cat. No.
 Matt nickel	103.36.600
 Polished chrome	103.36.201



### TAVISTOCK bow handle

- > 2 each of M4 x 22 mm and M4 x 25 mm handle screws included
- > \*2x M4 x 45 mm snap off handle screws included
- > Aluminium
- > Order qty: 1 pc



Finish	Cat. No.
 Polished chrome	109.53.226
 Stainless steel effect	109.53.626*

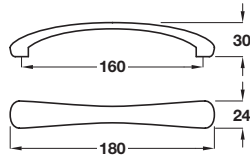

### AUBREY bow handle

- > Order M4 handle screws separately
- > Zinc alloy
- > Order qty: 1 pc



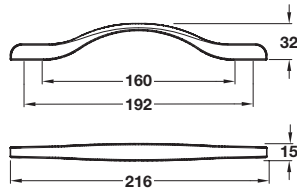

Finish	Cat. No.
 Matt nickel	<b>109.13.603</b>



### HENLEY bow handle

- > Order M4 handle screws separately
- > Zinc alloy
- > Order qty: 1 pc



Finish	Cat. No.
 Light bronze	<b>108.89.116</b>
 Graphite	<b>108.89.516</b>



Don't forget to order M4 handle screws, see page **353**  
For our full range of fixing materials and installation tools see the Installation & Display section, pages **350-353**

# Arco



AT A GLANCE

KITCHEN APPLICATIONS

BEDROOM APPLICATIONS

BATHROOM APPLICATIONS

HANDLE FREE APPLICATIONS

INSTALLATION & DISPLAY

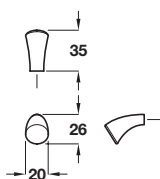
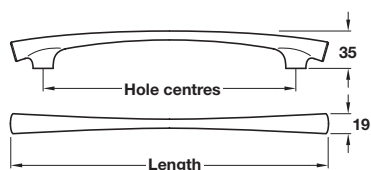

## ARCO bow handle

- > Order M4 handle screws separately
- > Zinc alloy
- > Order qty: 1 pc



Finish	Length	Hole centres	Cat. No.
Stainless steel effect	185 mm	128 mm	<b>111.62.612</b>
	281 mm	224 mm	<b>111.62.615</b>
Polished chrome	185 mm	128 mm	<b>111.62.212</b>
	281 mm	224 mm	<b>111.62.215</b>



## ARCO knob

- > Order M4 handle screws separately
- > Zinc alloy
- > Order qty: 1 pc



Finish	Cat. No.
Stainless steel effect	<b>133.91.610</b>



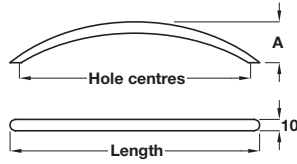

### INDIGO bow handle

- > Order M4 handle screws separately
- > Steel
- > Order qty: 1 pc



Finish	Length	Hole centres	Dim. A	Cat. No.
Polished chrome	111 mm	96 mm	30 mm	<b>117.31.222</b>
	148 mm	128 mm	30 mm	<b>117.31.231</b>
	184 mm	160 mm	32 mm	<b>117.31.241</b>
	297 mm	256 mm	32 mm	<b>117.31.261</b>
Matt black	151 mm	128 mm	30 mm	<b>106.43.302</b>
	187 mm	160 mm	32 mm	<b>106.43.303</b>

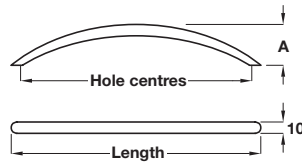

### Bow handle

- > Order M4 handle screws separately
- > Steel
- > Order qty: 1 pc



Finish	Length	Hole centres	Dim. A	Cat. No.
Aluminium coloured	118 mm	96 mm	24 mm	<b>106.43.401</b>
	151 mm	128 mm	30 mm	<b>106.43.402</b>
	187 mm	160 mm	32 mm	<b>106.43.403</b>
	320 mm	288 mm	40 mm	<b>106.43.407</b>
Polished brass	118 mm	96 mm	24 mm	<b>106.43.801</b>
	151 mm	128 mm	30 mm	<b>106.43.802</b>
	187 mm	160 mm	32 mm	<b>106.43.803</b>
	320 mm	288 mm	40 mm	<b>106.43.807</b>

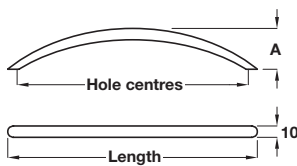

### CLIFTON bow handle

- > Order M4 handle screws separately
- > \*2x M4 handle screws included
- > Steel
- > Order qty: 1 pc



Finish	Length	Hole centres	Dim. A	Cat. No.
Brushed stainless steel effect	111 mm	96 mm	30 mm	<b>117.31.021</b>
	148 mm	128 mm	30 mm	<b>117.31.031*</b>
	184 mm	160 mm	32 mm	<b>117.31.041</b>
	221 mm	192 mm	32 mm	<b>117.31.052</b>
	258 mm	224 mm	32 mm	<b>117.31.053</b>
	332 mm	288 mm	32 mm	<b>117.31.071</b>

# Cordelia

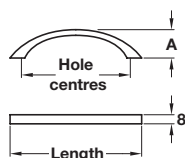

### CORDELIA bow handle

- > Order M4 handle screws separately
- > Zinc alloy
- > Order qty: 1 pc



Finish	Length	Hole centres	Dim. A	Cat. No.
Polished chrome	86.5 mm	64 mm	19 mm	<b>107.66.210</b>
	150 mm	128 mm	31 mm	<b>107.66.212</b>
	186 mm	160 mm	31.5 mm	<b>107.66.213</b>
	318 mm	288 mm	38.5 mm	<b>107.66.217</b>



Don't forget to order M4 handle screws, see page **353**  
 For our full range of fixing materials and installation tools see the Installation & Display section, pages **350-353**

## Knightsbridge

AT A GLANCE

KITCHEN APPLICATIONS

BEDROOM APPLICATIONS

BATHROOM APPLICATIONS

HANDLE FREE APPLICATIONS

INSTALLATION & DISPLAY

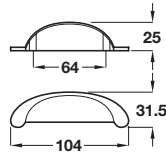

### KNIGHTSBRIDGE cup handle

- > Order M4 handle screws separately
- > Zinc alloy
- > Order qty: 1 pc



Finish	Cat. No.
 Stainless steel effect	<b>118.55.620</b>

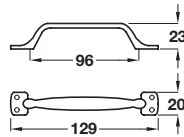

### KNIGHTSBRIDGE D handle

- > Order M4 handle screws separately
- > Zinc alloy
- > Order qty: 1 pc



Finish	Cat. No.
 Stainless steel effect	<b>118.69.620</b>



Don't forget to order M4 handle screws, see page **353**  
For our full range of fixing materials and installation tools see the Installation & Display section, pages **350-353**



# Henrietta

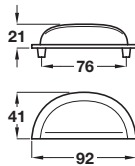

The MAYBERRY knob shown on page 133 also matches the HENRIETTA cup handle

## HENRIETTA cup handle



- > 2x M4 x 25 mm and 2x M4 x 45 mm snap off handle screws included
- > \*Order M4 handle screws separately
- > Zinc alloy
- > Order qty: 1 pc



Finish	Cat. No.
Polished chrome	<b>166.11.204*</b>
Stainless steel effect	<b>166.11.400*</b>
Polished black nickel	<b>166.11.305</b>

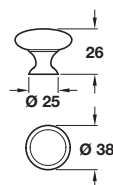

## HENRIETTA knob



- > 1x M4 x 25 mm handle screw included
- > Zinc alloy
- > Order qty: 1 pc



Finish	Cat. No.
Polished chrome	<b>134.39.210</b>
Stainless steel effect	<b>134.39.020</b>

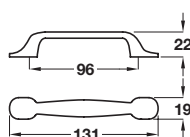

## HENRIETTA D handle



- > 2x M4 x 25 mm handles screws and 2x M4 x 45 mm snap off handle screws included
- > \*Order fixing screws separately
- > Aluminium
- > Order qty: 1 pc



Finish	Cat. No.
Polished chrome	<b>109.48.224</b>
Stainless steel effect	<b>118.53.600*</b>

## Ariel

AT A GLANCE

KITCHEN APPLICATIONS

BEDROOM APPLICATIONS

BATHROOM APPLICATIONS

HANDLE FREE APPLICATIONS

INSTALLATION & DISPLAY

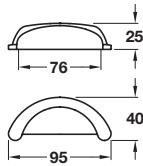

### ARIEL cup handle

- > 2 each of M4 x 20 mm, 22 mm and 27 mm handle screws included
- > \*Order fixing screws separately for polished chrome finish
- > Zinc alloy
- > Order qty: 1 pc



Finish	Cat. No.
Polished chrome	<b>166.11.240*</b>
Pewter effect	<b>166.11.905</b>

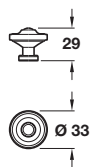

### ARIEL knob

- > 1 each of M4 x 22 mm and 27 mm handle screws included
- > \*Order fixing screws separately for polished chrome finish
- > Zinc alloy
- > Order qty: 1 pc

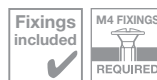

Finish	Cat. No.
Polished chrome	<b>134.06.200*</b>
Pewter effect	<b>166.11.900</b>



Don't forget to order M4 handle screws, see page **353**  
For our full range of fixing materials and installation tools see the Installation & Display section, pages **350-353**

# VIEW OUR COMPLETE HÄFELE DRESSCODE BEDROOM RANGE 24/7



Dresscode aluminium frame

Häfele Dresscode is an optimised wardrobe solution with stylish design. All components can be installed in an existing wardrobe or an easy to assemble aluminium frame system.

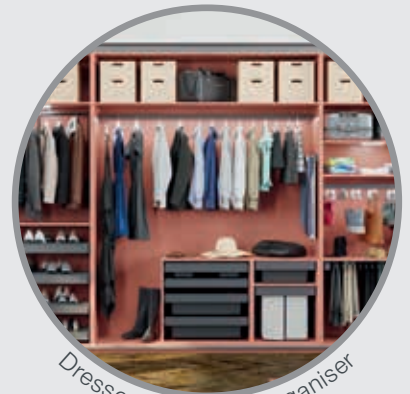

Dresscode cabinet organiser

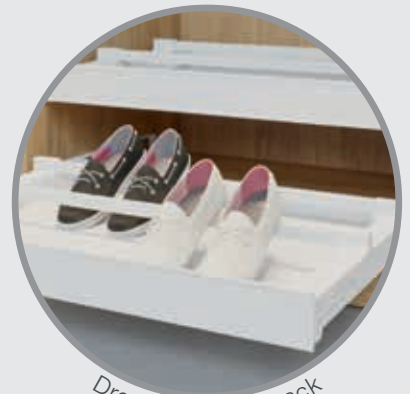

Dresscode shoe rack



Dresscode laundry bag

VISIT [HAFELE.CO.UK](https://www.hafele.co.uk) TO VIEW THE FULL RANGE

## Odessa

AT A GLANCE

KITCHEN APPLICATIONS

BEDROOM APPLICATIONS

BATHROOM APPLICATIONS

HANDLE FREE APPLICATIONS

INSTALLATION & DISPLAY

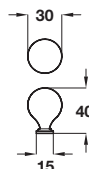
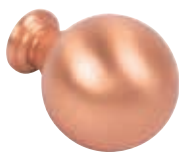
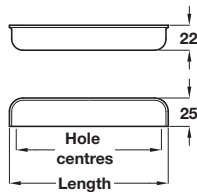

### ODESSA cup handle

- > Order M4 handle screws separately
- > Zinc alloy
- > Order qty: 1 pc



Finish	Length	Hole centres	Cat. No.
Polished chrome	78 mm	64 mm	<b>151.40.660</b>
	140 mm	128 mm	<b>151.40.665</b>
Stainless steel effect	78 mm	64 mm	<b>151.40.661</b>
	140 mm	128 mm	<b>151.40.666</b>
Brushed copper	78 mm	64 mm	<b>151.40.662</b>
	140 mm	128 mm	<b>151.40.667</b>

### ODESSA knob

- > Order M4 handle screws separately
- > Zinc alloy
- > Order qty: 1 pc



Finish	Cat. No.
Polished chrome	<b>110.35.360</b>
Stainless steel effect	<b>110.35.361</b>
Brushed copper	<b>110.35.362</b>

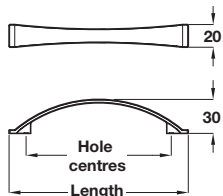

### ODESSA bow handle



- > Order M4 handle screws separately
- > Zinc alloy
- > Order qty: 1 pc



Finish	Length	Hole centres	Cat. No.
Polished chrome	158 mm	128 mm	<b>107.03.610</b>
Stainless steel effect			<b>107.03.611</b>
Brushed copper			<b>107.03.613</b>

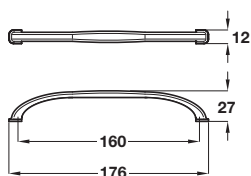

### ODESSA bow handle



- > Order M4 handle screws separately
- > Zinc alloy
- > Order qty: 1 pc



Finish	Cat. No.
Polished chrome	<b>107.03.615</b>
Stainless steel effect	<b>107.03.616</b>
Brushed copper	<b>107.03.617</b>



Don't forget to order M4 handle screws, see page **353**  
 For our full range of fixing materials and installation tools see the Installation & Display section, pages **350-353**

## Augusta

AT A GLANCE

KITCHEN APPLICATIONS

BEDROOM APPLICATIONS

BATHROOM APPLICATIONS

HANDLE FREE APPLICATIONS



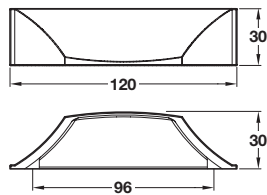

INSTALLATION & DISPLAY



### AUGUSTA cup handle

- > Order M4 handle screws separately
- > Zinc alloy
- > Order qty: 1 pc



Finish	Cat. No.
 Stainless steel effect	<b>118.68.104</b>
 Polished nickel	<b>118.68.704</b>
 Polished chrome	<b>118.68.204</b>
 Matt black	<b>118.68.804</b>
 Antique copper	<b>118.68.004</b>

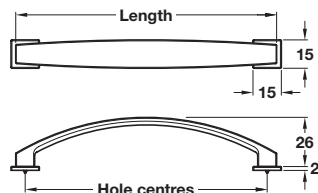

### AUGUSTA bow handle with backplates

- > Order M4 handle screws separately
- > Use with or without backplates
- > Zinc alloy
- > Order qty: 1 set



Finish	Length	Hole centres	Cat. No.
Stainless steel effect	138 mm	128 mm	<b>103.30.105</b>
	170 mm	160 mm	<b>103.30.106</b>
Polished nickel	138 mm	128 mm	<b>103.30.705</b>
	170 mm	160 mm	<b>103.30.706</b>
Polished chrome	138 mm	128 mm	<b>103.30.205</b>
	170 mm	160 mm	<b>103.30.206</b>
Matt black	138 mm	128 mm	<b>103.30.805</b>
	170 mm	160 mm	<b>103.30.806</b>
Antique copper	138 mm	128 mm	<b>103.30.005</b>
	170 mm	160 mm	<b>103.30.006</b>

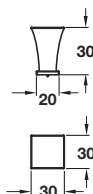
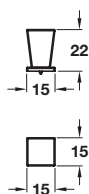

### AUGUSTA knob with backplate

- > Order M4 handle screws separately
- > Use with or without backplate
- > Zinc alloy
- > Order qty: 1 set



Finish	15 x 15 mm	30 x 30 mm
Stainless steel effect	<b>110.35.380</b>	<b>110.35.392</b>
Polished nickel	<b>110.35.381</b>	-
Polished chrome	<b>110.35.382</b>	<b>110.35.390</b>
Matt black	<b>110.35.384</b>	<b>110.35.393</b>
Antique copper	<b>110.35.383</b>	<b>110.35.394</b>



Don't forget to order M4 handle screws, see page **353**

For our full range of fixing materials and installation tools see the Installation & Display section, pages **350-353**

## Kane

AT A GLANCE

KITCHEN APPLICATIONS

BEDROOM APPLICATIONS

BATHROOM APPLICATIONS

HANDLE FREE APPLICATIONS

INSTALLATION & DISPLAY

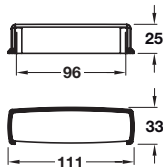

Product is subject to variations in finish due to the finishing and manufacturing process of certain materials

### KANE cup handle

- > 2x 8/32 x 1" (non-metric) screws included
- > Zinc alloy
- > Order qty: 1 pc



Finish	Cat. No.
 Oil rubbed bronze	<b>133.50.140</b>

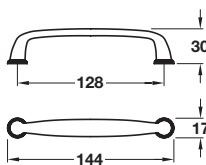

Product is subject to variations in finish due to the finishing and manufacturing process of certain materials

### KANE pull handle

- > 2x 8/32 x 1" (non-metric) screws included
- > Zinc alloy
- > Order qty: 1 pc



Finish	Cat. No.
 Oil rubbed bronze	<b>133.50.340</b>

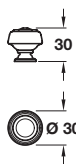

Product is subject to variations in finish due to the finishing and manufacturing process of certain materials

### KANE knob

- > 1x 8/32 x 1" (non-metric) screw included
- > Zinc alloy
- > Order qty: 1 pc



Finish	Cat. No.
 Oil rubbed bronze	<b>133.50.609</b>



All handles on this page include 8/32 x 1" (non-metric) screws. If you require a different length order non-metric cut off screw Cat. No. 022.24.881 shown on page **353**



# Crawford

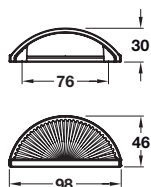

\*Product is subject to variations in finish due to the finishing and manufacturing process of certain materials

## CRAWFORD cup handle



- > 2x 8/32 x 1" (non-metric) screws included
- > Zinc alloy
- > Order qty: 1 pc



Finish	Cat. No.
Golden champagne	133.50.143
Oil rubbed bronze*	133.50.144

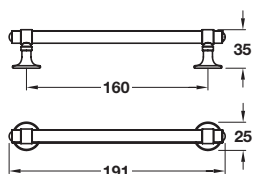

\*Product is subject to variations in finish due to the finishing and manufacturing process of certain materials

## CRAWFORD pull handle



- > 2x 8/32 x 1" (non-metric) screws included
- > Zinc alloy
- > Order qty: 1 pc



Finish	Cat. No.
Golden champagne	133.50.374
Oil rubbed bronze*	133.50.377

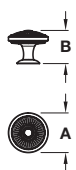

\*Product is subject to variations in finish due to the finishing and manufacturing process of certain materials

## CRAWFORD knob



- > 1x 8/32 x 1" (non-metric) screw included
- > Zinc alloy
- > Order qty: 1 pc



Finish	Dim. A	Dim. B	Cat. No.
Golden champagne	Ø 35 mm	30 mm	133.50.303
Oil rubbed bronze*	Ø 35 mm	30 mm	133.50.305

## Cotswold

AT A GLANCE

KITCHEN APPLICATIONS

BEDROOM APPLICATIONS

BATHROOM APPLICATIONS

HANDLE FREE APPLICATIONS

INSTALLATION & DISPLAY

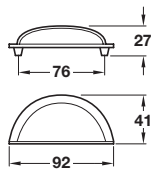

Note: ± 3 mm tolerance on non-critical dimensions and ±1 mm on hole centre dimensions  
Product is subject to variations in finish due to the finishing and manufacturing process of certain materials

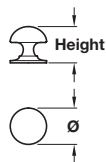

Note: ± 3 mm tolerance on non-critical dimensions and ±1 mm on hole centre dimensions  
Product is subject to variations in finish due to the finishing and manufacturing process of certain materials

### COTSWOLD cup handle

- > 2x M4 x 50 mm handle screws included
- > Brass
- > Order qty: 1 pc



Finish	Cat. No.
Polished nickel	151.07.701
Brushed copper	151.07.001

### COTSWOLD knob

- > 1x M4 x 50 mm handle screw included
- > Brass
- > Order qty: 1 pc



Finish	Diameter	Height	Cat. No.
Polished nickel	Ø 31 mm	32 mm	134.97.710
	Ø 38 mm	39 mm	134.97.711
Brushed copper	Ø 38 mm	39 mm	134.97.011



Brushed copper has not been lacquered and will change naturally over time



**COTSWOLD cup handle**

- > 3x Ø 3.5 x 20 mm raised head screws included
- > Brass
- > Order qty: 1 pc

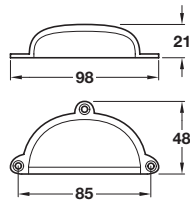

Note: ± 3 mm tolerance on non-critical dimensions and ±1 mm on hole centre dimensions

\*Product is subject to variations in finish due to the finishing and manufacturing process of certain materials

Finish	Cat. No.
Polished nickel	<b>166.08.700</b>
Bronzed and brushed*	<b>166.08.100</b>
Polished brass	<b>166.08.800</b>



**COTSWOLD knob**

- > 1x M4 x 50 mm snap off handle screw included
- > Brass
- > Order qty: 1 pc

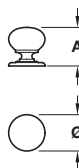

Note: ± 3 mm tolerance on non-critical dimensions

\*Product is subject to variations in finish due to the finishing and manufacturing process of certain materials

Finish	Diameter	Dim. A	Cat. No.
Polished nickel	Ø 31 mm	33 mm	<b>133.32.710</b>
	Ø 38 mm	36 mm	<b>133.32.711</b>
Bronzed and brushed*	Ø 33 mm	33 mm	<b>133.32.100</b>
Polished brass	Ø 33 mm	33 mm	<b>133.32.800</b>



**COTSWOLD drop handle**

- > 2x M4 spindle and nut included
- > Brass
- > Order qty: 1 pc

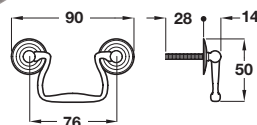

Note: ± 3 mm tolerance on non-critical dimensions and ±1 mm on hole centre dimensions

Product is subject to variations in finish due to the finishing and manufacturing process of certain materials

Finish	Cat. No.
Bronzed and brushed	<b>120.13.130</b>



Bronzed and brushed has not been lacquered and will change naturally over time

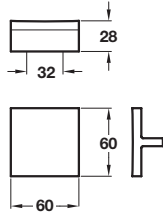

### AMBER knob

- > Order M4 handle screws separately
- > Zinc alloy
- > Order qty: 1 pc



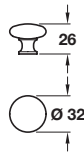

Finish	Cat. No.
 Polished chrome	<b>131.14.260</b>



### ORIEL knob

- > Order M4 handle screws separately
- > Zinc alloy
- > Order qty: 1 pc





Finish	Cat. No.
 Matt nickel	<b>134.02.600</b>
 Stainless steel effect	<b>135.24.600</b>
 Polished chrome	<b>133.09.200</b>



### GROSVENOR knob

- > Order M4 handle screws separately
- > Brass
- > Order qty: 1 pc



Finish	Diameter	Dim. A	Cat. No.
 Polished chrome	Ø 32 mm	28 mm	<b>137.00.224</b>
	Ø 38 mm	30 mm	<b>137.00.205</b>
 Polished brass	Ø 32 mm	28 mm	<b>137.00.822</b>
	Ø 38 mm	30 mm	<b>137.00.805</b>



Don't forget to order M4 handle screws, see page **353**  
For our full range of fixing materials and installation tools see the Installation & Display section, pages **350-353**

# VIEW OUR COMPLETE HÄFELE DRESSCODE BEDROOM RANGE 24/7



Dresscode aluminium frame

Häfele Dresscode is an optimised wardrobe solution with stylish design. All components can be installed in an existing wardrobe or an easy to assemble aluminium frame system.

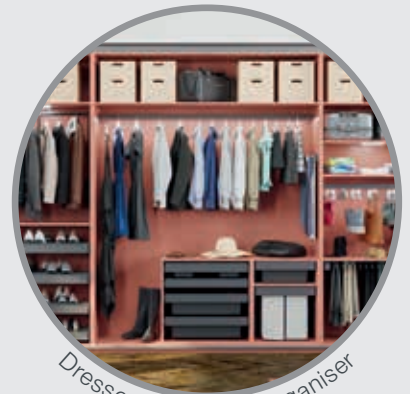

Dresscode cabinet organiser

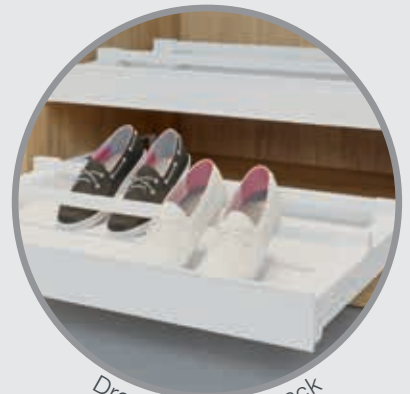

Dresscode shoe rack



Dresscode laundry bag

VISIT [HAFELE.CO.UK](https://www.hafele.co.uk) TO VIEW THE FULL RANGE

Rocher

AT A GLANCE

KITCHEN APPLICATIONS

BEDROOM APPLICATIONS

BATHROOM APPLICATIONS

HANDLE FREE APPLICATIONS

INSTALLATION & DISPLAY



Rocher knob Cat. No. 137.80.730 shown on round backplate Cat. No. 137.80.740

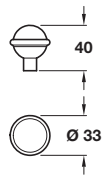

Note: ± 3 mm tolerance on non-critical dimensions

**ROCHER knob**

- > 1x M4 x 25 mm handle screw included
- > Brass
- > Order qty: 1 pc



Finish	Cat. No.
 Polished nickel	<b>137.80.730</b>



➔ BALLEY and SULA knobs shown on page 164 also available



### Round backplate



- > Order M4 handle screw separately
- > Brass
- > Order qty: 1 pc

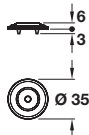

Note: ± 3 mm tolerance on non-critical dimensions

Finish	Cat. No.
 Polished nickel	<b>137.80.740</b>



### Square backplate



- > Order M4 handle screw separately
- > Brass
- > Order qty: 1 pc

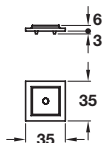

Note: ± 3 mm tolerance on non-critical dimensions

Finish	Cat. No.
 Polished nickel	<b>137.80.750</b>



### Rectangular backplate



- > Order M4 handle screw separately
- > Brass
- > Order qty: 1 pc

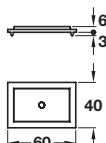

Note: ± 3 mm tolerance on non-critical dimensions

Finish	Cat. No.
 Polished nickel	<b>137.80.760</b>

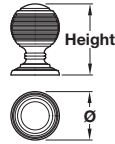

Note: ± 3 mm tolerance on non-critical dimensions and ±1 mm on hole centre dimensions

### JUPITER knob

- > 1x M4 x 25 mm handle screw included
- > Brass
- > Order qty: 1 pc



Finish	Diameter	Height	Cat. No.
Stainless steel effect	Ø 32 mm	44 mm	<b>123.02.080</b>
	Ø 38 mm	52 mm	<b>135.07.610</b>

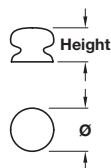

### VICTORIA knob

- > Order M4 handle screws separately
- > Ceramic
- > Order qty: 1 pc



Finish	Diameter	Dim. A	Cat. No.
White	Ø 38 mm	30 mm	<b>130.48.701</b>
Magnolia	Ø 38 mm	30 mm	<b>130.48.407</b>
Black	Ø 38 mm	30 mm	<b>130.48.309</b>
	Ø 50 mm	39 mm	<b>130.48.302</b>



# Timber Grain Knobs

Timber knobs are available in two versions, routed cross grain and turned end grain. Routed knobs have the cross grain on top, like you have on a wooden front. Turned knobs have the end grain on top of the knob



### Cross grain knobs -

Individually routed from a fixed wooden block with a full shaped tool. Each knob is then sanded to the final shape. This method of manufacture makes for a higher quality knob that shows the natural wood grain to it's best

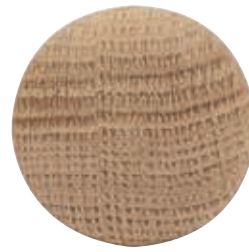

### End grain knobs -

Traditional turned knobs are turned on a copy lathe from a long turning wood dowel and cut off automatically. This method of manufacture is faster and produces a more economical and cost effective product



Oak, unfinished



Beech, unfinished

### Turned knob, end grain

- > Order M4 handle screws separately
- > Wood, unfinished
- > Order qty: 1 pc



Product is subject to variations in colour and dimensions due to being manufactured from natural materials

Finish	Diameter	Dim. A	Cat. No.
Oak	Ø 34 mm	28 mm	<b>195.75.401</b>
	Ø 44 mm	38 mm	<b>195.75.403</b>
Beech	Ø 34 mm	28 mm	<b>195.75.301</b>
	Ø 44 mm	38 mm	<b>195.75.302</b>



Don't forget to order M4 handle screws, see page **353**  
For our full range of fixing materials and installation tools see the Installation & Display section, pages **350-353**

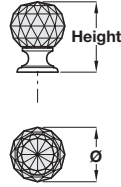

### HARLEY knob

- > 1x M4 x 22 mm and 1x M4 x 25 mm handle screws included
- > Glass knob with brass base
- > Order qty: 1 pc



Finish	Length	Height	Cat. No.
	Ø 30 mm	41 mm	<b>139.60.422</b>
	Ø 35 mm	45 mm	<b>139.60.423</b>

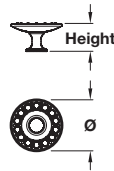

### DIAMOND knob

- > Order M4 handle screws separately
- > Zinc alloy with Swarovski crystal
- > Order qty: 1 pc



Finish	Length	Height	Cat. No.
	Ø 45 mm	27 mm	<b>132.19.270</b>

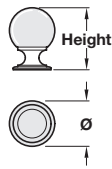

### PRIMROSE knob

- > Order M4 handle screws separately
- > Zinc alloy with glass knob
- > Order qty: 1 pc



Finish	Length	Height	Cat. No.
	Ø 25 mm	36 mm	<b>139.60.400</b>
	Ø 30 mm	41 mm	<b>139.60.401</b>

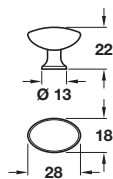

### PEARL knob

- > Order M4 handle screws separately
- > Zinc alloy
- > Order qty: 1 pc



Finish	Cat. No.
	<b>133.09.210</b>
	<b>133.09.410</b>
	<b>133.09.010</b>



# Como

AT A GLANCE

KITCHEN APPLICATIONS

BEDROOM APPLICATIONS

BATHROOM APPLICATIONS

HANDLE FREE APPLICATIONS

INSTALLATION & DISPLAY

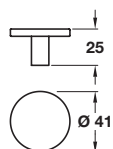

### COMO knob

- > 1x M4 x 25 mm handle screw included
- > Zinc alloy
- > Order qty: 1 pc



Finish	Cat. No.
 Matt black	<b>106.66.287</b>
 Brushed nickel	<b>106.66.285</b>
 Brushed gold	<b>106.66.284</b>
 Brushed copper	<b>106.66.286</b>



➔ The ESTE pull handle shown on page **231** matches the COMO knob

⊕ View the full Aspekt cabinet doors range, visit [www.hafele.co.uk/aspekt-doors](http://www.hafele.co.uk/aspekt-doors)

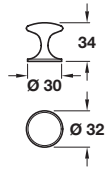



\*Product is subject to variations in finish due to the finishing and manufacturing process of certain materials

### CHLOEU knob

- > Order M4 handle screws separately
- > Brass
- > Order qty: 1 pc



Finish	Cat. No.
 Brushed brass*	123.03.500
 Polished nickel	123.03.700

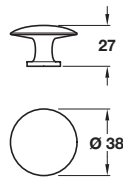



Note: ± 3 mm tolerance on non-critical dimensions

### KEW knob

- > 1x M4 x 25 mm handle screw included
- > Brass
- > Order qty: 1 pc



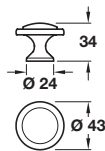

Finish	Cat. No.
 Polished chrome	134.97.482
 Stainless steel effect	134.97.083



### CONSTANCE knob

- > Order M4 handle screws separately
- > Zinc alloy
- > Order qty: 1 pc



Finish	Cat. No.
 Polished chrome	134.45.220
 Stainless steel effect	134.45.620



Don't forget to order M4 handle screws, see page **353**  
For our full range of fixing materials and installation tools see the Installation & Display section, pages **350-353**

# Oberon



AT A GLANCE

KITCHEN APPLICATIONS

BEDROOM APPLICATIONS

BATHROOM APPLICATIONS

HANDLE FREE APPLICATIONS

INSTALLATION & DISPLAY

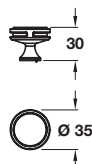

FURNITURE HANDLES 2021, © Häfele U.K. Ltd 2021. Dimensional data not binding. We reserve the right to alter specifications without notice.



### OBERON knob

- > 1x 8/32 x 1" (non-metric) screw included
- > Zinc alloy
- > Order qty: 1 pc



Finish	Cat. No.
 Golden champagne	<b>133.50.618</b>
 Polished nickel	<b>133.50.622</b>



All handles on this page include 8/32 x 1" (non-metric) screws. If you require a different length order non-metric cut off screw Cat. No. 022.24.881 shown on page **353**

## Twister

AT A GLANCE

KITCHEN APPLICATIONS

BEDROOM APPLICATIONS

BATHROOM APPLICATIONS

HANDLE FREE APPLICATIONS

INSTALLATION & DISPLAY



FURNITURE HANDLES 2021, © Häfele U.K. Ltd 2021. Dimensional data not binding. We reserve the right to alter specifications without notice.

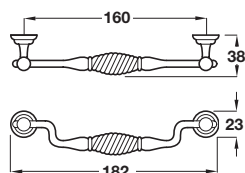

### TWISTER drop handle

- > 2x M4 x 26 mm handle screw included
- > Zinc alloy
- > Order qty: 1 pc



Finish	Cat. No.
Antique pewter	119.20.921

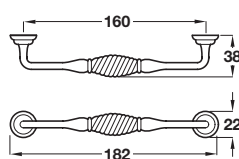

### TWISTER D handle

- > 2x M4 x 26 mm handle screw included
- > Zinc alloy
- > Order qty: 1 pc



Finish	Cat. No.
Antique pewter	119.20.910

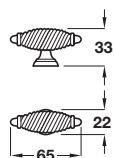

### TWISTER pull handle

- > 1x M4 x 26 mm handle screw included
- > Zinc alloy
- > Order qty: 1 pc



Finish	Cat. No.
Antique pewter	119.20.900

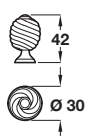

### TWISTER knob

- > 1x M4 x 26 mm handle screw included
- > Zinc alloy
- > Order qty: 1 pc



Finish	Cat. No.
Antique pewter	119.21.900

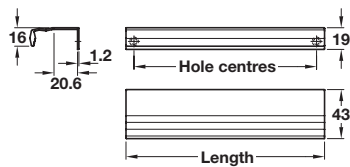
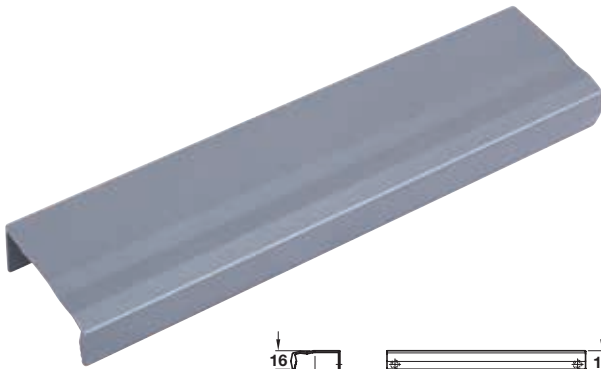

### LINE profile handle

- > Order M4 handle screws separately
- > Aluminium
- > Order qty: 1 pc



Finish	Length	Hole centres	Cat. No.
Matt anthracite	78 mm	64 mm	<b>111.71.510</b>
	174 mm	160 mm	<b>111.71.511</b>
	334 mm	320 mm	<b>111.71.512</b>

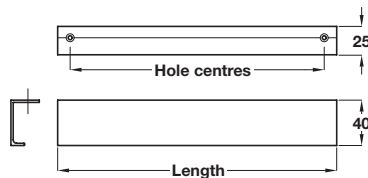
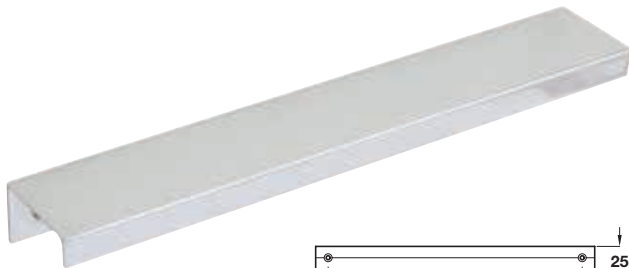

### LISTER trim handle

- > Order screws separately
- > Aluminium
- > Order qty: 1 pc



Finish	Length	Hole centres	Cat. No.
Brushed nickel	147 mm	128 mm	<b>126.17.641</b>
	297 mm	256 mm	<b>126.17.642</b>

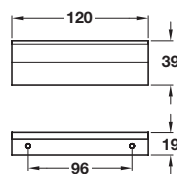

### RUBY trim handle

- > 2x Ø 3.0 x 13 mm countersunk head screws included
- > Brass
- > Order qty: 1 pc



Finish	Cat. No.
Brushed copper	<b>112.84.024</b>
Polished nickel	<b>112.84.724</b>

Note: ± 3 mm tolerance on non-critical dimensions and ±1 mm on hole centre dimensions



# Libra

AT A GLANCE

KITCHEN APPLICATIONS

BEDROOM APPLICATIONS

BATHROOM APPLICATIONS

HANDLE FREE APPLICATIONS

INSTALLATION & DISPLAY

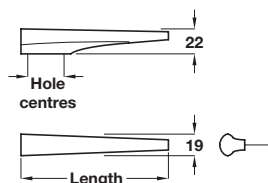

### LIBRA pull handle

- > 2x M4 x 25 mm handle screws included
- > Zinc alloy
- > Order qty: 1 pc



Finish	Length	Hole centres	Cat. No.
Polished chrome	130 mm	32 mm	<b>107.03.200</b>
	210 mm	32/64 mm	<b>107.03.201</b>
	280 mm	64/96 mm	<b>107.03.202</b>



## Angle

AT A GLANCE

KITCHEN APPLICATIONS

BEDROOM APPLICATIONS

BATHROOM APPLICATIONS

HANDLE FREE APPLICATIONS

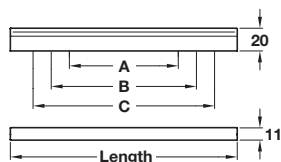

INSTALLATION & DISPLAY



### ANGLE pull handle

- > 2x M4 x 25 mm handle screws included
- > Aluminium
- > Order qty: 1 pc



Finish	Length	Hole centres			Cat. No.
		A	B	C	
 Polished chrome	200 mm	96 mm	128 mm	160 mm	<b>108.66.230</b>
	400 mm	256 mm	320 mm	-	<b>108.66.231</b>
	500 mm	416 mm	320 mm	-	<b>108.66.232</b>
	900 mm	640 mm	-	-	<b>108.66.234</b>
 Matt black	200 mm	128 mm	160 mm	-	<b>108.66.330</b>
 Stainless steel effect	200 mm	96 mm	128 mm	160 mm	<b>108.66.030</b>

# VIEW OUR COMPLETE HÄFELE DRESSCODE BEDROOM RANGE 24/7



Dresscode aluminium frame

Häfele Dresscode is an optimised wardrobe solution with stylish design. All components can be installed in an existing wardrobe or an easy to assemble aluminium frame system.

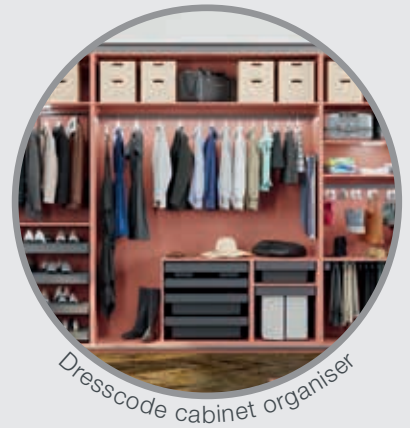

Dresscode cabinet organiser

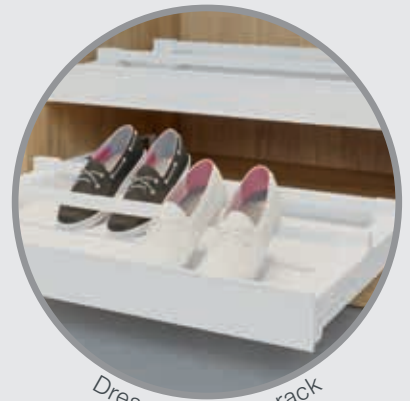

Dresscode shoe rack



Dresscode laundry bag

VISIT [HAFELE.CO.UK](https://www.hafele.co.uk) TO VIEW THE FULL RANGE

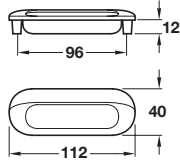

### RHIN Inset handle

- > Order M4 handle screws separately
- > Zinc alloy
- > Order qty: 1 pc



Finish	Cat. No.
Polished chrome / Aluminium coloured inside	<b>151.17.209</b>

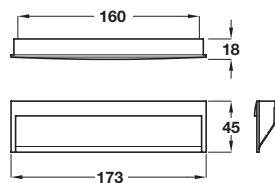
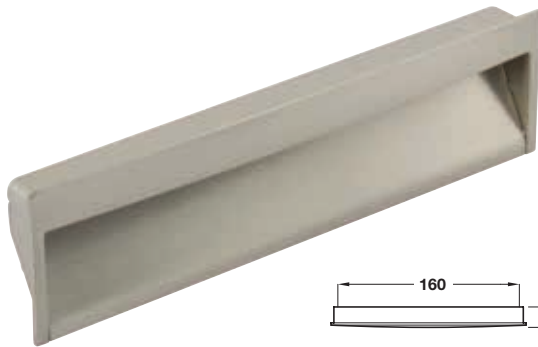

### CAVENDISH inset handle

- > 2x M4 x 25 mm handle screws included
- > Zinc alloy
- > Order qty: 1 pc



Finish	Cat. No.
Stainless steel effect	<b>151.11.613</b>

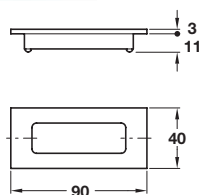

### MAINE inset handle

- > Concealed fixing
- > 2x Ø 3.5 x 20 mm screws included
- > Brass
- > Order qty: 1 pc



Finish	Cat. No.
Stainless steel effect	<b>151.73.601</b>

# Cubic



Matt white finish shown on both gloss dark grey or dark wood doors



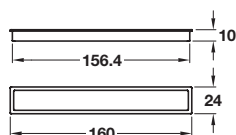

Matt black finish shown on both gloss dark grey or dark wood doors



## CUBIC inset handle

- > Press-in fixing
- > Zinc alloy
- > Order qty: 1 pc



Finish	Cat. No.
 Matt white	151.11.640
 Matt black	151.11.641

## Bartram

AT A GLANCE

KITCHEN APPLICATIONS

BEDROOM APPLICATIONS

BATHROOM APPLICATIONS

HANDLE FREE APPLICATIONS

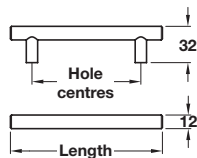

INSTALLATION & DISPLAY



### BARTRAM bar handle

- > \*2x M4 x 20 mm, 2x M4 x 22 mm and 2x M4 x 25 mm screws included
- > Steel
- > Order qty: 1 pc



Finish	Length	Hole centres	Cat. No.
 Antique copper	178 mm	128 mm	<b>117.97.062</b>
	220 mm	160 mm	<b>117.97.063*</b>
 Brushed oil rubbed bronze	178 mm	128 mm	<b>117.97.162</b>
	220 mm	160 mm	<b>117.97.163</b>



Don't forget to order M4 handle screws, see page **353**  
 For our full range of fixing materials and installation tools see the Installation & Display section, pages **350-353**

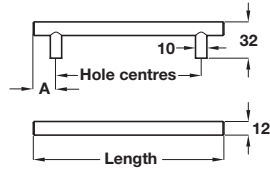

### BARKSTON bar handle, Ø 12 mm

- > \*2 each of M4 x 45 mm snap off handle screws included (101.20.700 includes an additional 1x M4 x 25 mm screw)
- > Order M4 handle screws separately
- > Steel
- > Order qty: 1 pc



Finish	Length	Hole centres	Dim. A	Cat. No.
Stainless steel effect	136 mm	96 mm	20 mm	<b>101.20.709</b>
	168 mm	128 mm	20 mm	<b>101.20.700*</b>
	226 mm	156 mm	35 mm	<b>101.20.701*</b>
	230 mm	160 mm	35 mm	<b>101.20.710*</b>
	232 mm	192 mm	20 mm	<b>101.20.708</b>
	326 mm	256 mm	35 mm	<b>101.20.702*</b>
	376 mm	306 mm	35 mm	<b>101.20.703*</b>
	426 mm	356 mm	35 mm	<b>101.20.704</b>
	526 mm	456 mm	35 mm	<b>101.20.705</b>
	702 mm	632 mm	35 mm	<b>101.20.706</b>
828 mm	758 mm	35 mm	<b>101.20.707*</b>	

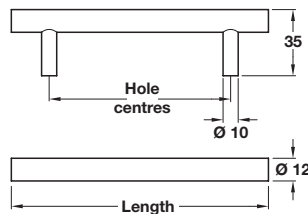

### BELLA bar handle, Ø 12 mm

- > Order M4 handle screws separately
- > Steel
- > Order qty: 1 pc



Finish	Length	Hole centres	Cat. No.
Polished chrome	136 mm	96 mm	<b>117.97.224</b>
	168 mm	128 mm	<b>117.97.225</b>
	200 mm	160 mm	<b>117.97.218</b>
	232 mm	192 mm	<b>117.97.227</b>
	328 mm	288 mm	<b>117.97.219</b>
	392 mm	352 mm	<b>117.97.229</b>

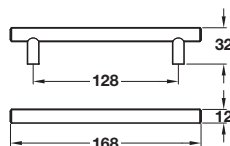

### PUMA bar handle

- > Order M4 handle screws separately
- > Steel
- > Order qty: 1 pc



Finish	Cat. No.
Matt black epoxy	<b>101.20.325</b>

## Tiberius

AT A GLANCE

KITCHEN APPLICATIONS

BEDROOM APPLICATIONS

BATHROOM APPLICATIONS

HANDLE FREE APPLICATIONS

INSTALLATION & DISPLAY

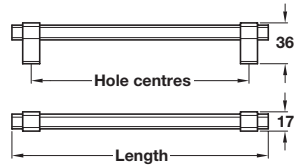

### TIBERIUS bar handle

- > 2x M4 x 25 mm handle screws included
- > Aluminium
- > Order qty: 1 pc



Finish	Length	Hole centres	Cat. No.
Polished chrome	163 mm	128 mm	<b>112.85.050</b>
	227 mm	192 mm	<b>112.85.051</b>
Black nickel	195 mm	160 mm	<b>112.85.071</b>

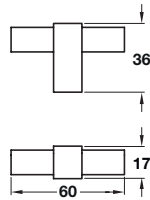

### TIBERIUS T knob

- > 1x M4 x 25 mm handle screw included
- > Aluminium
- > Order qty: 1 pc



Finish	Cat. No.
Black nickel	<b>112.85.095</b>



# Carrione



## CARRIONE pull handle

- > 2x 8/32 x 1" (non-metric) screws included
- > Zinc alloy
- > Order qty: 1 pc

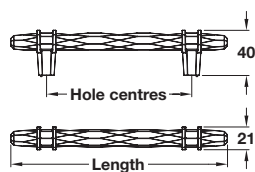

\*Product is subject to variations in finish due to the finishing and manufacturing process of certain materials

Finish	Length	Hole centres	Cat. No.
Marble white / Polished nickel	160 mm	96 mm	<b>133.53.035</b>
	191 mm	128 mm	<b>133.53.036</b>
Marble white / Oil rubbed bronze*	160 mm	96 mm	<b>133.53.037</b>
	191 mm	128 mm	<b>133.53.038</b>



## CARRIONE T knob

- > 1x 8/32 x 1" (non-metric) screw included
- > Zinc alloy
- > Order qty: 1 pc

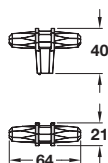

\*Product is subject to variations in finish due to the finishing and manufacturing process of certain materials

Finish	Cat. No.
Marble white / Polished nickel	<b>133.53.033</b>
Marble white / Oil rubbed bronze*	<b>133.53.034</b>

➔ All handles on this page include 8/32 x 1" (non-metric) screws. If you require a different length order non-metric cut off screw Cat. No. 022.24.881 shown on page **353**

## St. Vincent

AT A GLANCE

KITCHEN APPLICATIONS

BEDROOM APPLICATIONS

BATHROOM APPLICATIONS

HANDLE FREE APPLICATIONS

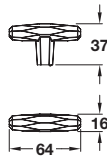
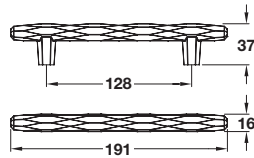

INSTALLATION & DISPLAY



### ST. VINCENT pull handle

- > 2x 8/32 x 1" (non-metric) screws included
- > Zinc alloy
- > Order qty: 1 pc





Finish	Cat. No.
 Polished nickel	<b>133.50.388</b>
 Golden champagne	<b>133.50.382</b>

### ST. VINCENT T knob

- > 1x 8/32 x 1" (non-metric) screw included
- > Zinc alloy
- > Order qty: 1 pc



Finish	Cat. No.
 Polished nickel	<b>133.50.641</b>
 Golden champagne	<b>133.50.639</b>



All handles on this page include 8/32 x 1" (non-metric) screws. If you require a different length order non-metric cut off screw Cat. No. 022.24.881 shown on page **353**

# Boston

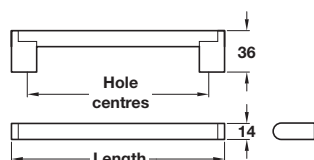

## BOSTON boss bar handle

- > Order M4 handle screws separately
- > \*2x M4 x 25 mm, 2x M4 x 25 mm and 2x M4 x 28 mm screws included
- > Zinc alloy ends, with hollow stainless steel tube or solid steel bar
- > Order qty: 1 pc



Finish	Length	Hole centres	Cat. No.
Stainless steel effect	<b>Hollow stainless steel tube</b>		
	156 mm	128 mm	<b>115.69.002</b>
	188 mm	160 mm	<b>115.69.003*</b>
	220 mm	192 mm	<b>115.69.004</b>
	237 mm	209 mm	<b>104.74.011</b>
	284 mm	256 mm	<b>115.69.006</b>
	337 mm	309 mm	<b>104.74.012</b>
	348 mm	320 mm	<b>115.69.008</b>
	387 mm	359 mm	<b>104.74.013</b>
	437 mm	409 mm	<b>104.74.014</b>
	476 mm	448 mm	<b>115.69.009</b>
	537 mm	509 mm	<b>104.74.015</b>
	<b>Solid steel bar</b>		
	751 mm	709 mm	<b>104.74.016</b>
849 mm	807 mm	<b>104.74.017</b>	
951 mm	909 mm	<b>104.74.018</b>	
1199 mm	1157 mm	<b>104.74.019</b>	

## Osaka

AT A GLANCE

KITCHEN APPLICATIONS

BEDROOM APPLICATIONS

BATHROOM APPLICATIONS

HANDLE FREE APPLICATIONS

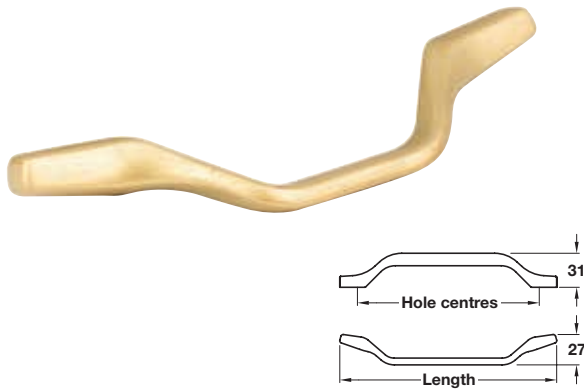

INSTALLATION & DISPLAY



### OSAKA pull handle

- > Fixings included:
  - Satin brass - 2x M4 x 50 mm snap-off handle screws
  - Antique copper and graphite - 2 each of M4 x 22 mm and M4 x 26 mm handle screws
- > Zinc alloy
- > Order qty: 1 pc



Finish	Length	Hole centres	Cat. No.
 Satin brass	127 mm	96 mm	<b>110.22.080</b>
	191 mm	160 mm	<b>110.22.081</b>
 Antique copper	191 mm	160 mm	<b>110.22.086</b>
	351 mm	320 mm	<b>110.22.089</b>
 Graphite	191 mm	160 mm	<b>110.22.586</b>

# VIEW OUR COMPLETE ACCESSIBLE BATHROOMS RANGE 24/7

With our extensive range of bathroom fittings and accessories, Häfele can fulfil any accessible bathroom fitting requirements across both commercial and residential landscapes.

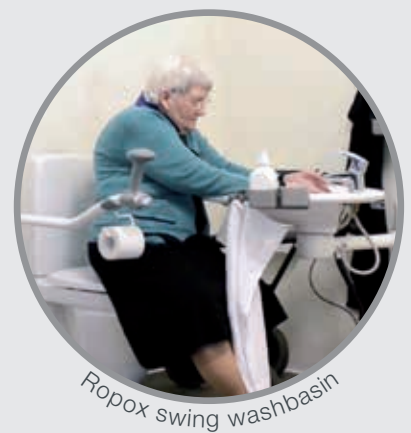

VISIT [HAFELE.CO.UK](http://HAFELE.CO.UK) TO VIEW THE FULL RANGE

## Metropolis

The Metropolis range includes pull handles, bar handles and knobs in satin stainless steel



AT A GLANCE

KITCHEN APPLICATIONS

BEDROOM APPLICATIONS

BATHROOM APPLICATIONS

HANDLE FREE APPLICATIONS

INSTALLATION & DISPLAY

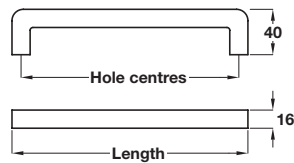

### METROPOLIS pull handle

- > 2x M4 x 25 mm handle screws included
- > Grade 304 stainless steel
- > Order qty: 1 pc



Finish	Length	Hole centres	Cat. No.
Satin stainless steel	208 mm	192 mm	<b>115.62.004</b>
	336 mm	320 mm	<b>115.62.008</b>
	464 mm	448 mm	<b>115.62.011</b>

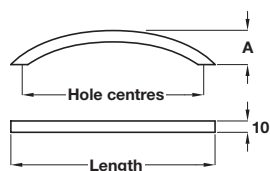

### METROPOLIS bow handle

- > 2x M4 x 25 mm handle screws included
- > Grade 304 stainless steel
- > Order qty: 1 pc



Finish	Length	Hole centres	Dim. A	Cat. No.
Satin stainless steel	181 mm	160 mm	31 mm	<b>100.55.003</b>
	259 mm	224 mm	32 mm	<b>100.55.005</b>
	365 mm	320 mm	33 mm	<b>100.55.008</b>



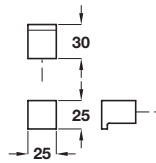

### METROPOLIS knob

EXCLUSIVE TO HÄFELE

- > 1x M4 x 25 mm handle screw included
- > Grade 303 stainless steel
- > Order qty: 1 pc



Finish	Size	Height	Cat. No.
Satin stainless steel	25 mm	30 mm	<b>132.94.010</b>



### METROPOLIS knob

EXCLUSIVE TO HÄFELE

- > 1x M4 x 25 mm handle screw included
- > Grade 303 stainless steel
- > Order qty: 1 pc



Finish	Diameter	Height	Cat. No.
Satin stainless steel	Ø 32 mm	30 mm	<b>134.28.010</b>
	Ø 38 mm	30 mm	<b>132.94.040</b>
	Ø 60 mm	35 mm	<b>134.28.011</b>

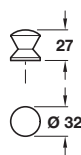

### METROPOLIS knob

EXCLUSIVE TO HÄFELE

- > 1x M4 x 25 mm handle screw included
- > Grade 303 stainless steel
- > Order qty: 1 pc



Finish	Diameter	Height	Cat. No.
Satin stainless steel	Ø 32 mm	27 mm	<b>134.28.020</b>



Knob



Backplate

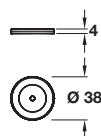
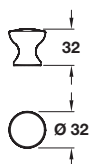

### METROPOLIS knob and backplate

EXCLUSIVE TO HÄFELE

- > 1x M4 x 25 mm handle screw included
- > Grade 303 stainless steel
- > Order qty: 1 pc



Finish	Item	Cat. No.
Satin stainless steel	Knob	<b>132.94.030</b>
	Backplate	<b>132.94.090</b>

**+** Use with or without backplate. Order backplate separately

## Oasi

AT A GLANCE

KITCHEN APPLICATIONS

BEDROOM APPLICATIONS

BATHROOM APPLICATIONS

HANDLE FREE APPLICATIONS

INSTALLATION & DISPLAY

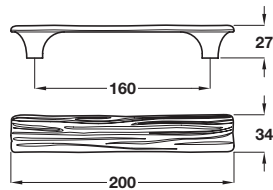

### OASI bar handle

- > Order M4 handle screws separately
- > Zinc alloy
- > Order qty: 1 pc



Finish	Cat. No.
 Polished chrome	116.60.213



### OASI knob

- > Order M4 handle screws separately
- > Zinc alloy
- > Order qty: 1 pc



Finish	Cat. No.
 Polished chrome	131.27.260



Don't forget to order M4 handle screws, see page **353**  
For our full range of fixing materials and installation tools see the Installation & Display section, pages **350-353**



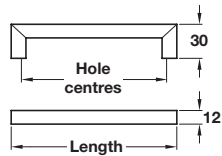

### BALTIMORE D handle

- > Order M4 handle screws separately
- > Zinc alloy
- > Order qty: 1 pc



Finish	Length	Hole centres	Cat. No.
Polished chrome	114 mm	96 mm	<b>102.12.201</b>
	146 mm	128 mm	<b>102.12.202</b>

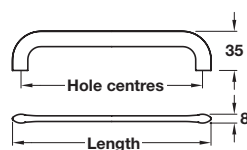
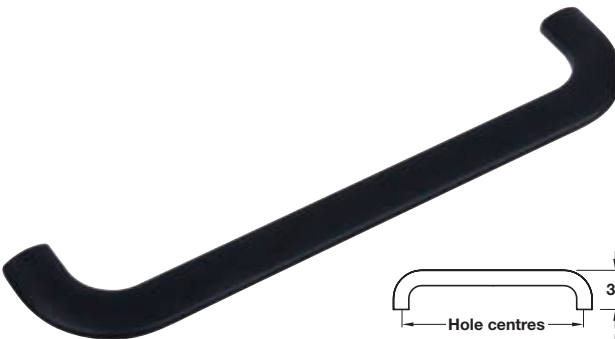
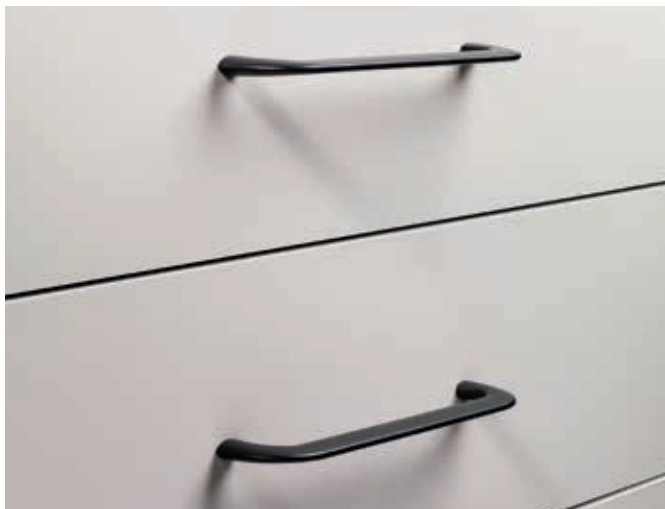

### CURLY D handle

- > Order M4 handle screws separately
- > Zinc alloy
- > Order qty: 1 pc



Finish	Length	Hole centres	Cat. No.
Matt black	79 mm	64 mm	<b>111.71.010</b>
	175 mm	160 mm	<b>111.71.011</b>
	335 mm	320 mm	<b>111.71.012</b>

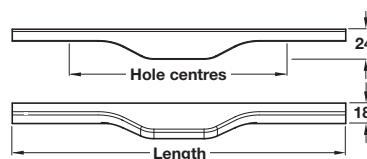
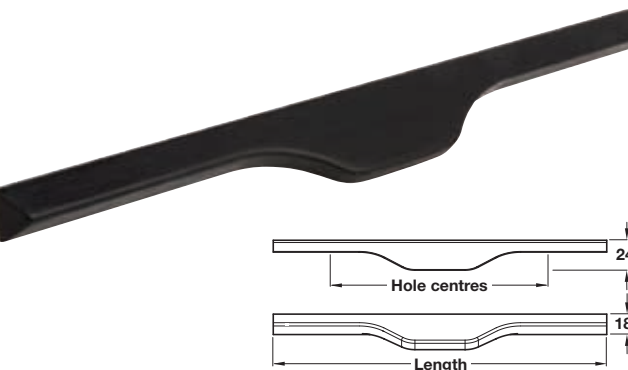

### ULTRA pull handle

- > Order M4 handle screws separately
- > Ash
- > Order qty: 1 pc



Finish	Length	Hole centres	Cat. No.
Oak lacquered	294 mm	192 mm	<b>193.18.417</b>
	394 mm	256 mm	<b>193.18.418</b>
	594 mm	160/480 mm	<b>193.18.419</b>



Product is subject to variations in colour and dimensions due to being manufactured from natural materials

## Graf & Graf 2

AT A GLANCE

KITCHEN APPLICATIONS

BEDROOM APPLICATIONS

BATHROOM APPLICATIONS

HANDLE FREE APPLICATIONS

INSTALLATION & DISPLAY

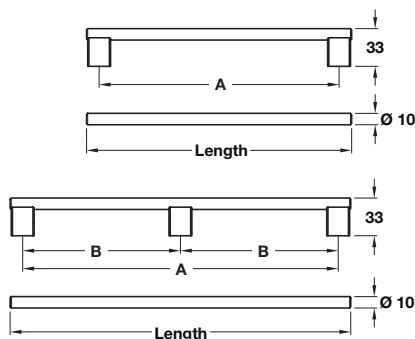
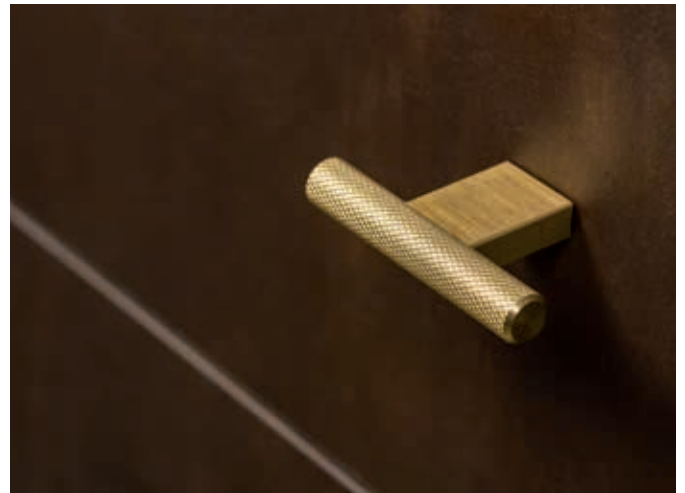
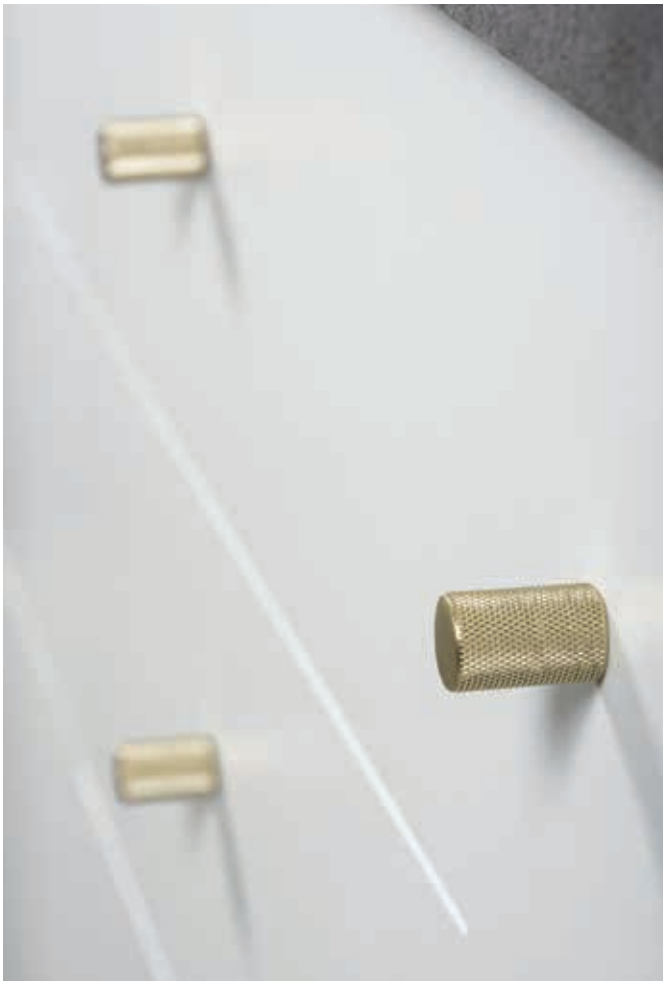

### GRAF 2 bar handle

- > 2/3x M4 x 25 mm handle screws included
- > Aluminium
- > Order qty: 1 pc



Finish	Length	Hole centres		Cat. No.
		A	B	
Stainless steel effect	182 mm	160 mm	-	<b>132.19.110</b>
	278 mm	256 mm	-	<b>132.19.111</b>
	1200 mm	1178 mm	589 mm	<b>132.19.112</b>
Black	182 mm	160 mm	-	<b>132.19.115</b>
	278 mm	256 mm	-	<b>132.19.116</b>
	1200 mm	1178 mm	589 mm	<b>132.19.117</b>
Brushed dark brass	182 mm	160 mm	-	<b>132.19.120</b>
	278 mm	256 mm	-	<b>132.19.121</b>
	1200 mm	1178 mm	589 mm	<b>132.19.122</b>

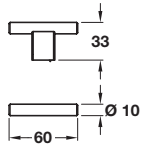

### GRAF 2 T knob

- > 1x M4 x 25 mm handle screw included
- > Aluminium
- > Order qty: 1 pc



Finish	Cat. No.
Stainless steel effect	132.19.105
Black	132.19.106
Brushed dark brass	132.19.107

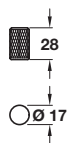

### GRAF knob

- > 1x M4 x 25 mm handle screw included
- > Aluminium
- > Order qty: 1 pc



Finish	Cat. No.
Polished chrome	132.15.230
Brushed brass	132.19.210
Matt black	132.19.211
Stainless steel effect	132.15.630
Brushed dark brass	106.60.318

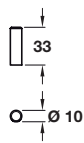

### GRAF 2 cylindrical knob

- > 1x M4 x 25 mm handle screw included
- > Aluminium
- > Order qty: 1 pc



Finish	Cat. No.
Stainless steel effect	132.19.100
Black	132.19.101
Brushed dark brass	132.19.102

## Graf Big

AT A GLANCE

KITCHEN APPLICATIONS

BEDROOM APPLICATIONS

BATHROOM APPLICATIONS

HANDLE FREE APPLICATIONS

INSTALLATION & DISPLAY

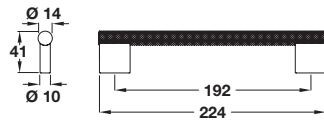

### GRAF BIG bar handle

- > 2x M4 x 25 mm handle screws included
- > Aluminium
- > Order qty: 1 pc



Finish	Cat. No.
Stainless steel effect	106.66.112
Brushed black	106.66.110
Brushed dark brass	106.66.111



### GRAF BIG knob

- > 1x M4 x 25 mm handle screw included
- > Aluminium
- > Order qty: 1 pc



Finish	Ø 38 mm	Ø 50 mm
Stainless steel effect	106.66.102	106.66.105
Brushed black	106.66.100	106.66.103
Dark brass	106.66.101	106.66.104

# Tarvos, Encanto & Rhea

The Tarvos, Encanto and Rhea are textured furniture handles in a graphite finish with three designs of bar handles to choose from. Use to contrast or coordinate, the textured finish gives added style and makes the handle a pleasure to use

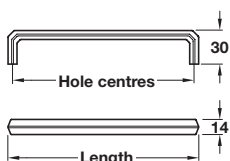

### TARVOS pull handle

- > 2x M4 x 22 mm handles screws included
- > Zinc alloy
- > Order qty: 1 pc



Finish	Length	Hole centres	Cat. No.
Matt black	136 mm	128 mm	<b>113.96.120</b>
	168 mm	160 mm	<b>113.96.121</b>

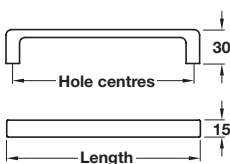

### ENCANTO pull handle

- > 2x M4 x 22 mm handles screws included
- > Zinc alloy
- > Order qty: 1 pc



Finish	Length	Hole centres	Cat. No.
Matt black	172 mm	160 mm	<b>113.96.100</b>
	332 mm	320 mm	<b>113.96.101</b>

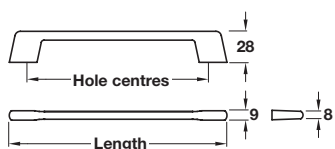

### RHEA pull handle

- > 2x M4 x 22 mm handles screws included
- > Zinc alloy
- > Order qty: 1 pc



Finish	Length	Hole centres	Cat. No.
Matt black	153 mm	128 mm	<b>113.96.110</b>
	185 mm	160 mm	<b>113.96.111</b>

## U

AT A GLANCE

KITCHEN APPLICATIONS

BEDROOM APPLICATIONS

BATHROOM APPLICATIONS

HANDLE FREE APPLICATIONS

INSTALLATION & DISPLAY

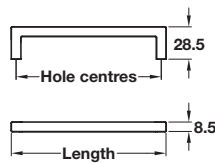
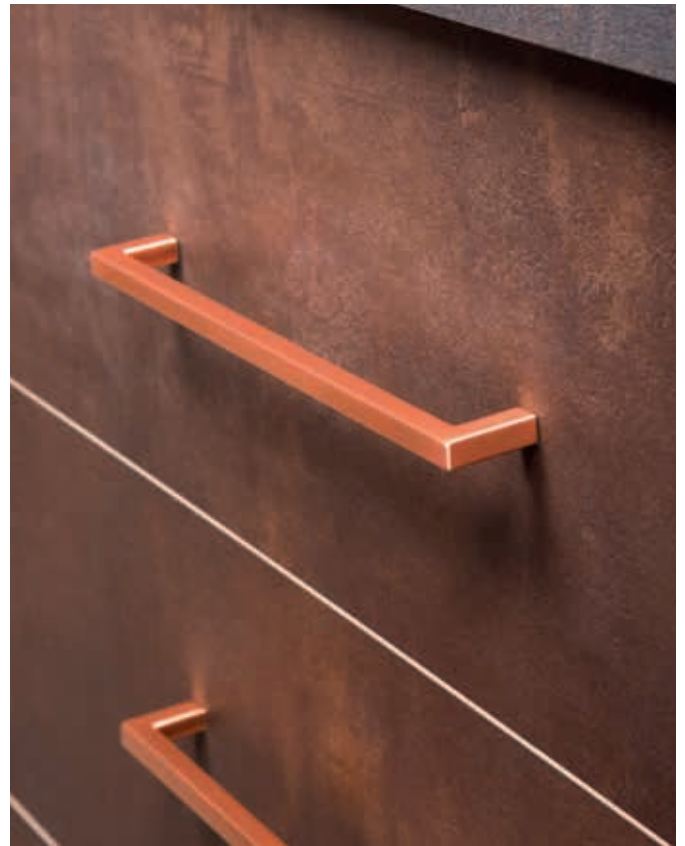

### U pull handle

- > 2x M4 x 25 mm handle screws included
- > Zinc alloy
- > Order qty: 1 pc



Finish	Length	Hole centres	Cat. No.
 Matt black	136.5 mm	128 mm	<b>108.66.385</b>
	200.5 mm	192 mm	<b>108.66.397</b>
	328.5 mm	320 mm	<b>108.66.386</b>
	500.5 mm	492 mm	<b>108.66.387</b>
 Polished chrome	136.5 mm	128 mm	<b>108.66.285</b>
	200.5 mm	192 mm	<b>108.66.380</b>
	328.5 mm	320 mm	<b>108.66.286</b>
	500.5 mm	492 mm	<b>108.66.287</b>
 Brushed brass	136.5 mm	128 mm	<b>108.66.388</b>
	200.5 mm	192 mm	<b>108.66.389</b>
	328.5 mm	320 mm	<b>108.66.390</b>
	500.5 mm	492 mm	<b>108.66.391</b>
 Brushed copper	136.5 mm	128 mm	<b>108.66.376</b>
	200.5 mm	192 mm	<b>108.66.377</b>
	328.5 mm	320 mm	<b>108.66.378</b>
	500.5 mm	492 mm	<b>108.66.379</b>

FURNITURE HANDLES 2021, © Häfele U.K. Ltd 2021. Dimensional data not binding. We reserve the right to alter specifications without notice.

# Este



AT A GLANCE

KITCHEN APPLICATIONS

BEDROOM APPLICATIONS

BATHROOM APPLICATIONS

HANDLE FREE APPLICATIONS

INSTALLATION & DISPLAY

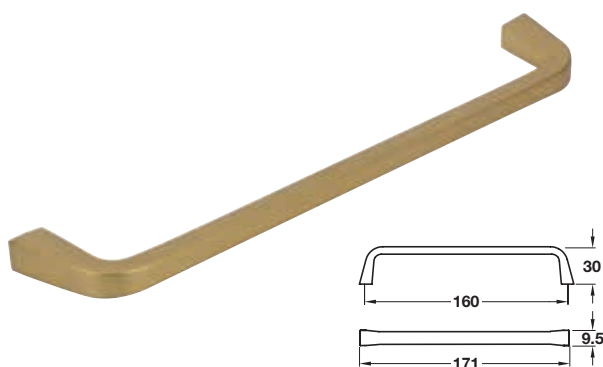

### ESTE pull handle

- > 2x M4 x 25 mm handle screws included
- > Zinc alloy
- > Order qty: 1 pc



Finish	Cat. No.
 Matt black	108.66.456
 Brushed nickel	108.66.446
 Brushed gold	108.66.445
 Brushed copper	108.66.455



➔ The COMO knob shown on page **323** matches the ESTE pull handle

## Burbridge

AT A GLANCE

KITCHEN APPLICATIONS

BEDROOM APPLICATIONS

BATHROOM APPLICATIONS

HANDLE FREE APPLICATIONS

INSTALLATION & DISPLAY

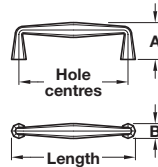

\*Product is subject to variations in finish due to the finishing and manufacturing process of certain materials

### BURBRIDGE pull handle



- > 2x M4 x 25 mm handle screws included
- > Brass or cast iron
- > Order qty: 1 pc



Finish	Length	Hole centres	Dim. A	Dim. B	Cat. No.
Polished nickel, brass	144 mm	128 mm	35 mm	15 mm	<b>116.35.745</b>
	176 mm	160 mm	37 mm	15 mm	<b>116.35.746</b>
Brushed brass, brass*	144 mm	128 mm	35 mm	15 mm	<b>116.35.545</b>
Antique copper, brass	144 mm	128 mm	35 mm	15 mm	<b>116.35.945</b>
Cast iron*	109 mm	96 mm	33 mm	13 mm	<b>116.35.344</b>
	212 mm	192 mm	40 mm	17 mm	<b>116.35.347</b>

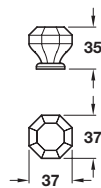

\*Product is subject to variations in finish due to the finishing and manufacturing process of certain materials

### BURBRIDGE knob



- > 1x M4 x 25 mm handle screw included
- > Brass
- > Order qty: 1 pc



Finish	Cat. No.
Brushed brass*	<b>123.03.510</b>
Polished nickel	<b>123.03.710</b>



# Brera

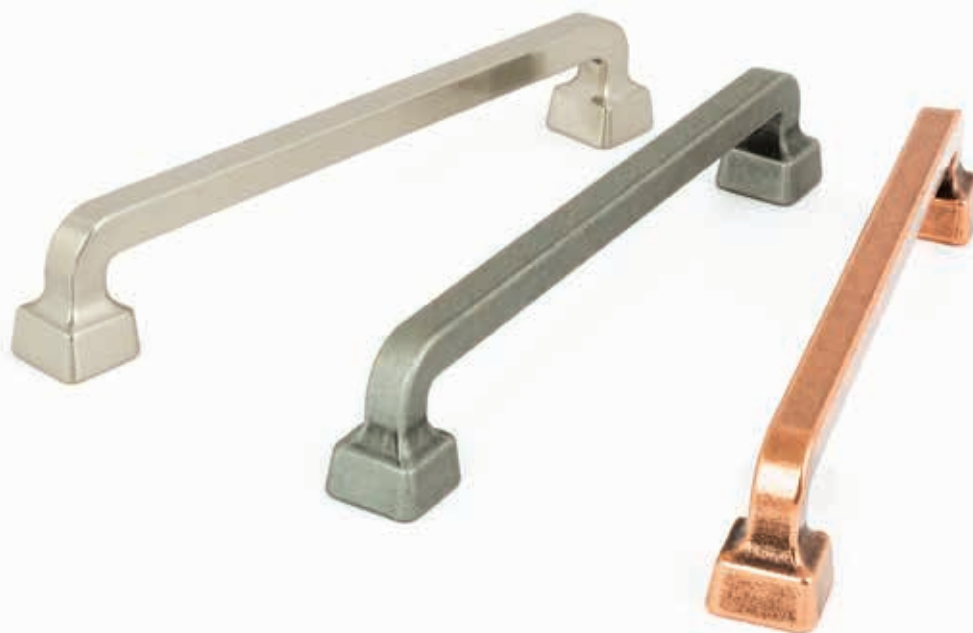

## BRERA D handle

- > Order M4 handle screws separately
- > Zinc alloy
- > Order qty: 1 pc

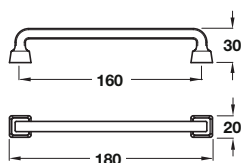

Finish	Cat. No.
Satin nickel	110.22.274
Antique copper	110.22.275
Pewter	110.22.276



Don't forget to order M4 handle screws, see page **353**  
 For our full range of fixing materials and installation tools see the Installation & Display section, pages **350-353**

## Caleido

AT A GLANCE

KITCHEN APPLICATIONS

BEDROOM APPLICATIONS

BATHROOM APPLICATIONS

HANDLE FREE APPLICATIONS

INSTALLATION & DISPLAY

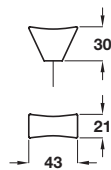
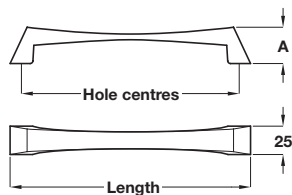

### CALEIDO D handle

- > 2x M4 x 25 mm handle screws included
- > Zinc alloy
- > Order qty: 1 pc



Finish	Length	Hole centres	Dim. A	Cat. No.
St. steel effect	150 mm	128 mm	31 mm	<b>110.22.662</b>
	214 mm	192 mm	32 mm	<b>110.22.664</b>
	342 mm	320 mm	34 mm	<b>110.22.668</b>
Polished chrome	150 mm	128 mm	31 mm	<b>110.22.262</b>
	214 mm	192 mm	32 mm	<b>110.22.268</b>
	342 mm	320 mm	34 mm	<b>110.22.268</b>

### CALEIDO knob

- > 1x M4 x 25 mm handle screw included
- > Zinc alloy
- > Order qty: 1 pc



Finish	Cat. No.
Stainless steel effect	<b>131.10.620</b>
Polished chrome	<b>131.10.220</b>



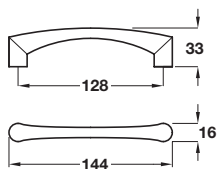

### EMERSON D handle

- > 2x M4 x 45 mm snap off handle screws included
- > Zinc alloy
- > Order qty: 1 pc



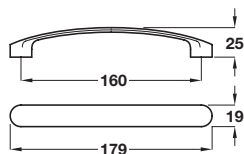

Finish	Cat. No.
 Matt nickel	101.71.022



### HARRINGTON D handle

- > 2x M4 x 45 mm snap off handle screws included
- > Zinc alloy
- > Order qty: 1 pc



Finish	Cat. No.
 Polished chrome	111.85.223
 Stainless steel effect	111.85.023

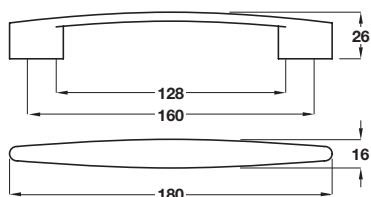

### MONTROSE D pull handle

- > Order M4 handle screws separately
- > Zinc alloy
- > Order qty: 1 pc



Finish	Cat. No.
 Polished chrome	110.34.236



Don't forget to order M4 handle screws, see page **353**  
For our full range of fixing materials and installation tools see the Installation & Display section, pages **350-353**

## Crystal

AT A GLANCE

KITCHEN APPLICATIONS

BEDROOM APPLICATIONS

BATHROOM APPLICATIONS

HANDLE FREE APPLICATIONS

INSTALLATION & DISPLAY

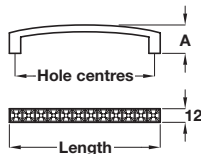

### CRYSTAL D handle

- > Order M4 handle screws separately
- > Made with CRYSTALLIZED™ Swarovski Elements
- > Zinc alloy
- > Order qty: 1 pc



Finish	Length	Hole centres	Dim. A	Cat. No.
	107 mm	96 mm	22 mm	<b>103.29.221</b>
	140 mm	128 mm	25 mm	<b>103.29.222</b>

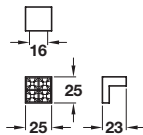

### CRYSTAL pull handle

- > Order M4 handle screws separately
- > Made with CRYSTALLIZED™ Swarovski Elements
- > Zinc alloy
- > Order qty: 1 pc



Finish	Cat. No.
Polished chrome	<b>132.19.240</b>

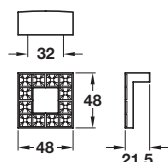

### CRYSTAL pull handle

- > 2x M4 x 25 mm handle screws included
- > Made with CRYSTALLIZED™ Swarovski Elements
- > Zinc alloy
- > Order qty: 1 pc



Finish	Cat. No.
Polished chrome	<b>132.19.220</b>

# Glacio

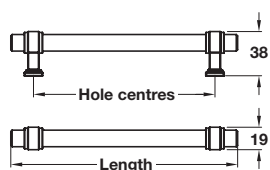

## GLACIO pull handle

- > 2x 8/32 x 1" (non-metric) screws included
- > Zinc/Glass
- > Order qty: 1 pc



Finish	Length	Hole centres	Cat. No.
Polished nickel / Clear	167 mm	128 mm	<b>133.53.039</b>
	200 mm	160 mm	<b>133.53.040</b>

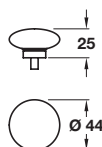

## GLACIO knob

- > 1x 8/32 x 1" (non-metric) screw included
- > Zinc/Glass
- > Order qty: 1 pc



Finish	Cat. No.
Polished nickel / Clear	<b>133.50.122</b>

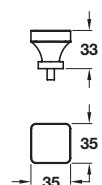

## GLACIO square knob

- > 1x 8/32 x 1" (non-metric) screw included
- > Zinc/Glass
- > Order qty: 1 pc



Finish	Cat. No.
Polished nickel / Clear	<b>133.50.120</b>



All handles on this page include 8/32 x 1" (non-metric) screws. If you require a different length order non-metric cut off screw Cat. No. 022.24.881 shown on page **353**

## Byron

AT A GLANCE

KITCHEN APPLICATIONS

BEDROOM APPLICATIONS

BATHROOM APPLICATIONS

HANDLE FREE APPLICATIONS

INSTALLATION & DISPLAY

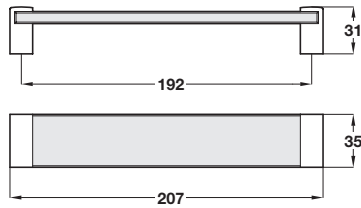

### BYRON bar handle

- > 2x M4 x 25 mm handle screws included
- > Zinc alloy, with tempered glass
- > Order qty: 1 pc



Finish	Cat. No.
 Polished chrome with clear glass	<b>108.80.507</b>

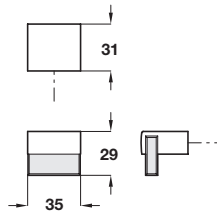

### BYRON knob

- > 1x M4 x 25 mm handle screw included
- > Zinc alloy, with tempered glass
- > Order qty: 1 pc



Finish	Cat. No.
 Polished chrome with clear glass	<b>131.14.200</b>

# VIEW OUR COMPLETE ACCESSIBLE BATHROOMS RANGE 24/7

With our extensive range of bathroom fittings and accessories, Häfele can fulfil any accessible bathroom fitting requirements across both commercial and residential landscapes.



VISIT [HAFELE.CO.UK](http://HAFELE.CO.UK) TO VIEW THE FULL RANGE

## Dimple

AT A GLANCE

KITCHEN APPLICATIONS

BEDROOM APPLICATIONS

BATHROOM APPLICATIONS

HANDLE FREE APPLICATIONS

INSTALLATION & DISPLAY

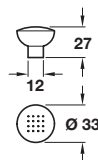
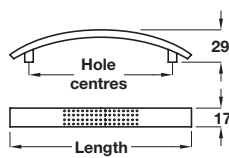

### DIMPLE bow handle

- > Order M4 handle screws separately
- > Zinc alloy
- > Order qty: 1 pc



Finish	Length	Hole centres	Cat. No.
Polished chrome	126 mm	96 mm	<b>101.69.201</b>
	158 mm	128 mm	<b>101.69.202</b>
Matt nickel	126 mm	96 mm	<b>101.69.601</b>
	158 mm	128 mm	<b>101.69.602</b>
Stainless steel effect	126 mm	96 mm	<b>101.69.001</b>
	158 mm	128 mm	<b>101.69.002</b>

### DIMPLE knob

- > Order M4 handle screws separately
- > \*1x M4 x 25 mm screw included
- > Zinc alloy
- > Order qty: 1 pc



Finish	Cat. No.
Polished chrome	<b>135.48.202</b>
Matt nickel	<b>135.48.402</b>
Stainless steel effect	<b>135.48.002*</b>





### QUIGLEY bow handle

- > Order M4 handle screws separately
- > Zinc alloy
- > Order qty: 1 pc

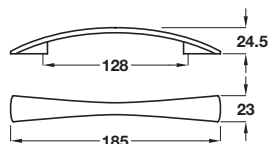

Finish	Cat. No.
Polished chrome	109.29.202
Matt nickel	109.29.602
Aluminium coloured	109.29.402



### OCTAVIA lightweight bow handle

- > Order M4 handle screws separately
- > Zinc alloy
- > Order qty: 1 pc

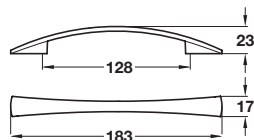

Finish	Cat. No.
Matt nickel	102.33.605
Polished chrome	102.33.205



### CHISWICK bow handle

- > Order M4 handle screws separately
- > Zinc alloy
- > Order qty: 1 pc

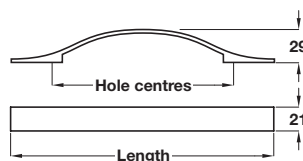

Finish	Length	Hole centres	Cat. No.
Polished chrome	232 mm	160 mm	108.89.243
Stainless steel effect			108.89.043



Don't forget to order M4 handle screws, see page **353**  
For our full range of fixing materials and installation tools see the Installation & Display section, pages **350-353**

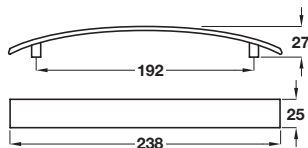

### CICERO bow handle

- > Order M4 handle screws separately
- > Zinc alloy
- > Order qty: 1 pc



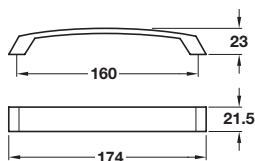

Finish	Cat. No.
 Stainless steel effect	102.35.034



### TAVISTOCK bow handle

- > 2 each of M4 x 22 mm and M4 x 25 mm handle screws included
- > \*2x M4 x 45 mm snap off handle screws included
- > Aluminium
- > Order qty: 1 pc



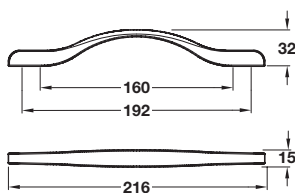

Finish	Cat. No.
 Polished chrome	109.53.226
 Stainless steel effect	109.53.626*



### HENLEY bow handle

- > Order M4 handle screws separately
- > Zinc alloy
- > Order qty: 1 pc



Finish	Cat. No.
 Light bronze	108.89.116
 Graphite	108.89.516



Don't forget to order M4 handle screws, see page **353**  
For our full range of fixing materials and installation tools see the Installation & Display section, pages **350-353**

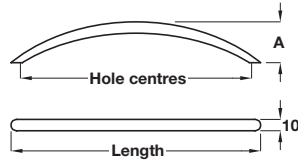

### INDIGO bow handle

- > Order M4 handle screws separately
- > Steel
- > Order qty: 1 pc



Finish	Length	Hole centres	Dim. A	Cat. No.
 Polished chrome	111 mm	96 mm	30 mm	<b>117.31.222</b>
	148 mm	128 mm	30 mm	<b>117.31.231</b>
	184 mm	160 mm	32 mm	<b>117.31.241</b>
	297 mm	256 mm	32 mm	<b>117.31.261</b>
 Matt black	151 mm	128 mm	30 mm	<b>106.43.302</b>
	187 mm	160 mm	32 mm	<b>106.43.303</b>

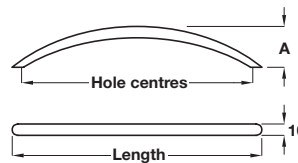

### Bow handle

- > Order M4 handle screws separately
- > Steel
- > Order qty: 1 pc



Finish	Length	Hole centres	Dim. A	Cat. No.
 Aluminium coloured	118 mm	96 mm	24 mm	<b>106.43.401</b>
	151 mm	128 mm	30 mm	<b>106.43.402</b>
	187 mm	160 mm	32 mm	<b>106.43.403</b>
	320 mm	288 mm	40 mm	<b>106.43.407</b>
 Polished brass	118 mm	96 mm	24 mm	<b>106.43.801</b>
	151 mm	128 mm	30 mm	<b>106.43.802</b>
	187 mm	160 mm	32 mm	<b>106.43.803</b>
	320 mm	288 mm	40 mm	<b>106.43.807</b>

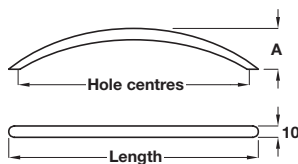

### CLIFTON bow handle

- > Order M4 handle screws separately
- > \*2x M4 handle screws included
- > Steel
- > Order qty: 1 pc



Finish	Length	Hole centres	Dim. A	Cat. No.
 Brushed stainless steel effect	111 mm	96 mm	30 mm	<b>117.31.021</b>
	148 mm	128 mm	30 mm	<b>117.31.031*</b>
	184 mm	160 mm	32 mm	<b>117.31.041</b>
	221 mm	192 mm	32 mm	<b>117.31.052</b>
	258 mm	224 mm	32 mm	<b>117.31.053</b>
	332 mm	288 mm	32 mm	<b>117.31.071</b>

Hudson

AT A GLANCE

KITCHEN APPLICATIONS

BEDROOM APPLICATIONS

BATHROOM APPLICATIONS

HANDLE FREE APPLICATIONS

INSTALLATION & DISPLAY

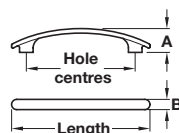

**HUDSON bow handle**

- > 2x M4 x 45 mm snap off screws included
- > Zinc alloy
- > Order qty: 1 pc



Finish	Length	Hole centres	Dim. A	Cat. No.
Polished chrome	90 mm	64 mm	19 mm	<b>102.34.210</b>
	123 mm	96 mm	21 mm	<b>102.34.211</b>
	157 mm	128 mm	22 mm	<b>102.34.212</b>
	190 mm	160 mm	24 mm	<b>102.34.213</b>
	256 mm	224 mm	27 mm	<b>102.34.215</b>
	320 mm	288 mm	33 mm	<b>102.34.217</b>

# Cordelia

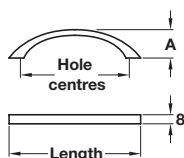

## CORDELIA bow handle

- > Order M4 handle screws separately
- > Zinc alloy
- > Order qty: 1 pc



Finish	Length	Hole centres	Dim. A	Cat. No.
Polished chrome	86.5 mm	64 mm	19 mm	<b>107.66.210</b>
	150 mm	128 mm	31 mm	<b>107.66.212</b>
	186 mm	160 mm	31.5 mm	<b>107.66.213</b>
	318 mm	288 mm	38.5 mm	<b>107.66.217</b>



Don't forget to order M4 handle screws, see page **353**  
 For our full range of fixing materials and installation tools see the Installation & Display section, pages **350-353**

## Henrietta

AT A GLANCE

KITCHEN APPLICATIONS

BEDROOM APPLICATIONS

BATHROOM APPLICATIONS

HANDLE FREE APPLICATIONS

INSTALLATION & DISPLAY

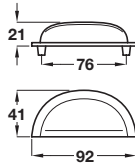

The MAYBERRY knob shown on page 133 also matches the HENRIETTA cup handle

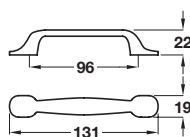
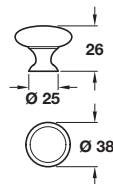

### HENRIETTA cup handle



- > 2x M4 x 25 mm and 2x M4 x 45 mm snap off handle screws included
- > \*Order M4 handle screws separately
- > Zinc alloy
- > Order qty: 1 pc



Finish	Cat. No.
Polished chrome	166.11.204*
Stainless steel effect	166.11.400*
Polished black nickel	166.11.305

### HENRIETTA knob



- > 1x M4 x 25 mm handle screw included
- > Zinc alloy
- > Order qty: 1 pc



Finish	Cat. No.
Polished chrome	134.39.210
Stainless steel effect	134.39.020

### HENRIETTA D handle



- > 2x M4 x 25 mm handles screws and 2x M4 x 45 mm snap off handle screws included
- > \*Order fixing screws separately
- > Aluminium
- > Order qty: 1 pc



Finish	Cat. No.
Polished chrome	109.48.224
Stainless steel effect	118.53.600*

# Ariel

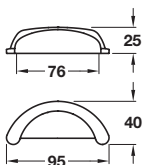

## ARIEL cup handle



- > 2 each of M4 x 20 mm, 22 mm and 27 mm handle screws included
- > \*Order fixing screws separately for polished chrome finish
- > Zinc alloy
- > Order qty: 1 pc



Finish	Cat. No.
Polished chrome	166.11.240*
Pewter effect	166.11.905

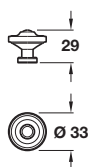

## ARIEL knob



- > 1 each of M4 x 22 mm and 27 mm handle screws included
- > \*Order fixing screws separately for polished chrome finish
- > Zinc alloy
- > Order qty: 1 pc



Finish	Cat. No.
Polished chrome	134.06.200*
Pewter effect	166.11.900



Don't forget to order M4 handle screws, see page **353**  
 For our full range of fixing materials and installation tools see the Installation & Display section, pages **350-353**

## Odessa

AT A GLANCE

KITCHEN APPLICATIONS

BEDROOM APPLICATIONS

BATHROOM APPLICATIONS

HANDLE FREE APPLICATIONS

INSTALLATION & DISPLAY

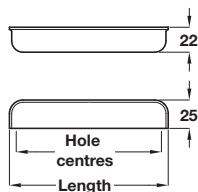

### ODESSA cup handle

- > Order M4 handle screws separately
- > Zinc alloy
- > Order qty: 1 pc



Finish	Length	Hole centres	Cat. No.
Polished chrome	78 mm	64 mm	<b>151.40.660</b>
	140 mm	128 mm	<b>151.40.665</b>
Stainless steel effect	78 mm	64 mm	<b>151.40.661</b>
	140 mm	128 mm	<b>151.40.666</b>
Brushed copper	78 mm	64 mm	<b>151.40.662</b>
	140 mm	128 mm	<b>151.40.667</b>



### ODESSA knob

- > Order M4 handle screws separately
- > Zinc alloy
- > Order qty: 1 pc



Finish	Cat. No.
Polished chrome	<b>110.35.360</b>
Stainless steel effect	<b>110.35.361</b>
Brushed copper	<b>110.35.362</b>



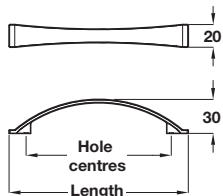

### ODESSA bow handle



- > Order M4 handle screws separately
- > Zinc alloy
- > Order qty: 1 pc



Finish	Length	Hole centres	Cat. No.
Polished chrome	158 mm	128 mm	<b>107.03.610</b>
Stainless steel effect			<b>107.03.611</b>
Brushed copper			<b>107.03.613</b>

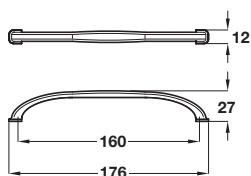

### ODESSA bow handle



- > Order M4 handle screws separately
- > Zinc alloy
- > Order qty: 1 pc



Finish	Cat. No.
Polished chrome	<b>107.03.615</b>
Stainless steel effect	<b>107.03.616</b>
Brushed copper	<b>107.03.617</b>



Don't forget to order M4 handle screws, see page **353**  
 For our full range of fixing materials and installation tools see the Installation & Display section, pages **350-353**

## Delia

AT A GLANCE

KITCHEN APPLICATIONS

BEDROOM APPLICATIONS

BATHROOM APPLICATIONS

HANDLE FREE APPLICATIONS

INSTALLATION & DISPLAY

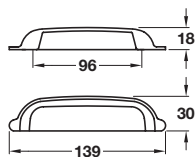



\*Product is subject to variations in finish due to the finishing and manufacturing process of certain materials

### DELIA cup handle

- > Order M4 handle screws separately
- > Brass
- > Order qty: 1 pc



Finish	Cat. No.
 Brushed brass*	110.35.115
 Polished nickel	110.35.116
 Antique copper*	110.35.117

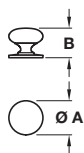



\*Product is subject to variations in finish due to the finishing and manufacturing process of certain materials

### DELIA knob

- > Order M4 handle screw separately
- > Brass
- > Order qty: 1 pc



Finish	Dim. A	Dim. B	Cat. No.
 Brushed brass*	Ø 30 mm	26 mm	110.35.110
	Ø 35 mm	28 mm	110.35.105
 Polished nickel	Ø 30 mm	26 mm	110.35.111
	Ø 35 mm	28 mm	110.35.106
 Antique copper*	Ø 30 mm	26 mm	110.35.112
	Ø 35 mm	28 mm	110.35.107

# Jude

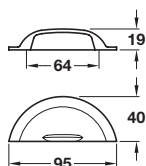

\*Product is subject to variations in finish due to the finishing and manufacturing process of certain materials

## JUDE cup handle

- > Order M4 handle screws separately
- > Brass
- > Order qty: 1 pc



Finish	Cat. No.
 Brushed brass*	110.35.120
 Polished nickel	110.35.121
 Antique copper*	110.35.122

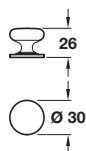

\*Product is subject to variations in finish due to the finishing and manufacturing process of certain materials

## JUDE knob

- > Order M4 handle screw separately
- > Brass
- > Order qty: 1 pc



Finish	Cat. No.
 Brushed brass*	110.35.100
 Polished nickel	110.35.101
 Antique copper*	110.35.102

Mulberry

AT A GLANCE

KITCHEN APPLICATIONS

BEDROOM APPLICATIONS

BATHROOM APPLICATIONS

HANDLE FREE APPLICATIONS

INSTALLATION & DISPLAY

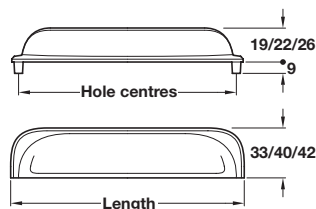

Note: ± 3 mm tolerance on non-critical dimensions and ±1 mm on hole centre dimensions

**MULBERRY cup handle**

- > Order M4 handle screws separately
- > \*2x M4 x 25 mm handle screws included
- > Brass
- > Order qty: 1 pc



Finish	Length	Hole centres	Cat. No.
Polished nickel	77 mm	64 mm	<b>151.40.203*</b>
	108 mm	96 mm	<b>151.40.204*</b>
	204 mm	192 mm	<b>151.40.207*</b>
Polished chrome	108 mm	96 mm	<b>151.40.254</b>
Brushed copper	108 mm	96 mm	<b>151.40.154</b>

➔ Don't forget to order M4 handle screws, see page **353**  
 For our full range of fixing materials and installation tools see the Installation & Display section, pages **350-353**

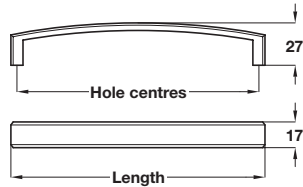

Note: ± 3 mm tolerance on non-critical dimensions and ±1 mm on hole centre dimensions

### MULBERRY D handle

- > 2x M4 x 25 mm handle screws included
- > Brass
- > Order qty: 1 pc



Finish	Length	Hole centres	Cat. No.
Polished nickel	135 mm	128 mm	<b>116.35.255</b>
	168 mm	160 mm	<b>116.35.256</b>

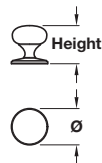

Note: ± 3 mm tolerance on non-critical dimensions

### MULBERRY knob

- > Order M4 handle screws separately
- > \*1x M4 x 25 mm handle screw included
- > Brass
- > Order qty: 1 pc



Finish	Diameter	Height	Cat. No.
Polished nickel	Ø 32 mm	36 mm	<b>123.02.700*</b>
	Ø 38 mm	42 mm	<b>123.02.710*</b>
Polished chrome	Ø 38 mm	42 mm	<b>134.97.220</b>
Brushed copper	Ø 38 mm	42 mm	<b>134.97.020</b>

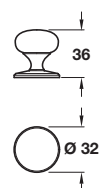

Note: ± 3 mm tolerance on non-critical dimensions and ±1 mm on hole centre dimensions

### MULBERRY knob

- > 1x M4 x 25 mm handle screw included
- > Brass
- > Order qty: 1 pc



Finish	Cat. No.
Polished chrome	<b>135.07.230</b>
Stainless steel effect	<b>135.07.600</b>

## Kane

AT A GLANCE

KITCHEN APPLICATIONS

BEDROOM APPLICATIONS

BATHROOM APPLICATIONS

HANDLE FREE APPLICATIONS

INSTALLATION & DISPLAY

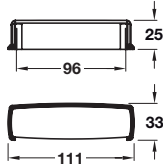

Product is subject to variations in finish due to the finishing and manufacturing process of certain materials

### KANE cup handle

- > 2x 8/32 x 1" (non-metric) screws included
- > Zinc alloy
- > Order qty: 1 pc



Finish	Cat. No.
 Oil rubbed bronze	<b>133.50.140</b>

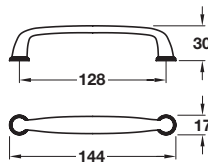

Product is subject to variations in finish due to the finishing and manufacturing process of certain materials

### KANE pull handle

- > 2x 8/32 x 1" (non-metric) screws included
- > Zinc alloy
- > Order qty: 1 pc



Finish	Cat. No.
 Oil rubbed bronze	<b>133.50.340</b>

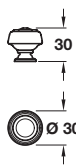

Product is subject to variations in finish due to the finishing and manufacturing process of certain materials

### KANE knob

- > 1x 8/32 x 1" (non-metric) screw included
- > Zinc alloy
- > Order qty: 1 pc



Finish	Cat. No.
 Oil rubbed bronze	<b>133.50.609</b>



All handles on this page include 8/32 x 1" (non-metric) screws. If you require a different length order non-metric cut off screw Cat. No. 022.24.881 shown on page **353**

# Crawford

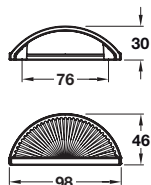

\*Product is subject to variations in finish due to the finishing and manufacturing process of certain materials

## CRAWFORD cup handle



- > 2x 8/32 x 1" (non-metric) screws included
- > Zinc alloy
- > Order qty: 1 pc



Finish	Cat. No.
Golden champagne	133.50.143
Oil rubbed bronze*	133.50.144

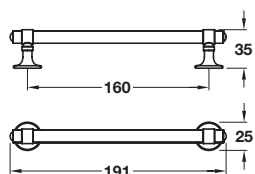

\*Product is subject to variations in finish due to the finishing and manufacturing process of certain materials

## CRAWFORD pull handle



- > 2x 8/32 x 1" (non-metric) screws included
- > Zinc alloy
- > Order qty: 1 pc



Finish	Cat. No.
Golden champagne	133.50.374
Oil rubbed bronze*	133.50.377

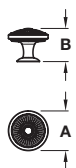

\*Product is subject to variations in finish due to the finishing and manufacturing process of certain materials

## CRAWFORD knob



- > 1x 8/32 x 1" (non-metric) screw included
- > Zinc alloy
- > Order qty: 1 pc



Finish	Dim. A	Dim. B	Cat. No.
Golden champagne	Ø 35 mm	30 mm	133.50.303
Oil rubbed bronze*	Ø 35 mm	30 mm	133.50.305



### EGG TIMER knob

- > 1x M4 x 30 mm handle screw and 2x washers included
- > Aluminium
- > Order qty: 1 pc

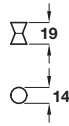

Finish	Cat. No.
Polished nickel	<b>133.99.601</b>



### AMBER knob

- > Order M4 handle screws separately
- > Zinc alloy
- > Order qty: 1 pc

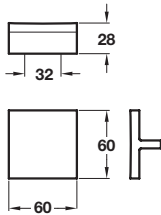

Finish	Cat. No.
Polished chrome	<b>131.14.260</b>



### JUPITER knob

- > 1x M4 x 25 mm handle screw included
- > Brass
- > Order qty: 1 pc

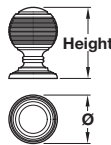

Finish	Diameter	Height	Cat. No.
Stainless steel effect	Ø 32 mm	44 mm	<b>123.02.080</b>
	Ø 38 mm	52 mm	<b>135.07.610</b>

Note: ± 3 mm tolerance on non-critical dimensions and ±1 mm on hole centre dimensions



Don't forget to order M4 handle screws, see page **353**  
For our full range of fixing materials and installation tools see the Installation & Display section, pages **350-353**



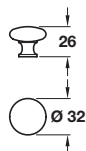

### ORIEL knob

- > Order M4 handle screws separately
- > Zinc alloy
- > Order qty: 1 pc



Finish	Cat. No.
Matt nickel	134.02.600
Stainless steel effect	135.24.600
Polished chrome	133.09.200

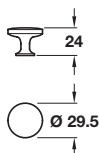

### CASSIUS knob

- > Order M4 handle screws separately
- > Zinc alloy
- > Order qty: 1 pc



Finish	Cat. No.
Stainless steel effect	137.35.600

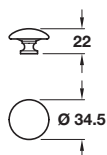

### AMELIA knob

- > 1x M4 x 25 mm handle screw included
- > \*Order M4 handle screws separately
- > Zinc alloy
- > Order qty: 1 pc



Finish	Cat. No.
Matt nickel	135.00.600
Stainless steel effect	133.10.600*
Polished chrome	133.10.200*

## Rocher & Balley

AT A GLANCE

KITCHEN APPLICATIONS

BEDROOM APPLICATIONS

BATHROOM APPLICATIONS

HANDLE FREE APPLICATIONS

INSTALLATION & DISPLAY

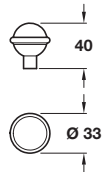

Note: ± 3 mm tolerance on non-critical dimensions

### ROCHER knob

- > 1x M4 x 25 mm handle screw included
- > Brass
- > Order qty: 1 pc



Finish	Cat. No.
 Polished nickel	<b>137.80.730</b>

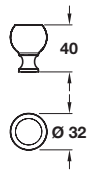

Note: ± 3 mm tolerance on non-critical dimensions

### BALLEY knob

- > 1x M4 x 25 mm handle screw included
- > Brass
- > Order qty: 1 pc



Finish	Cat. No.
 Polished nickel	<b>135.07.720</b>



SULA knob shown on page **164** also available



Rocher knob Cat. No. 137.80.730 shown on round backplate Cat. No. 137.80.740

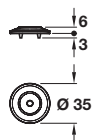

Note: ± 3 mm tolerance on non-critical dimensions

### Round backplate



- > Order M4 handle screw separately
- > Brass
- > Order qty: 1 pc



Finish	Cat. No.
 Polished nickel	137.80.740

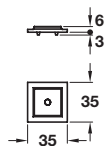

Note: ± 3 mm tolerance on non-critical dimensions

### Square backplate



- > Order M4 handle screw separately
- > Brass
- > Order qty: 1 pc



Finish	Cat. No.
 Polished nickel	137.80.750

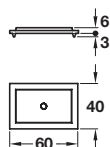

Note: ± 3 mm tolerance on non-critical dimensions

### Rectangular backplate



- > Order M4 handle screw separately
- > Brass
- > Order qty: 1 pc



Finish	Cat. No.
 Polished nickel	137.80.760

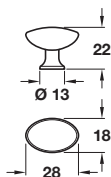
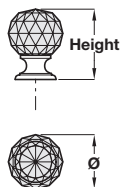

### HARLEY knob

- > 1x M4 x 22 mm and 1x M4 x 25 mm handle screws included
- > Glass knob with brass base
- > Order qty: 1 pc





Finish	Length	Height	Cat. No.
 Polished chrome	Ø 30 mm	41 mm	<b>139.60.422</b>
	Ø 35 mm	45 mm	<b>139.60.423</b>

### PEARL knob

- > Order M4 handle screws separately
- > Zinc alloy
- > Order qty: 1 pc



Finish	Cat. No.
 Polished chrome	<b>133.09.210</b>
 Satin nickel	<b>133.09.410</b>
 Brushed copper	<b>133.09.010</b>



# Como





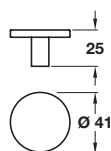

➔ The ESTE pull handle shown on page 293 matches the COMO knob



## COMO knob

- > 1x M4 x 25 mm handle screw included
- > Zinc alloy
- > Order qty: 1 pc



Finish	Cat. No.
 Matt black	106.66.287
 Brushed nickel	106.66.285
 Brushed gold	106.66.284
 Brushed copper	106.66.286

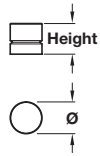

### ACER knob

- > 1x M4 x 25 mm handle screw included
- > Stainless steel
- > Order qty: 1 pc



Finish	Diameter	Height	Cat. No.
Stainless steel	Ø 18 mm	23 mm	<b>134.88.611</b>
	Ø 28 mm	27 mm	<b>134.88.610</b>

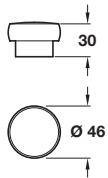

### ACACIA knob

- > Order M4 handle screws separately
- > Zinc alloy
- > Order qty: 1 pc



Finish	Cat. No.
Stainless steel effect	<b>131.15.000</b>



Don't forget to order M4 handle screws, see page **353**  
 For our full range of fixing materials and installation tools see the Installation & Display section, pages **350-353**



### CHLOEU knob

- > Order M4 handle screws separately
- > Brass
- > Order qty: 1 pc

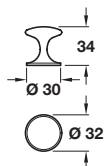

\*Product is subject to variations in finish due to the finishing and manufacturing process of certain materials

Finish	Cat. No.
Brushed brass*	123.03.500
Polished nickel	123.03.700



### KEW knob

- > 1x M4 x 25 mm handle screw included
- > Brass
- > Order qty: 1 pc

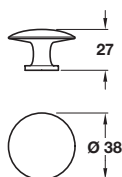

Note: ± 3 mm tolerance on non-critical dimensions

Finish	Cat. No.
Polished chrome	134.97.482
Stainless steel effect	134.97.083



### CONSTANCE knob

- > Order M4 handle screws separately
- > Zinc alloy
- > Order qty: 1 pc

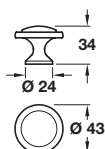

Finish	Cat. No.
Polished chrome	134.45.220
Stainless steel effect	134.45.620

## Oberon

AT A GLANCE

KITCHEN APPLICATIONS

BEDROOM APPLICATIONS

BATHROOM APPLICATIONS

HANDLE FREE APPLICATIONS

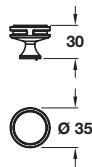

INSTALLATION & DISPLAY



### OBERON knob

- > 1x 8/32 x 1" (non-metric) screw included
- > Zinc alloy
- > Order qty: 1 pc



Finish	Cat. No.
 Golden champagne	<b>133.50.618</b>
 Polished nickel	<b>133.50.622</b>



All handles on this page include 8/32 x 1" (non-metric) screws. If you require a different length order non-metric cut off screw Cat. No. 022.24.881 shown on page **353**





### CORBUSIER knob

- > 1x M4 handle screw included
- > Zinc alloy
- > Order qty: 1 pc

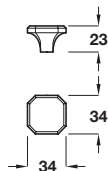





Finish	Cat. No.
 Polished chrome	<b>123.08.260</b>

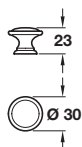

### ANGUS knob

- > Order M4 handle screws separately
- > Zinc alloy
- > Order qty: 1 pc



Finish	Cat. No.
 Polished chrome	<b>118.06.214</b>
 Matt nickel	<b>118.06.616</b>
 Antique brass	<b>118.06.116</b>



Don't forget to order M4 handle screws, see page **353**  
For our full range of fixing materials and installation tools see the Installation & Display section, pages **350-353**

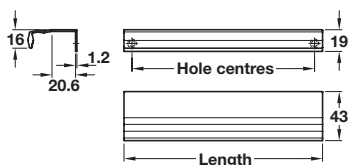
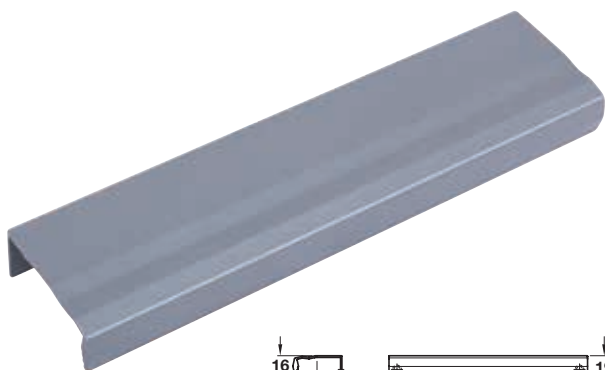

### LINE profile handle

- > Order M4 handle screws separately
- > Aluminium
- > Order qty: 1 pc



Finish	Length	Hole centres	Cat. No.
Matt anthracite	78 mm	64 mm	<b>111.71.510</b>
	174 mm	160 mm	<b>111.71.511</b>
	334 mm	320 mm	<b>111.71.512</b>

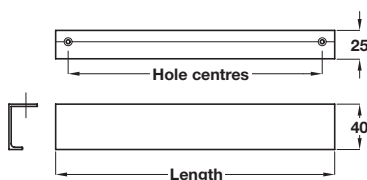
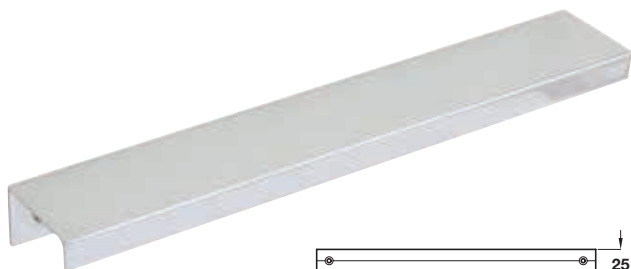

### LISTER trim handle

- > Order screws separately
- > Aluminium
- > Order qty: 1 pc



Finish	Length	Hole centres	Cat. No.
Brushed nickel	147 mm	128 mm	<b>126.17.641</b>
	297 mm	256 mm	<b>126.17.642</b>

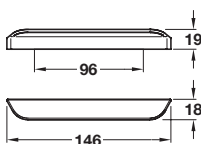

### OXFORD pull handle

- > 2x M4 x 25 mm handle screws and 2x M4 x 45 mm snap off handle screws included
- > Zinc alloy
- > Order qty: 1 pc



Finish	Cat. No.
Polished chrome	<b>102.18.224</b>



Don't forget to order M4 handle screws, see page **353**  
For our full range of fixing materials and installation tools see the Installation & Display section, pages **350-353**

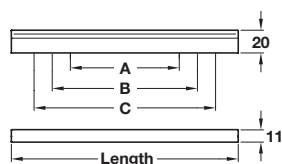

# Angle



## ANGLE pull handle

- > 2x M4 x 25 mm handle screws included
- > Aluminium
- > Order qty: 1 pc



Finish	Length	Hole centres			Cat. No.
		A	B	C	
 Polished chrome	200 mm	96 mm	128 mm	160 mm	<b>108.66.230</b>
	400 mm	256 mm	320 mm	-	<b>108.66.231</b>
	500 mm	416 mm	320 mm	-	<b>108.66.232</b>
	900 mm	640 mm	-	-	<b>108.66.234</b>
 Matt black	200 mm	128 mm	160 mm	-	<b>108.66.330</b>
 Stainless steel effect	200 mm	96 mm	128 mm	160 mm	<b>108.66.030</b>

## Nick

AT A GLANCE

KITCHEN APPLICATIONS

BEDROOM APPLICATIONS

BATHROOM APPLICATIONS

HANDLE FREE APPLICATIONS

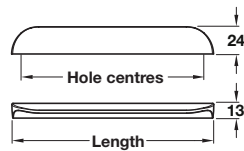

INSTALLATION & DISPLAY



### NICK pull handle

- > 2x M4 x 25 mm handle screws included
- > Aluminium
- > Order qty: 1 pc



Finish	Length	Hole centres	Cat. No.
 Brushed copper	50 mm	32 mm	<b>126.45.060</b>
	178 mm	160 mm	<b>126.45.061</b>
 Brushed brass	50 mm	32 mm	<b>126.45.062</b>
	178 mm	160 mm	<b>126.45.063</b>

# Noma

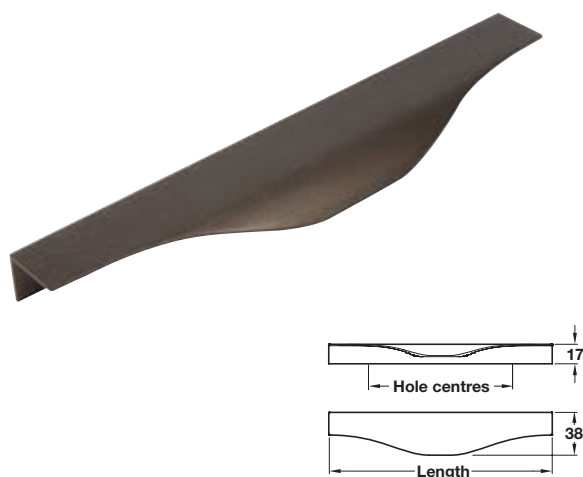

## NOMA profile handle

- > 2x M4 x 15 mm handle screws included
- > Aluminium
- > Order qty: 1 pc



Finish	Length	Hole centres	Cat. No.
Stainless steel effect	200 mm	128 mm	<b>126.45.045</b>
	350 mm	256 mm	<b>126.45.048</b>
Bright anodised	200 mm	128 mm	<b>126.45.965</b>
	350 mm	256 mm	<b>126.45.969</b>
Antique bronze	200 mm	128 mm	<b>126.45.046</b>
	350 mm	256 mm	<b>126.45.049</b>

FURNITURE HANDLES 2021, © Häfele U.K. Ltd 2021. Dimensional data not binding. We reserve the right to alter specifications without notice.

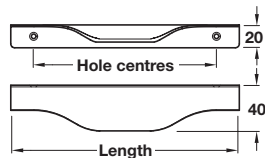

### PATIENCE profile handle



- > Order M4 handle screws separately
- > Aluminium
- > Order qty: 1 pc



Finish	Length	Hole centres	Cat. No.
Brushed copper	200 mm	160 mm	<b>126.17.230</b>
	300 mm	256 mm	<b>126.17.231</b>
	400 mm	320 mm	<b>126.17.232</b>

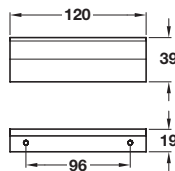

Note: ± 3 mm tolerance on non-critical dimensions and ±1 mm on hole centre dimensions

### RUBY trim handle



- > 2x Ø 3.0 x 13 mm countersunk head screws included
- > Brass
- > Order qty: 1 pc



Finish	Cat. No.
Brushed copper	<b>112.84.024</b>
Polished nickel	<b>112.84.724</b>



Don't forget to order M4 handle screws, see page **353**  
For our full range of fixing materials and installation tools see the Installation & Display section, pages **350-353**

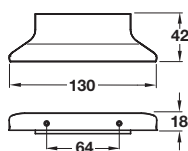
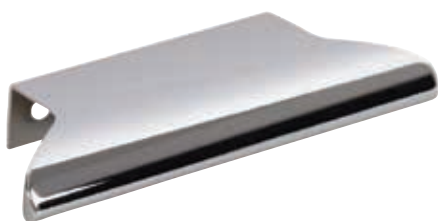

# Rita



## RITTA profile handle

- > 2x Ø3.5 x 15 mm countersunk screws included
- > Zinc alloy
- > Order qty: 1 pc



Finish	Cat. No.
 Polished chrome	126.45.050
 Stainless steel effect	126.45.051
 Matt black	126.45.052

## GOLA Profiles for Handle Free Applications

Profiles for recess mounting in the cabinet carcass to create a streamlined look with no handles in view

Gola Profile systems are ideal to achieve a contemporary, sleek kitchen design. Compared to more traditional cabinet handles, profile handles give a flush-fitting, handle-less style. You could opt for a Gola Profile in a similar tone to the cabinet for a seamless finish, or a contrasting colour will make more of a contemporary design statement.

Our on-trend range of complementary Gola profiles and plinths offers maximum style and functionality.

There are six different systems in a choice of seven finishes available from Häfele to suit a variety of different applications.

### Key features:

- > Choice of 7 finishes; anodised or powder coated aluminium
- > High quality, on trend design
- > Extensive variety of options



System B Plus, System C Plus, System D and System E profiles with aluminium plinth profile, graphite powder coated finish





System B Plus profile, silver anodised finish



System B Plus and System C Plus profiles, silver anodised finish



System B Plus and System C Plus profiles with aluminium plinth profile, brushed copper anodised finish

FURNITURE HANDLES 2021, © Häfele U.K. Ltd 2021. Dimensional data not binding. We reserve the right to alter specifications without notice.

**GOLA system profiles are available for different applications where a streamlined handle free look is required.**

- > **System A:** For horizontal fixing under wall units; page **339**
- > **Original system B:** For horizontal fixing under worktops, with plastic connectors; page **340**
- > **Original system C:** For horizontal fixing between doors and drawers, with plastic connectors; page **341**
- > **System B Plus:** For horizontal fixing under worktops, with aluminium profile connectors; page **342**
- > **System C Plus:** For horizontal fixing between doors and drawers, with aluminium profile connectors; page **343**
- > **System D and E:** For vertical fixing between doors; pages **344-345**

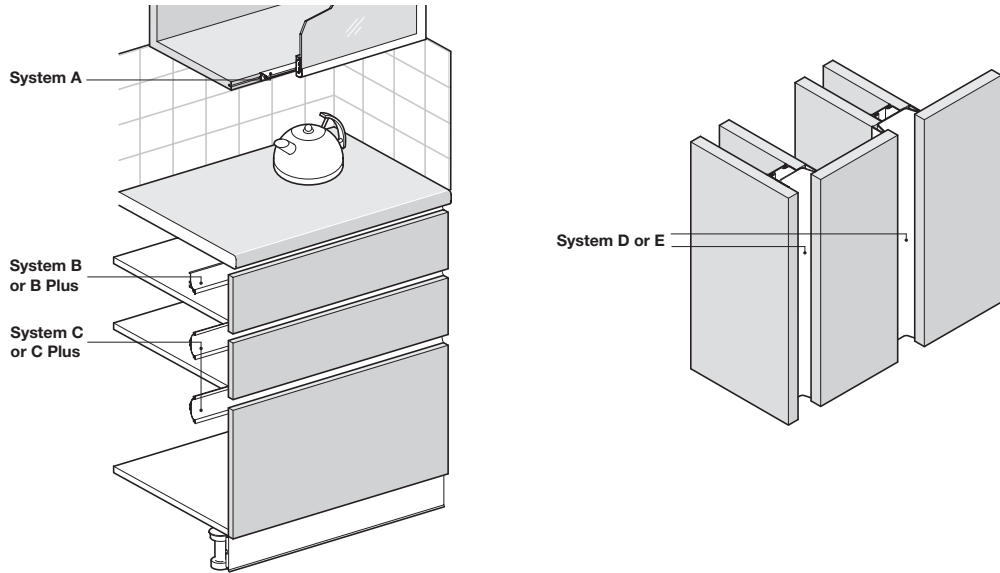

Please note: The Gola profile dimension does not allow for use with a fully integrated dishwasher, the profile stops at the dishwasher. The dishwashers door will need a handle

EXAMPLE SYSTEM SELECTION				
Item description	Order qty	Finish	Cat. No.	Page
<b>GOLA System A - Horizontal fixing under wall units</b>				
Profile for horizontal fixing under wall units, without soft lip shock absorber	3.9 m length	Silver anodised aluminium	<b>126.48.900</b>	<b>339</b>
Profile for horizontal fixing under wall units, with soft lip shock absorber	3.9 m length	Silver anodised aluminium	<b>126.48.910</b>	<b>339</b>
Profile for horizontal fixing under wall units, with slot for LED strip	4.1 m length	Silver anodised aluminium	<b>126.48.920</b>	<b>339</b>
<b>GOLA Original System B - Horizontal fixing under worktops, with plastic connectors</b>				
Profile for horizontal fixing under worktops	3.9 m length	Silver anodised aluminium	<b>712.63.900</b>	<b>340</b>
Profile connector	1 pair	Red plastic	<b>712.63.511</b>	<b>340</b>
Profile connector with end panel cover	1 pair	Black plastic	<b>712.63.510</b>	<b>340</b>
Exterior trim caps	1 pair	Grey plastic	<b>712.63.540</b>	<b>340</b>
Interior trim caps	1 pair	Grey plastic	<b>712.63.541</b>	<b>340</b>
Internal/external corner for profile	1 pair (1x internal, 1x external)	Grey plastic	<b>712.63.530</b>	<b>340</b>
<b>GOLA Original System C - Horizontal fixing between doors and drawers, with plastic connectors</b>				
Profile for horizontal fixing between doors and drawers	3.9 m length	Silver anodised aluminium	<b>126.47.900</b>	<b>341</b>
Profile connector, screw fixing	1 pair	Red plastic	<b>712.63.511</b>	<b>341</b>
Profile connector, dowel fixing	1 pair	Red plastic	<b>712.63.521</b>	<b>341</b>
Exterior trim caps	1 pair	Grey plastic	<b>126.47.590</b>	<b>341</b>
Interior trim caps	1 pair	Grey plastic	<b>126.47.591</b>	<b>341</b>
Internal/external corner for profile	1 pair (1x internal, 1x external)	Grey plastic	<b>126.47.592</b>	<b>341</b>
<b>GOLA System B Plus - Horizontal fixing under worktops, with profile aluminium connectors</b>				
Profile for horizontal fixing under worktops	4.1 m length	Silver anodised aluminium	<b>126.36.940</b>	<b>342</b>
Trim caps	1 pair	Silver anodised aluminium	<b>126.36.947</b>	<b>342</b>
Profile connector for internal corners	1 pair	Silver anodised aluminium	<b>126.36.946</b>	<b>342</b>
Profile connector, screw fixing	1 pair	Red plastic	<b>712.63.511</b>	<b>342</b>
Profile connector, dowel fixing	1 pair	Red plastic	<b>712.63.521</b>	<b>342</b>
<b>GOLA System C Plus - Horizontal fixing between doors and drawers, with profile aluminium connectors</b>				
Profile for horizontal fixing between doors and drawers	4.1 m length	Silver anodised aluminium	<b>126.36.950</b>	<b>343</b>
Trim caps	1 pair	Silver anodised aluminium	<b>126.36.986</b>	<b>343</b>
Profile connector for internal corners	1 pair	Silver anodised aluminium	<b>126.36.985</b>	<b>343</b>
Profile connector for external corners	1 pair	Silver anodised aluminium	<b>126.37.916</b>	<b>343</b>
Profile connector, screw fixing	1 pair	Red plastic	<b>712.63.511</b>	<b>343</b>
Profile connector, dowel fixing	1 pair	Red plastic	<b>712.63.521</b>	<b>343</b>
<b>GOLA System D - Vertical fixing between doors</b>				
End profile for vertical fixing between cabinet and door	2.67 m length	Silver anodised aluminium	<b>126.36.972</b>	<b>344</b>
Profile for vertical fixing between doors	2.67 m length	Silver anodised aluminium	<b>126.36.962</b>	<b>344</b>
Profile for vertical fixing between cabinet and oven	2.67 m length	Silver anodised aluminium	<b>126.38.910</b>	<b>345</b>
Vertical profiles, spacer set for vertical profiles	1 set	Zinc plated steel	<b>126.36.958</b>	<b>345</b>
<b>GOLA System E - Vertical fixing between doors</b>				
End profile for vertical fixing between cabinet and door	2.4 m length	Silver anodised aluminium	<b>126.37.962</b>	<b>346</b>
Profile for vertical fixing between doors	2.4 m length	Silver anodised aluminium	<b>126.37.942</b>	<b>346</b>
Profile for vertical fixing between cabinet and oven	580 mm length	Silver anodised aluminium	<b>126.37.891</b>	<b>347</b>
<b>Co-ordinating aluminium plinths</b>				
Plinth panel	3.0 m length	Silver anodised aluminium	<b>713.35.401</b>	<b>349</b>
Plinth protector, linear	1 pair	Silver anodised aluminium	<b>781.34.996</b>	<b>349</b>
Plinth connector, 90° or end connector	1 pair	Silver anodised aluminium	<b>781.34.997</b>	<b>349</b>
Plinth clip	1 set	Black plastic	<b>713.28.540</b>	<b>349</b>

## GOLA Original System C Plus dishwasher frame

To create the linear look of the kitchen. For fixing between the dishwasher front and the dishwasher doors

AT A GLANCE

KITCHEN APPLICATIONS

BEDROOM APPLICATIONS

BATHROOM APPLICATIONS

HANDLE FREE APPLICATIONS

INSTALLATION & DISPLAY

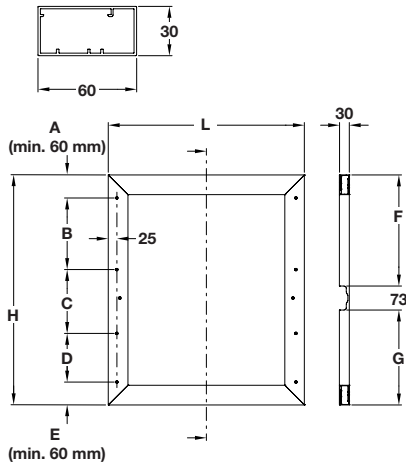

### GOLA System C Plus dishwasher frame

- > To create the linear look of the kitchen, why not use the GOLA System C Plus profile even on the dishwasher door
- > To be fixed between the dishwasher front and the dishwasher doors
- > Anodised aluminium with a stainless steel look to match the dishwasher front
- > Order qty: 1 pc (1 pc = 580 mm length)



Length x Width	Cat. No.
690 x 596 mm	126.36.730

➔ Order System C Plus profile section and end caps separately, shown on page 343

# GOLA System A

For horizontal fixing under wall units

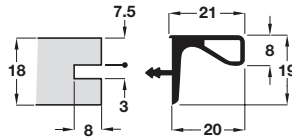
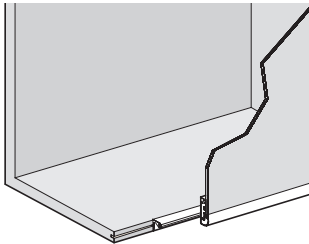

## GOLA System A profile, for horizontal fixing under wall units, without soft lip shock absorber

- > For fixing under wall units
- > Aluminium
- > Without soft lip shock absorber
- > Order qty: 1 pc (1 pc = 3.9 m length)

Finish	Cat. No.
● Silver anodised	126.48.900

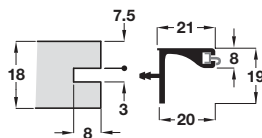
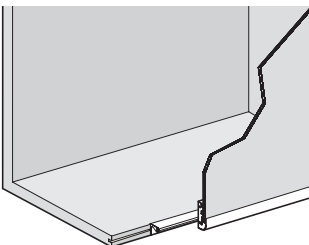

## GOLA System A profiles, for horizontal fixing under wall units, with soft lip shock absorber

- > For fixing under wall units
- > Aluminium
- > With soft lip shock absorber
- > Order qty: 1 pc (1 pc = 3.9 m length)

Finish	Cat. No.
● Silver anodised	126.48.910

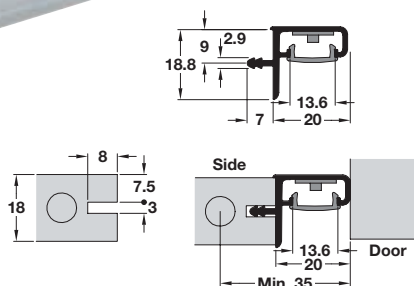
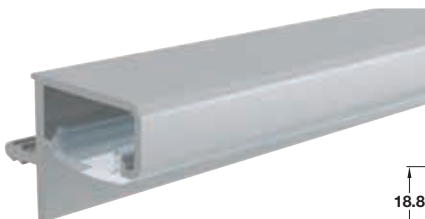

## GOLA System A profiles, for horizontal fixing under wall units, with slot for LED strip

- > Horizontal aluminium profile suitable for use with 18 mm thick wall cabinets. Complete with a slot for LED strip lighting
- > For fixing under wall units
- > Aluminium
- > With translucent diffuser
- > Order qty: 1 pc (1 pc = 4.1 m length)

Finish	Cat. No.
● Silver anodised	126.48.920

FURNITURE HANDLES 2021, © Häfele U.K. Ltd 2021. Dimensional data not binding. We reserve the right to alter specifications without notice.

## GOLA Original System B

For horizontal fixing under worktops, with plastic connectors

➔ Order connectors and caps separately, shown below

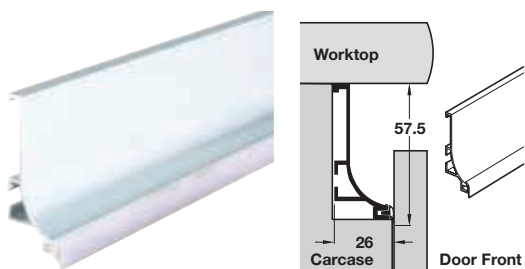

### GOLA Original system B profile, for horizontal fixing under worktops

- > For fixing between the worktop and door or drawer
- > Anodised aluminium
- > Order qty: 1 pc (1 pc = 3.9 m length)

Finish	Cat. No.
 Anodised	712.63.900

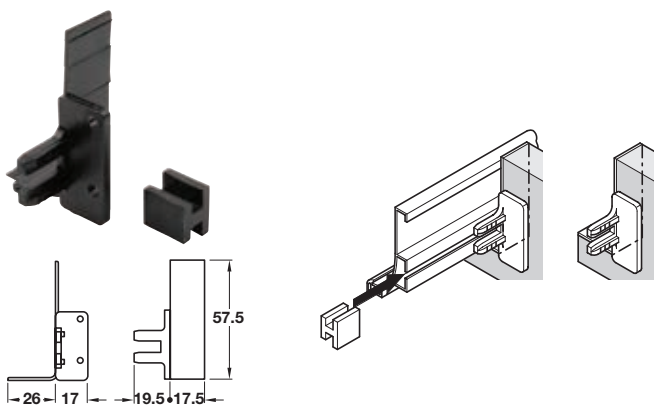

### GOLA Original system B profile connector with end panel cover

- > For connecting profile to cabinet inside panel
- > With end panel cover
- > Black plastic
- > Order qty: 1 pair

Type	Cat. No.
Screw fixing	712.63.510

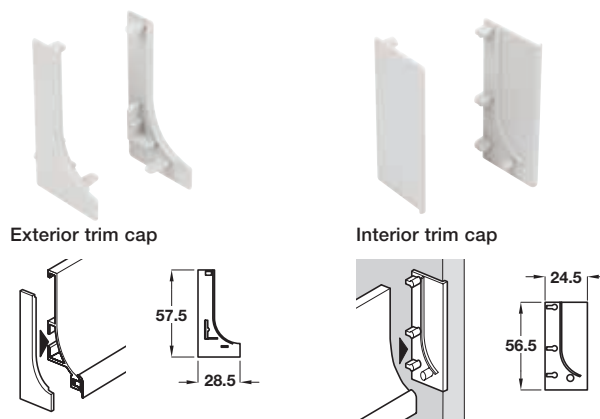

### GOLA Original system B profile trim caps

- > Grey plastic
- > Order qty: 1 pair

Type	Cat. No.
Exterior trim caps	712.63.540
Interior trim caps	712.63.541

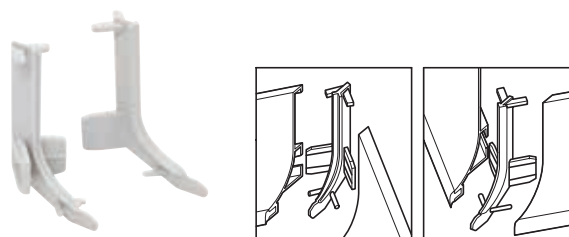

### Internal/external corner for profile

- > For connecting profile, for internal or external corners
- > Grey plastic
- > Order qty: 1 pair (1x internal, 1x external)

Type	Cat. No.
Corner for profile	712.63.530

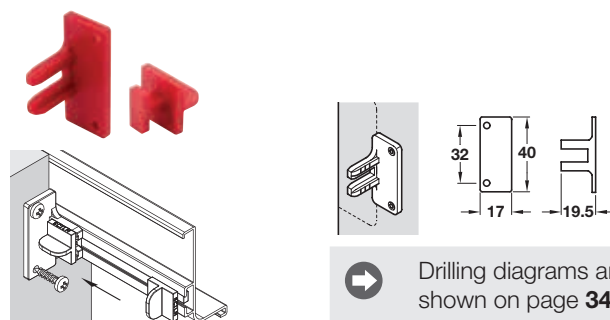

➔ Drilling diagrams are shown on page 341

### GOLA System B/C Plus profile connector

- > For connecting profile to cabinet inside panel
- > Red plastic
- > Order qty: 1 pair

Type	Cat. No.
Screw fixing	712.63.511

# GOLA Original System C

For horizontal fixing between doors and drawers, with plastic connectors

➔ Order connectors and caps separately, shown below

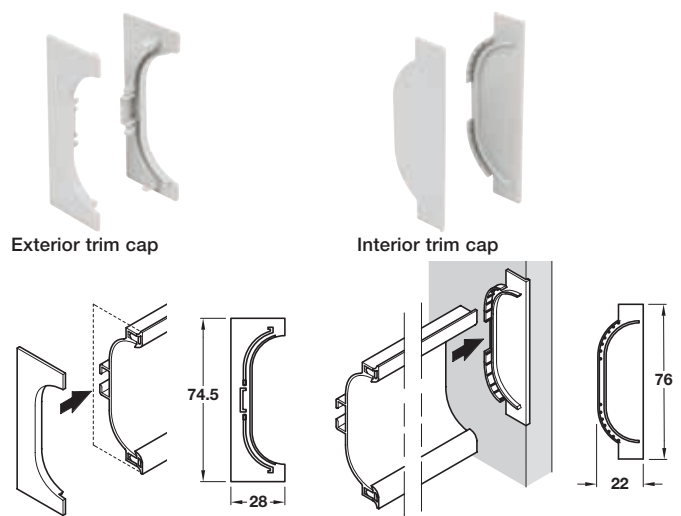
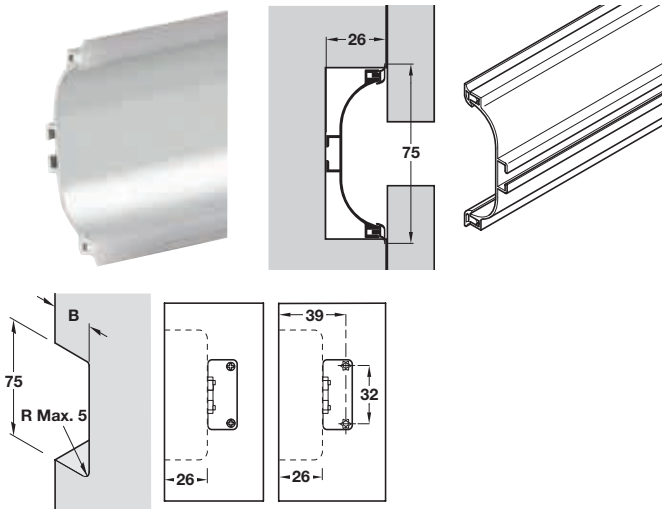

## GOLA Original system C profile, for horizontal fixing between doors and drawers

- > For fixing between doors and drawers
- > Anodised aluminium
- > Order qty: 1 pc (1 pc = 3.9 m length)

Finish	Cat. No.
● Anodised	126.47.900

## GOLA Original system C profile trim caps

- > Grey plastic
- > Order qty: 1 pair

Type	Cat. No.
Exterior trim caps	126.47.590
Interior trim caps	126.47.591



Screw fixing

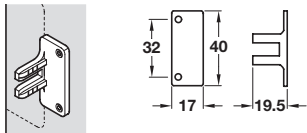

Dowel fixing

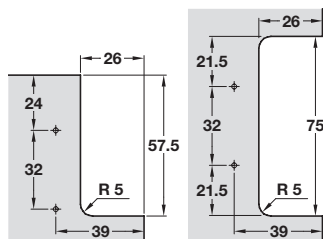
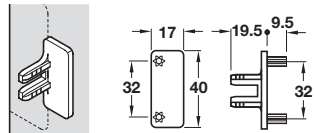

Screw fixing drilling diagram

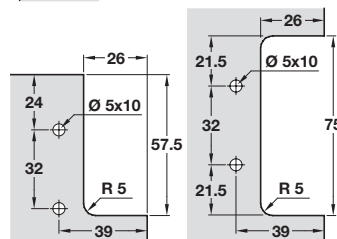

Dowel fixing drilling diagram

## GOLA System B/C profile connector

- > For connecting profile to cabinet inside panel
- > Screw or dowel fixing
- > Red plastic
- > Order qty: 1 pair

Type	Cat. No.
Screw fixing	712.63.511
Dowel fixing	712.63.521

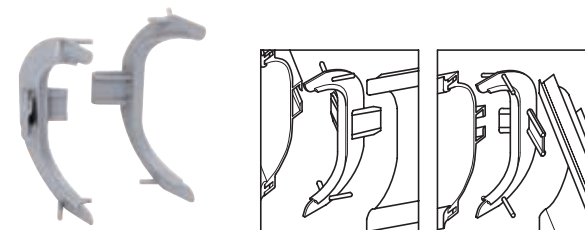

## Internal/external corners

- > For connecting profiles, for internal or external corners
- > Grey plastic
- > Order qty: 1 pair (1x internal, 1x external)

Type	Cat. No.
Internal/external corners	126.47.592

FURNITURE HANDLES 2021, © Häfele U.K. Ltd 2021. Dimensional data not binding. We reserve the right to alter specifications without notice.

## GOLA System B Plus

For horizontal fixing under worktops, with profile aluminium connectors



Order connectors and caps separately, shown below

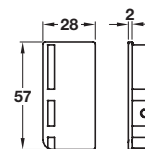
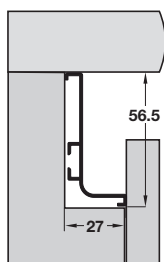

### GOLA System B Plus profile, for horizontal fixing under worktops

- > For fixing between the worktop and door or drawer
- > Aluminium
- > Order qty: 1 pc (= 4.1 m length)

### GOLA System B Plus trim caps

- > Aluminium
- > Order qty: 1 pair

Finish	Cat. No.
Silver anodised	126.36.940
Bronze anodised	126.36.104
Graphite powder coated	126.36.704
Brushed brass anodised	126.35.505
Brushed copper anodised	126.36.804
Matt white powder coated	126.36.941
Matt black powder coated	126.36.942

Finish	Cat. No.
Silver anodised	126.36.947
Bronze anodised	126.36.180
Graphite powder coated	126.36.780
Brushed brass anodised	126.36.589
Brushed copper anodised	126.36.880
Matt white powder coated	126.36.948
Matt black powder coated	126.36.949



Design may differ; function is not affected

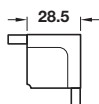

### GOLA System B Plus profile connectors for internal corners

- > Aluminium
- > Order qty: 1 pc

Finish	Cat. No.
Silver anodised	126.36.946
Bronze anodised	126.36.181
Graphite powder coated	126.36.781
Brushed brass anodised	126.36.585
Brushed copper anodised	126.36.881
Matt white powder coated	126.36.951
Matt black powder coated	126.36.952

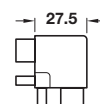

### GOLA System B Plus profile connectors for external corners

- > Aluminium
- > Order qty: 1 pc

Finish	Cat. No.
Silver anodised	126.36.945
Bronze anodised	126.36.182
Graphite powder coated	126.36.782
Brushed brass anodised	126.36.587
Brushed copper anodised	126.36.882
Matt white powder coated	126.36.944
Matt black powder coated	126.36.943



# GOLA System C Plus

For horizontal fixing between doors and drawers, with aluminium profile connectors



Order connectors and caps separately, shown below

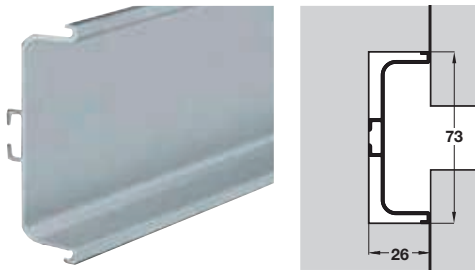

## GOLA System B Plus profile, for horizontal fixing under worktops

- > Aluminium
- > Order qty: 1 pc (= 4.1 m length)

Finish	Cat. No.
Silver anodised	126.36.950
Bronze anodised	126.36.114
Graphite powder coated	126.36.714
Brushed brass anodised	126.36.515
Brushed copper anodised	126.36.814
Matt white powder coated	126.36.953
Matt black powder coated	126.36.954

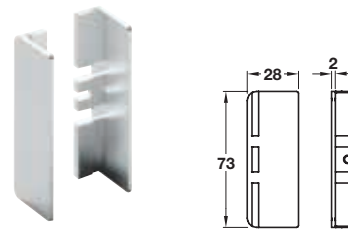

## GOLA System C Plus trim caps

- > Aluminium
- > Order qty: 1 pair

Finish	Cat. No.
Silver anodised	126.36.986
Bronze anodised	126.36.183
Graphite powder coated	126.36.783
Brushed brass anodised	126.36.560
Brushed copper anodised	126.36.883
Matt white powder coated	126.36.987
Matt black powder coated	126.36.988

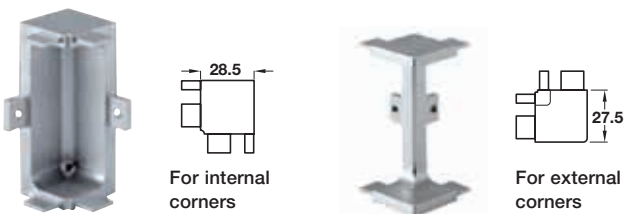

## GOLA System C Plus profile connector for internal or external corners

- > Aluminium
- > Order qty: 1 pc

Finish	Internal	External
Silver anodised	126.36.985	126.37.916
Bronze anodised	126.36.184	126.37.915
Graphite powder coated	126.36.784	126.37.917
Brushed brass anodised	126.36.586	126.37.920
Brushed copper anodised	126.36.884	126.37.919
Matt white powder coated	126.36.984	126.37.914
Matt black powder coated	126.36.983	126.37.913

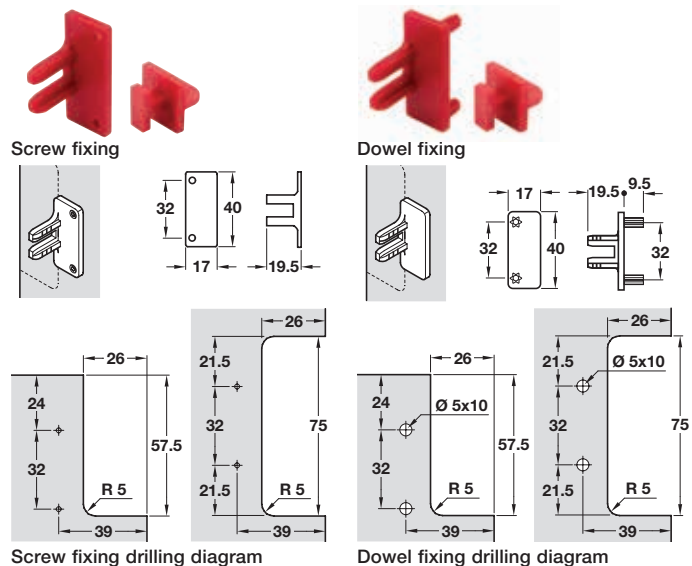

## GOLA System B/C Plus profile connector

- > For connecting profile to cabinet inside panel
- > Screw or dowel fixing
- > Red plastic
- > Order qty: 1 pair

Type	Cat. No.
Screw fixing	712.63.511
Dowel fixing	712.63.521

FURNITURE HANDLES 2021, © Häfele U.K. Ltd 2021. Dimensional data not binding. We reserve the right to alter specifications without notice.

## GOLA System D

For vertical fixing between doors

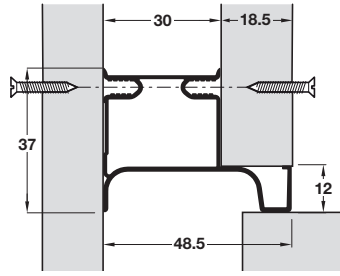

### GOLA System D end profile, for vertical fixing between cabinet and door

- > For fixing between the cabinet and door
- > Order fixing screws separately
- > Aluminium
- > Order qty: 1 pc (= 2.67 m length)



Finish	Cat. No.
Silver anodised	<b>126.36.972</b>
Bronze anodised	<b>126.36.872</b>
Graphite powder coated	<b>126.36.772</b>
Brushed brass anodised	<b>126.36.573</b>
Brushed copper anodised	<b>126.36.172</b>
Matt white powder coated	<b>126.36.973</b>
Matt black powder coated	<b>126.36.974</b>

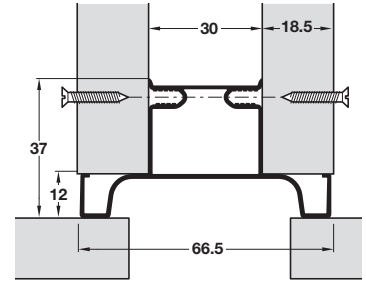

### GOLA System D profile, for vertical fixing between doors

- > For fixing between doors
- > Order fixing screws separately
- > Aluminium
- > Order qty: 1 pc (= 2.67 m length)



Finish	Cat. No.
Silver anodised	<b>126.36.962</b>
Bronze anodised	<b>126.36.862</b>
Graphite powder coated	<b>126.36.762</b>
Brushed brass anodised	<b>126.36.563</b>
Brushed copper anodised	<b>126.36.162</b>
Matt white powder coated	<b>126.36.963</b>
Matt black powder coated	<b>126.36.964</b>

**!** When cutting aluminium a normal chop saw with a good blade for aluminium is needed  
As a final step, a fine polishing with sanding paper is usually required as well as cleaning with compressed air



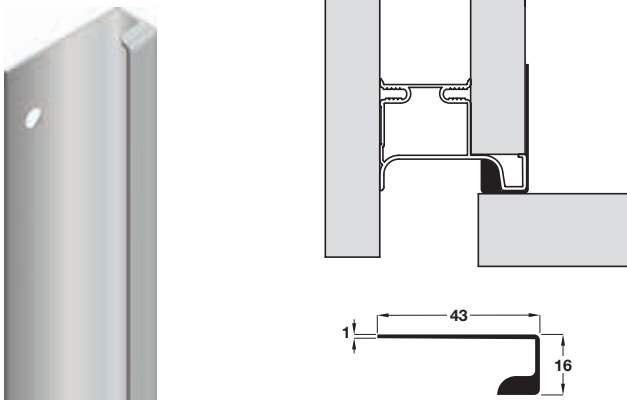

### GOLA System D profile, for vertical fixing between cabinet and oven

- > For fixing between the cabinet and oven
- > Order fixing screws separately
- > Aluminium
- > Order qty: 1 pc (= 580 mm length)



Finish	Cat. No.
Silver anodised	126.38.910
Bronze anodised	126.38.810
Graphite powder coated	126.38.710
Brushed brass anodised	126.38.511
Brushed copper anodised	126.38.110
Matt white powder coated	126.38.912
Matt black powder coated	126.38.913

Order System D (end profile or between doors profile) separately, shown on page 344

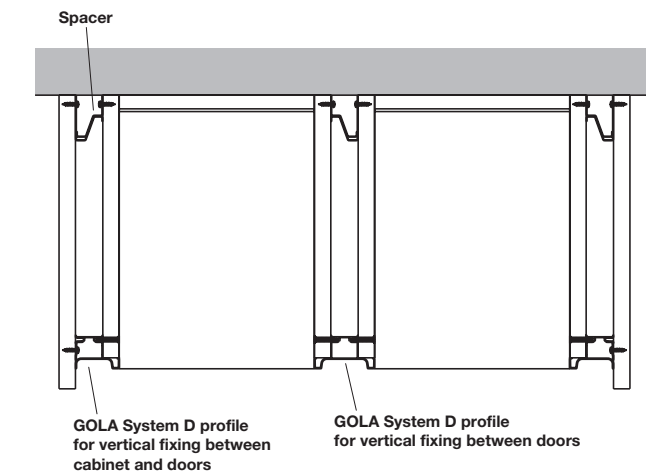
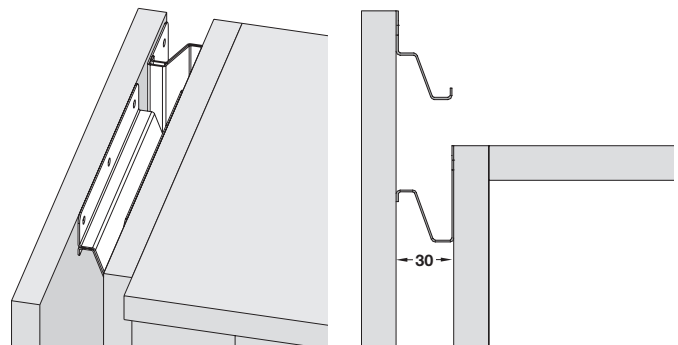

### Spacer set for System D vertical profiles

- > Spacer set for System D vertical profiles, to provide 30 mm rear spacing
- > Set includes:
  - 1x left hand bracket, 30 x 150 mm
  - 1x right hand bracket, 30 x 150 mm
  - 6x Ø 3.5 x 16 mm screws, zinc plated steel
- > Zinc plated steel
- > Order qty: 1 set



Type	Cat. No.
Spacer set	126.36.958

For use with GOLA System D vertical profiles, shown on page 344

## GOLA System E

For vertical fixing between doors

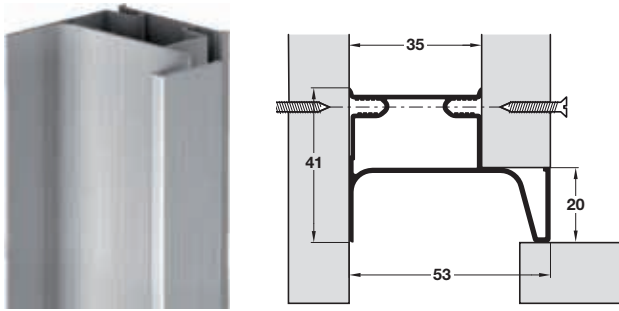

**GOLA System E end profile, for vertical fixing between cabinet and door**

- > For fixing between the cabinet and door
- > Order fixing screws separately
- > Aluminium
- > Order qty: 1 pc (2.4 m length)



Finish	Cat. No.
Silver anodised	126.37.962
Bronze anodised	126.36.122
Graphite powder coated	126.37.762
Brushed brass anodised	126.37.563
Brushed copper anodised	126.37.162
Matt white powder coated	126.37.963
Matt black powder coated	126.37.964

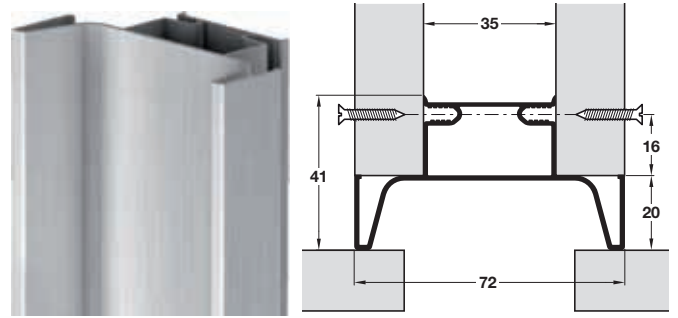

**GOLA System E profile, for vertical fixing between doors**

- > For fixing between doors
- > Order fixing screws separately
- > Aluminium
- > Order qty: 1 pc (2.4 m length)



Finish	Cat. No.
Silver anodised	126.37.942
Bronze anodised	126.36.132
Graphite powder coated	126.37.742
Brushed brass anodised	126.37.543
Brushed copper anodised	126.37.142
Matt white powder coated	126.37.943
Matt black powder coated	126.37.944

**!** When cutting aluminium a normal chop saw with a good blade for aluminium is needed  
As a final step, a fine polishing with sanding paper is usually required as well as cleaning with compressed air



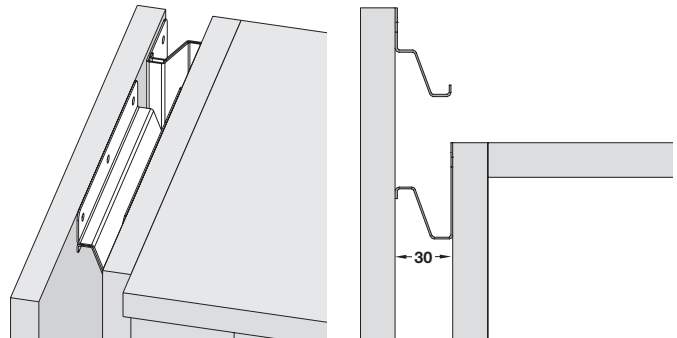
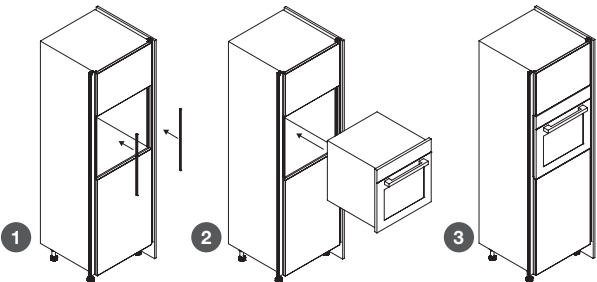
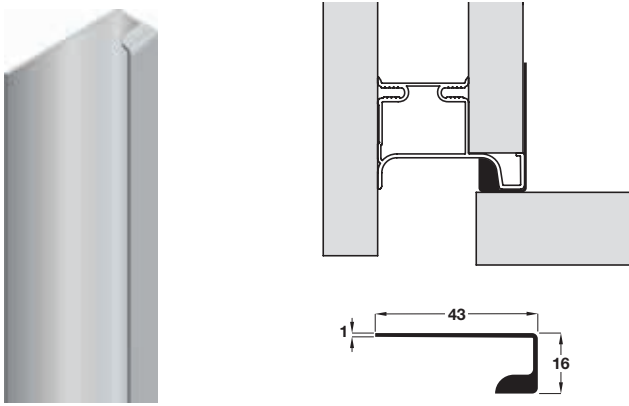

### GOLA System E profile, for vertical fixing between cabinet and oven

- > For fixing between the cabinet and oven
- > Order fixing screws separately
- > Aluminium
- > Order qty: 1 pc (= 580 mm length)



Finish	Cat. No.
Silver anodised	126.37.891
Bronze anodised	126.37.890
Graphite powder coated	126.37.892
Brushed brass anodised	126.37.897
Brushed copper anodised	126.37.894
Matt white powder coated	126.37.895
Matt black powder coated	126.37.896

Order System E end profile for vertical fixing between cabinet and door separately, shown on page 346

Use spacer Cat. No. 126.36.958 for the system E profiles alongside the use of washers, shown left

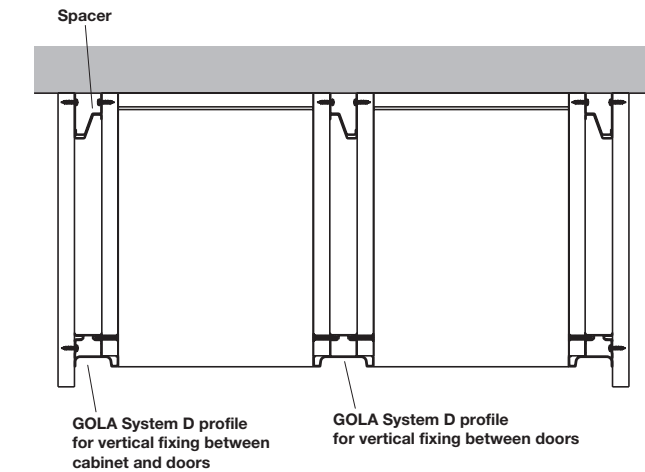

### Spacer set for System E vertical profiles

- > Spacer set for System E vertical profiles, to provide 30 mm rear spacing
- > Set includes:
  - 1x left hand bracket, 30 x 150 mm
  - 1x right hand bracket, 30 x 150 mm
  - 6x Ø 3.5 x 16 mm screws, zinc plated steel
- > Zinc plated steel
- > Order qty: 1 set



Type	Cat. No.
Spacer set	126.36.958

## Aluminium Plinth Panels

Combine the plinth panel set, plinth clip set and the plinth connector to create a stylish yet simple plinth system

AT A GLANCE

KITCHEN APPLICATIONS

BEDROOM APPLICATIONS

BATHROOM APPLICATIONS

HANDLE FREE APPLICATIONS

INSTALLATION & DISPLAY



Silver anodised



Graphite powder coated



Bronze anodised



Brushed brass anodised



Brushed copper anodised



Graphite powder coated version shown

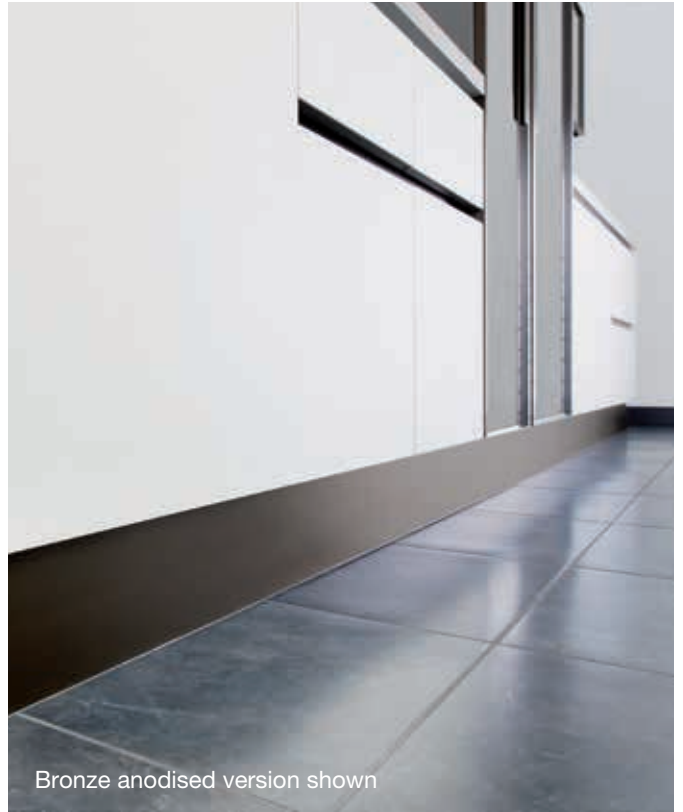

Bronze anodised version shown



Brushed copper anodised version shown



Brushed brass anodised version shown

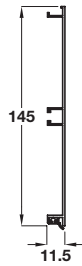

### Aluminium plinth panel

- > 3000 mm length
- > Includes finishing strip for 150 mm high plinth
- > Aluminium
- > Order qty: 1 pc

Finish	Cat. No.
Silver anodised	713.35.401
Bronze anodised	713.35.101
Graphite powder coated	713.35.301
Brushed brass anodised	713.35.601
Brushed copper anodised	713.35.801

➔ Order plinth connectors and clips separately, shown below

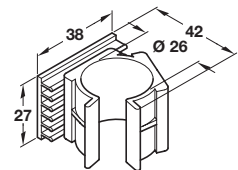
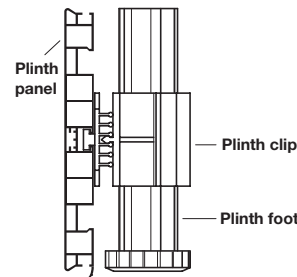

### Plinth clip

- > For use with PVC plinth panel 713.28.515
- > Can also be used with aluminium plinth panel shown above
- > Plastic
- > Order qty: 1 set (order in multiples of 12 sets)

Finish	Cat. No.
Black	713.28.540

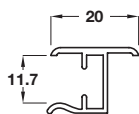

### Plinth connector, linear

- > 146 mm high for plinth 150 mm
- > For use with aluminium plinth panels, shown above
- > Aluminium
- > Order qty: 1 pair

Finish	Cat. No.
Silver anodised	781.34.996
Bronze anodised	781.34.196
Graphite powder coated	781.34.396
Brushed brass anodised	781.34.696
Brushed copper anodised	781.34.896

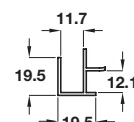

### Plinth connector, 90° or end connector

- > 146 mm high for plinth 150 mm
- > For use with aluminium plinth panels, shown above
- > Aluminium
- > Order qty: 1 pair

Finish	Cat. No.
Silver anodised	781.34.997
Bronze anodised	781.34.197
Graphite powder coated	781.34.397
Brushed brass anodised	781.34.697
Brushed copper anodised	781.34.897

## Installation Tools

A simple jig which accurately marks out door and drawer fronts in preparation for fixing handles and knobs

AT A GLANCE

KITCHEN APPLICATIONS

BEDROOM APPLICATIONS

BATHROOM APPLICATIONS

HANDLE FREE APPLICATIONS

INSTALLATION & DISPLAY

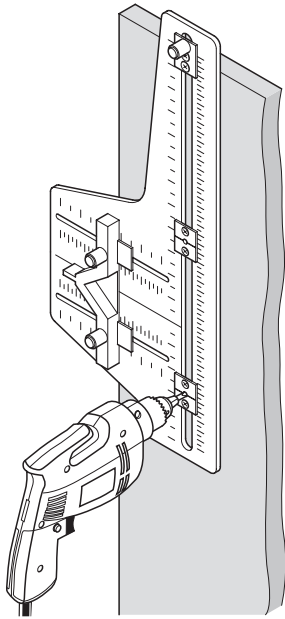

For drilling on doors or flaps

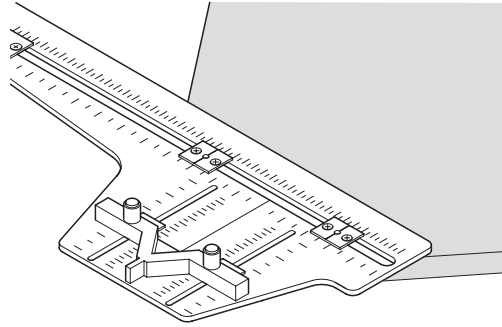

For drilling on flaps at 45° angle

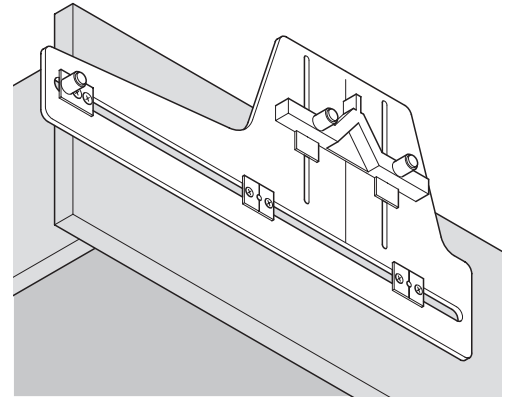

For drilling on panels

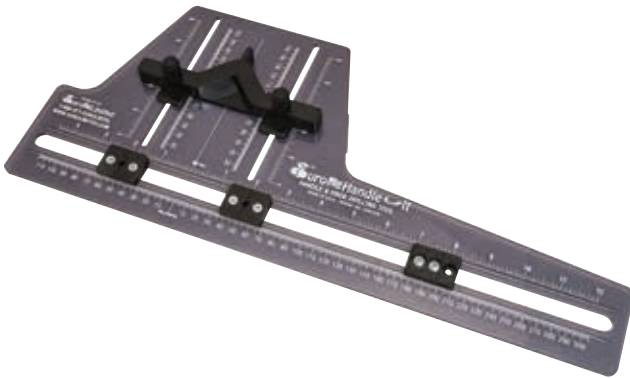

### Handle and knob drilling jig

- > V-notch in fence for use in installing handles at a 45° angle
- > Imperial and metric scales for use on all handles
- > Height adjustment to the centre of a 300 mm high drawer front
- > Movable positioning stop for use on drawer fronts of the same size
- > Installs handles as large as 600 mm
- > Made of polycarbonate (jet aircraft canopy material), this jig is virtually unbreakable
- > Order qty: 1 pc

Item	Cat. No.
Drilling jig	<b>001.35.001</b>





**Step 1**  
Firstly, determine the distance from the top of the door where the first hole is required



**Step 2**  
Then determine the distance from the side of the door where the first hole is required



**Step 3**  
Using either a 2 mm pilot drill bit or an awl, mark the door where the first hole is required



**Step 4**  
For a standard hole centre, simply read off the scale the desired hole centres and mark the door with the position of the second hole



**Step 5**  
The jig is now set up for all doors in the kitchen and each door can quickly be marked out ready for drilling



### Handle jig

- > Simple jig which accurately marks out door and drawer fronts in preparation for fixing handles and knobs
- > Green/black plastic - colour may vary
- > Order qty: 1 pc

Item	Cat. No.
Door handle jig	001.35.030

## Care & Maintenance

We advocate the use of a dry cloth only to clean handles. Please do not under any circumstances use any form of metal cleaner or aerosol spray. Our microfibre cloth is perfect for cleaning all types of handles and knobs without using chemicals that could damage the surface finish



### AluSplash microfibre cloth

- > 310 x 285 mm
- > Perfect for use with VuPlex® plastic cleaner
- > Order qty: 1 pc

Colour	Cat. No.
Blue	007.32.135

## Handle Display Boards



### Handle display boards

- > Light grey MDF
- > Handles not included
- > Order qty: 1 pc

Handle board	Height x Width	Cat. No.
Small	500 x 500 mm	<b>Special order</b>
Large	1000 x 500 mm	<b>Special order</b>

➔ Speak to your Häfele Account Manager for more information

## Handle Screws and Pins

Don't forget to order your non-metric cut off screws or round-head metal pins

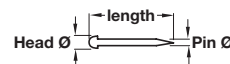
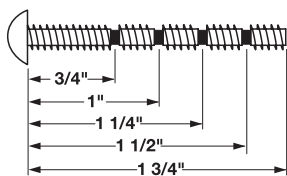

### Round-head metal pin

- > Steel
- > Order qty: 1 x 0.5 kg pack = approx. 10,000 pins

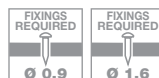

Finish	Head Ø x Pin Ø x Length	Cat. No.	Order Qty
Nickel plated	1.8 x 0.9 x 11 mm	<b>076.40.217</b>	1x 0.5 kg pack
	3.0 x 1.6 x 15 mm	<b>076.40.299</b>	
Brass plated	3.0 x 1.6 x 15 mm	<b>076.40.191</b>	1x 0.5 kg pack

### 8/32 Non-metric cut off screw

- > 8/32 = diameter/threads to the inch
- > Round head, install using a no. 2 Phillips cross slot screwdriver
- > Due to segmentation, screw can be cut to length
- > Yellow chromated steel

Length	Cat. No.	Order Qty
3/4 - 1 3/4"	<b>022.24.881</b>	100

# Handle Screws

Don't forget to order your M4 handle screws



**!** Please order screws in multiples of order quantity shown

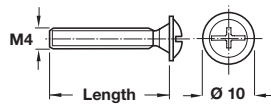

### M4 handle screw, standard pack

- > Flat head, with combi-cross slot
- > Zinc-plated steel
- > \*45 and 50 mm lengths with 35 mm thread lengths



Length	Cat. No.	Order Qty
M4 x 9 mm	<b>022.35.090</b>	100
M4 x 10 mm	<b>022.35.109</b>	100
M4 x 12 mm	<b>022.35.127</b>	100
M4 x 15 mm	<b>022.35.154</b>	100
M4 x 18 mm	<b>022.35.181</b>	100
M4 x 20 mm	<b>022.35.207</b>	100
M4 x 22 mm	<b>022.35.225</b>	100
M4 x 23 mm	<b>022.35.234</b>	100
M4 x 25 mm	<b>022.35.252</b>	100
M4 x 26 mm	<b>022.35.261</b>	100
M4 x 28 mm	<b>022.35.289</b>	100
M4 x 30 mm	<b>022.35.305</b>	100
M4 x 32 mm	<b>022.35.323</b>	100
M4 x 35 mm	<b>022.35.350</b>	100
M4 x 38 mm	<b>022.35.387</b>	100
M4 x 40 mm	<b>022.35.403</b>	100
M4 x 45 mm	<b>022.35.458*</b>	100
M4 x 50 mm	<b>022.35.501*</b>	100

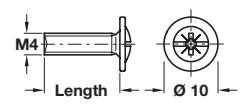

### M4 handle screw, bulk pack

- > Flat head, with combi-cross slot
- > These bulk packs offer great value
- > Zinc-plated steel



Length	Cat. No.	Order Qty
M4 x 9 mm	<b>022.45.090</b>	5000
M4 x 20 mm	<b>022.45.207</b>	5000
M4 x 22 mm	<b>022.45.225</b>	5000
M4 x 23 mm	<b>022.45.234</b>	5000
M4 x 25 mm	<b>022.45.252</b>	5000
M4 x 28 mm	<b>022.45.289</b>	5000
M4 x 32 mm	<b>022.45.323</b>	5000
M4 x 35 mm	<b>022.45.350</b>	5000
M4 x 38 mm	<b>022.45.387</b>	5000

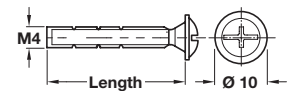

### M4 snap off screw

- > Flat head, with combi-cross slot
- > Due to segmentation, screw can be broken at 5 mm increments, shortest length 20 mm
- > Yellow chromated steel



Length	Cat. No.	Order Qty
M4 x 20-45 mm	<b>022.35.887</b>	100
M4 x 20-45 mm	<b>022.35.888</b>	50

# ASPEKT CABINET DOORS FROM HÄFELE

The Aspekt range of cabinet doors encompasses the best-selling styles on the market today at a range of price points to suit all budgets, all available for FREE delivery in 48-hours and with the backing of a Lifetime Guarantee and all the support you expect from Häfele.

View the full Aspekt cabinet doors range, visit [www.hafele.co.uk/aspekt-doors](http://www.hafele.co.uk/aspekt-doors)

## WHAT'S IN THE RANGE

Aspekt is a beautiful collection of the UK's favourite kitchen styles in a choice of 18 different door and finish combinations to suit any home.

- > 4 best-selling door styles
- > 11 on-trend colours and finishes
- > 40 sizes of door and drawer fronts
- > Full range of colour matched accessories
- > In stock, available for FREE\* 48-hour delivery
- > UK manufactured
- > FSC® certified
- > FIRA Gold Product Certification
- > Covered by the Häfele Lifetime Guarantee\*\*



\*On orders over £50

\*\*T&Cs apply. See [www.hafele.co.uk/aspekt-doors](http://www.hafele.co.uk/aspekt-doors) for details.

### DOOR TYPES



**Skye**  
Slab



**Stirling**  
J-Pull



**York**  
Shaker



**Hampstead**  
Acrylic Slab



Aspekt cabinet doors from Häfele - Stirling J-pull doors matt midnight blue

**© Häfele UK 2021**

No part of this catalogue may be reproduced,  
photocopied or stored in any data retrieval  
system without written permission.

# HÄFELE

10/2021-HÄFELE DECORATIVE HANDLES BROCHURE 2021 ISSUE 1

**Häfele UK Ltd** | Swift Valley Industrial Estate Rugby Warwickshire CV21 1RD Registered in England No. 1486136

**Phone:** 0800 171 2909 | **Fax:** 01788 544440 **Email:** info@hafele.co.uk **Technical:** 0800 171 2908

[www.hafele.co.uk](http://www.hafele.co.uk)