

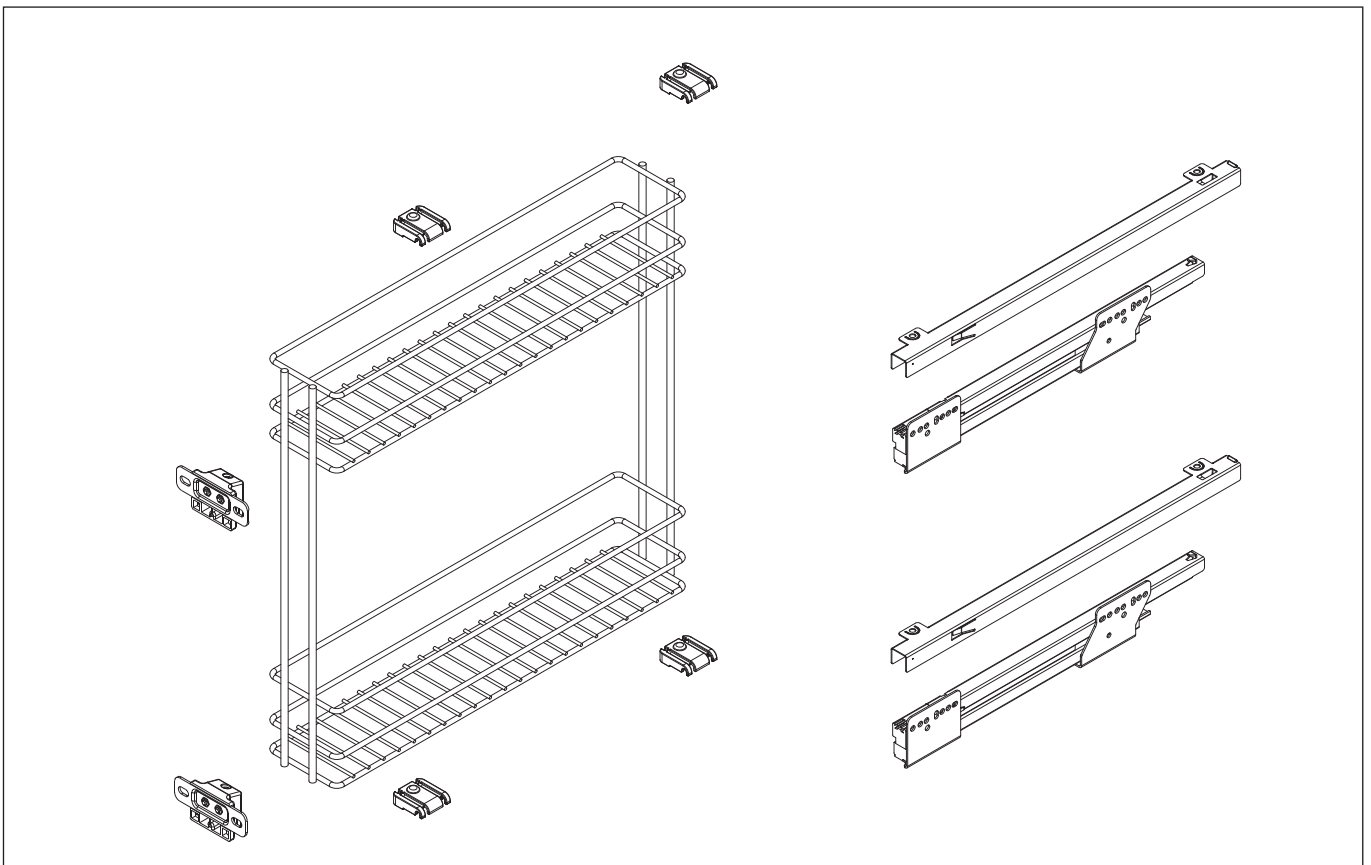

06 / 2015

ECO Pull-out K 150 K 200

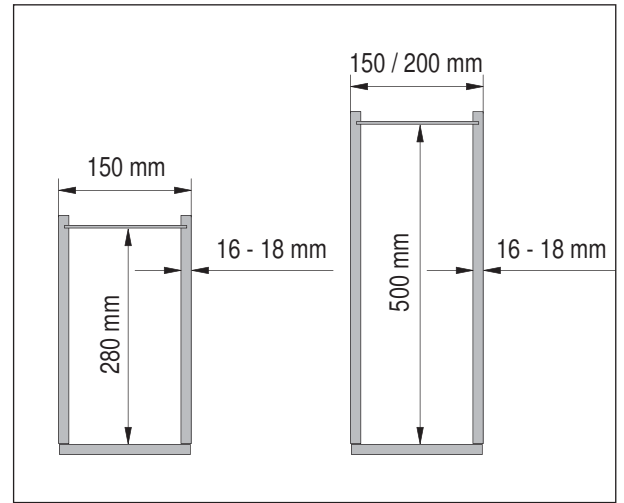

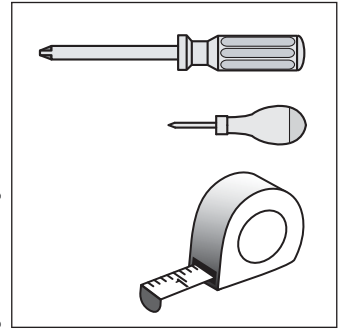
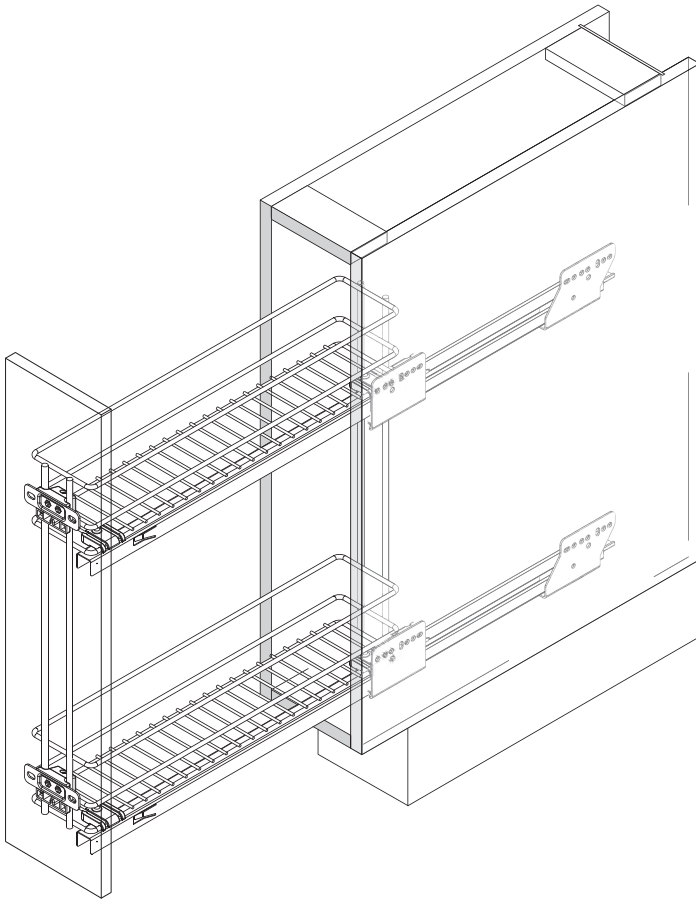

1

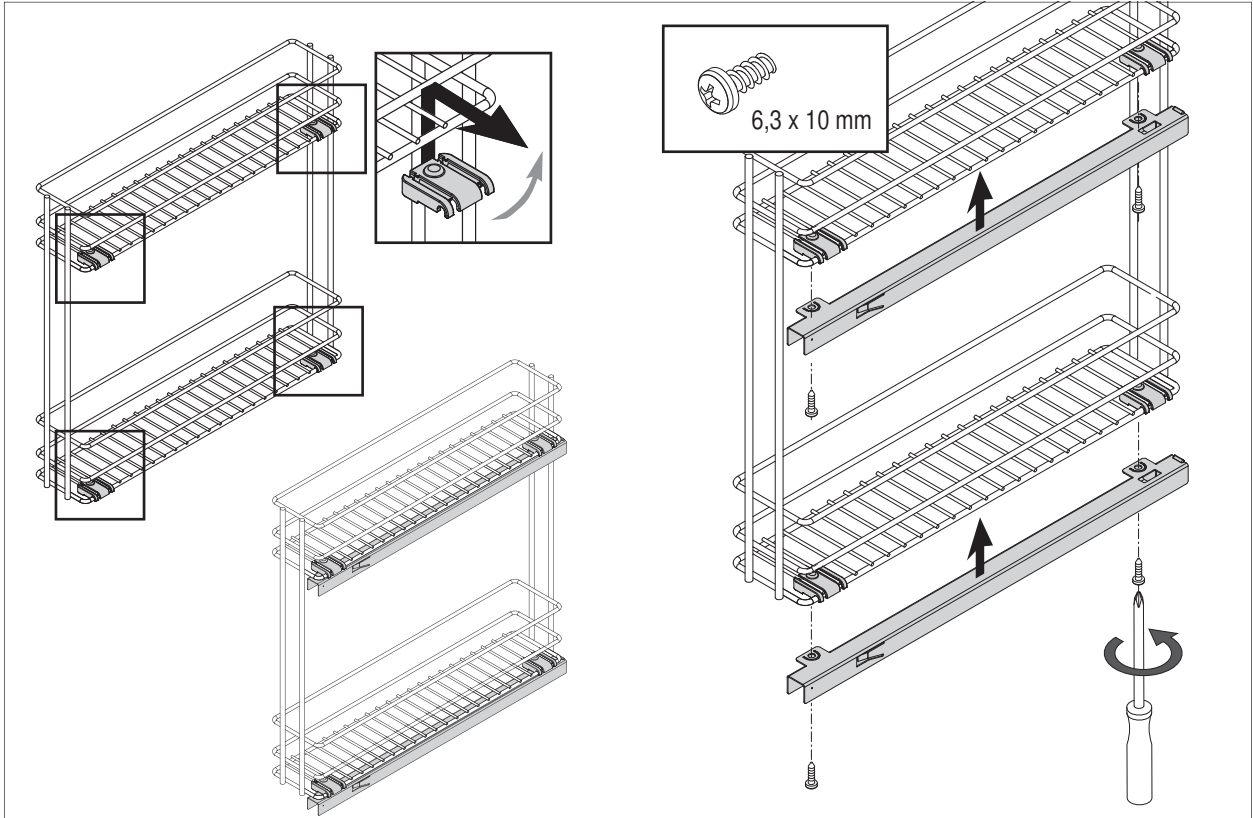

2

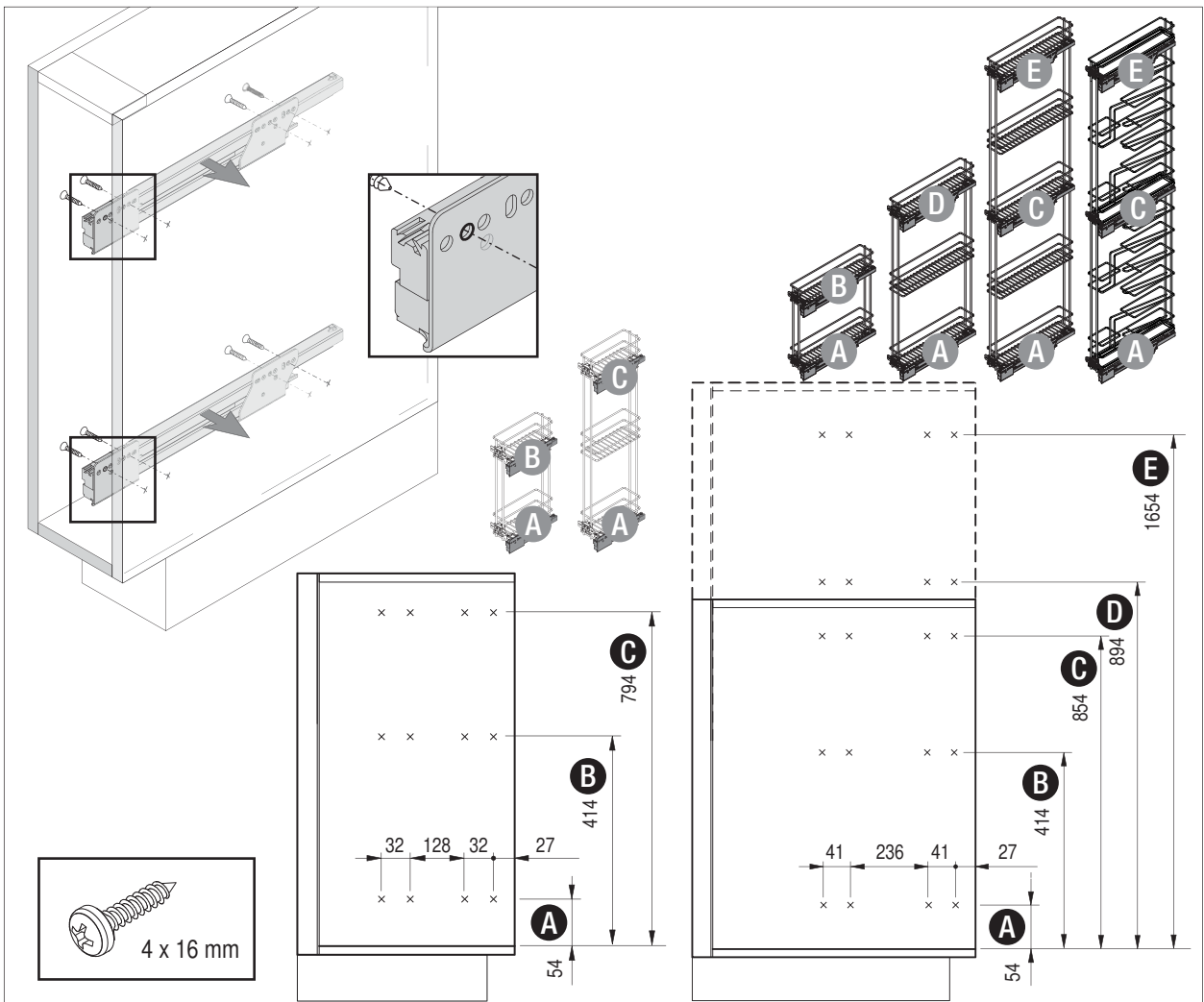

3

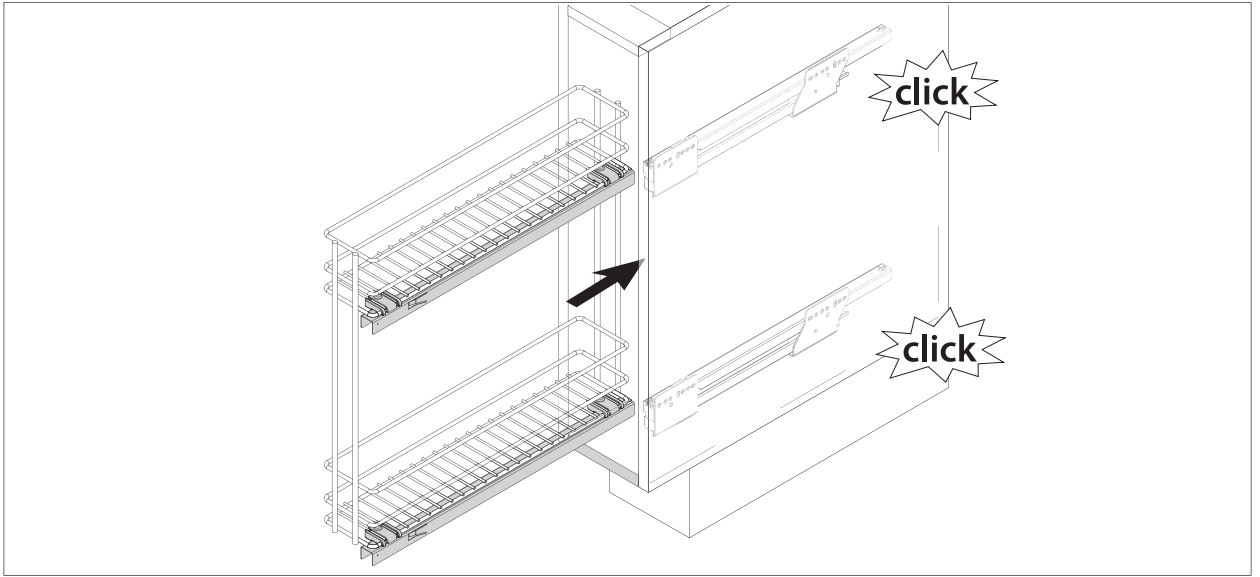

4

	K150	K200
Y	25	50



5

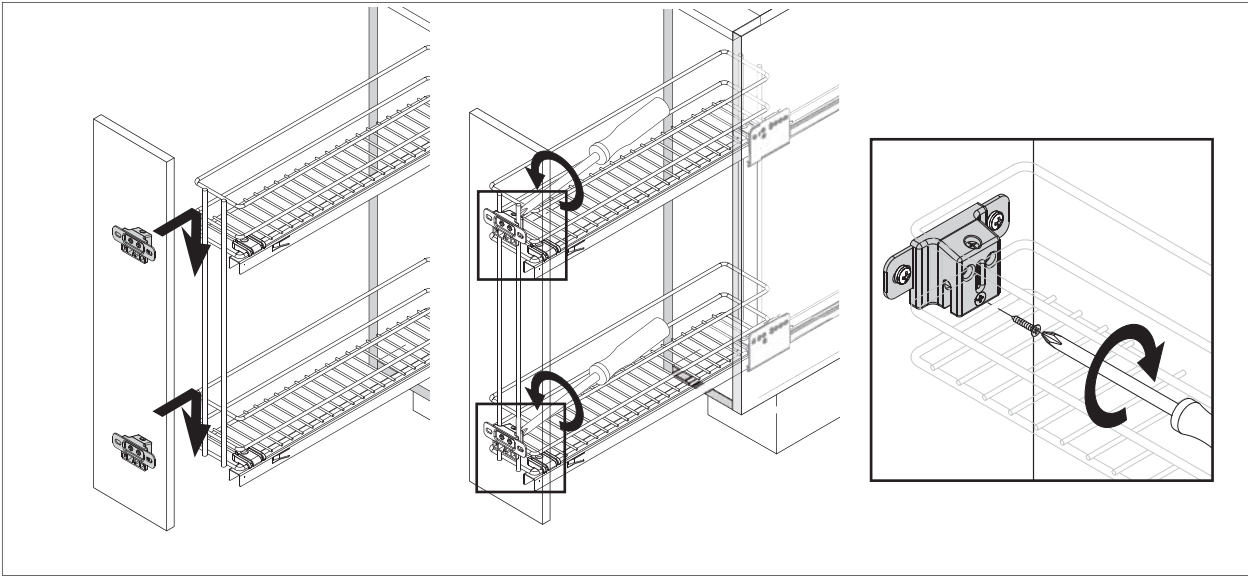

6

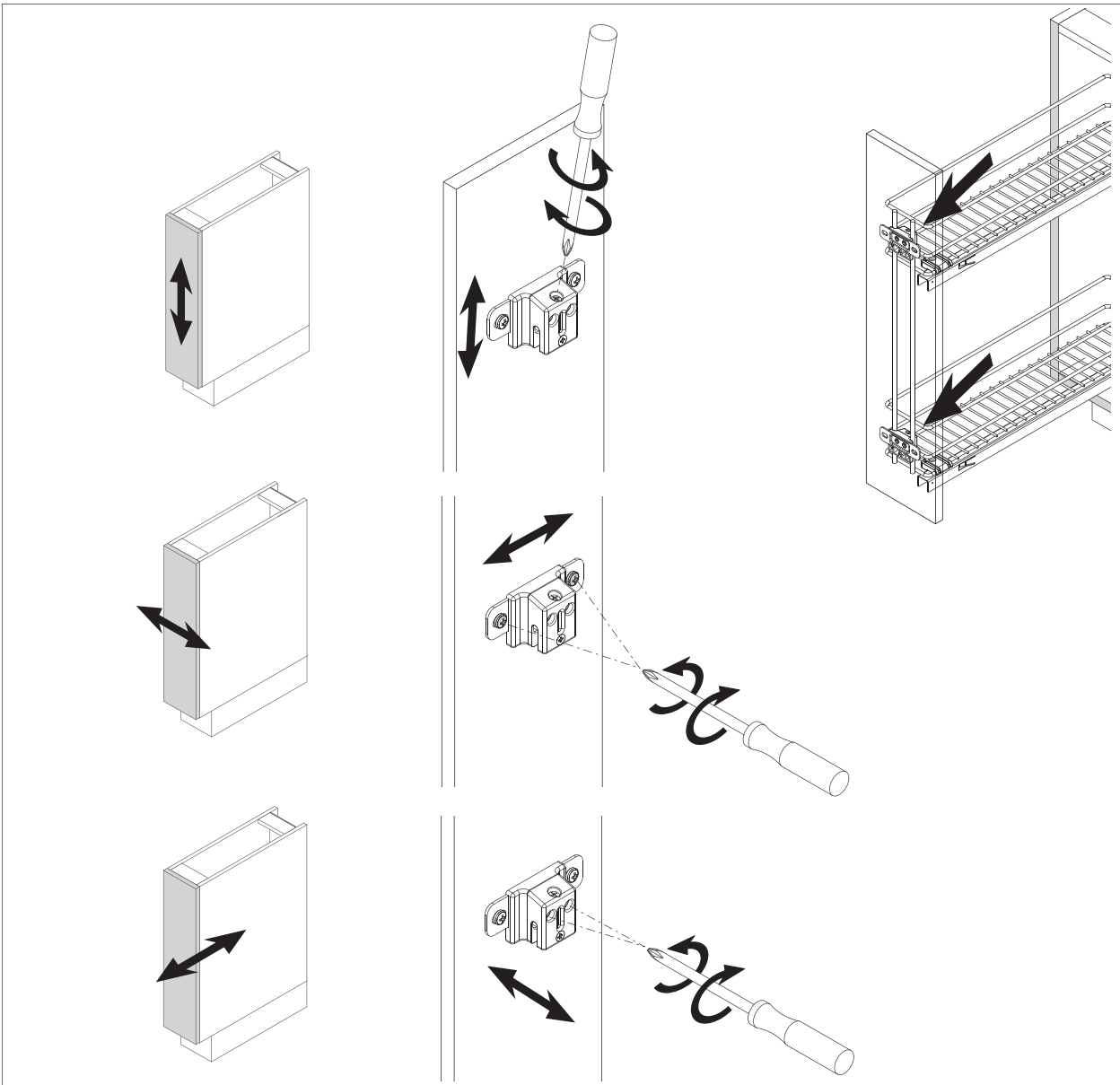

Vauth-Sagel

Neue Straße 27 · D-33034 Brakel-Erkeln · Telefon: +49 5272 601-01 · Fax: +49 5272 601-193 · Internet: www.vauth-sagel.de